

Owner's Manual
for Vehicle



The Ultimate
Driving Machine



X5 3.0si **Owner's Manual for Vehicle**

X5 4.8i

Congratulations, and thank you for choosing a BMW.

Thorough familiarity with your vehicle will provide you with enhanced control and security when you drive it. We therefore have this request:

Please take the time to read this Owner's Manual and familiarize yourself with the information that we have compiled for you before starting off in your new vehicle. It contains important data and instructions intended to assist you in gaining maximum use and satisfaction from your BMW's unique range of technical features. The manual also contains information on maintenance designed to enhance operating safety and contribute to maintaining the value of your BMW throughout an extended service life.

This manual is supplemented by a Service and Warranty Information Booklet for US models or a Warranty and Service Guide Booklet for Canadian models.

We wish you an enjoyable driving experience.

BMW AG

© 2007 Bayerische Motoren Werke
Aktiengesellschaft
Munich, Germany
Reprinting, including excerpts,
only with the written consent of
BMW AG, Munich.
Order No. 01 41 0 014 248
US English IX/07, 09 07 500
Printed in Germany
Printed on environmentally friendly paper,
bleached without chlorine, suitable for recycling.

Contents

The fastest way to find specific topics is to use the index, refer to page [270](#).

Using this Owner's Manual

- [4](#) Notes
- [7](#) Reporting safety defects

At a glance

- [10](#) Cockpit
- [16](#) iDrive
- [23](#) Voice command system

Controls

- [28](#) Opening and closing
- [42](#) Adjusting
- [55](#) Transporting children safely
- [59](#) Driving
- [71](#) Everything under control
- [84](#) Technology for comfort, convenience and safety
- [102](#) Lamps
- [106](#) Climate
- [115](#) Practical interior accessories

Driving tips

- [128](#) Things to remember when driving

Navigation

- [136](#) Starting navigation system
- [138](#) Destination entry
- [150](#) Destination guidance
- [159](#) What to do if ...

Entertainment

- [162](#) On/Off and settings
- [166](#) Radio
- [172](#) Satellite radio
- [175](#) CD player and CD changer
- [181](#) DVD changer
- [188](#) AUX-In connection
- [189](#) USB audio interface
- [192](#) DVD system in rear

Communications

- [208](#) Telephoning
- [223](#) BMW Assist

Mobility

- [232](#) Refueling
- [234](#) Wheels and tires
- [241](#) Under the hood
- [245](#) Maintenance
- [247](#) Replacing components
- [255](#) Giving and receiving assistance

Reference

- [262](#) Technical data
- [265](#) Short commands of voice command system
- [270](#) Everything from A to Z

Notes

Using this Owner's Manual

We have made every effort to ensure that you are able to find what you need in this Owner's Manual as quickly as possible. The fastest way to find specific topics is to refer to the detailed index at the back of the manual. If you wish to gain an initial overview of your vehicle, you will find this in the first chapter.

Should you sell your BMW some day, please remember to hand over the Owner's Manual as well; it is an important component of your vehicle.

Additional sources of information

If you have additional questions, your BMW Sports Activity Vehicle Center is always happy to advise you.

You can find information on BMW, e.g. on technology, on the Internet at www.bmwusa.com.

Symbols used

 Indicates precautions that must be followed precisely in order to avoid the possibility of personal injury and serious damage to the vehicle. ◀

 Indicates information that will assist you in gaining the optimum benefit from your vehicle and enable you to care more effectively for your vehicle. ◀

 Refers to measures that can be taken to help protect the environment. ◀

◀ Marks the end of a specific item of information.

* Indicates special equipment, country-specific equipment and optional extras, as well as equipment and functions not yet available at the time of printing.

"..." Identifies Control Display texts used to select individual functions.

›...‹ Verbal instructions to use with the voice command system.

››...‹‹ Identifies the answers generated by the voice command system.

Symbols on vehicle components

 Indicates that you should consult the relevant section of this Owner's Manual for information on a particular part or assembly.

The individual vehicle

When purchasing your BMW, you have decided in favor of a model with individualized equipment and features. This Owner's Manual describes the entire array of options and equipment available with a specific BMW model.

Please bear in mind that the manual may contain information on accessories and equipment that you have not specified for your own vehicle. Sections describing options and special equipment are marked by asterisks * to assist you in identifying possible differences between the descriptions in this manual and your own vehicle's equipment.

If equipment in your BMW is not described in this Owner's Manual, please refer to the accompanying Supplementary Owner's Manuals.

Editorial notice

BMW pursues a policy of continuous, ongoing development that is conceived to ensure that our vehicles continue to embody the highest quality and safety standards combined with advanced, state-of-the-art technology. For this reason, it is possible that the features described in this Owner's Manual could differ from those on your vehicle.

For your own safety

Maintenance and repairs



Advanced technology, e.g. the use of modern materials and high-performance electronics, requires specially adapted maintenance and repair methods. Therefore, have corresponding work on your BMW performed only by your BMW Sports Activity Vehicle Center or a workshop that works according to BMW repair procedures with correspondingly trained personnel. If this work is not carried out properly, there is a danger of subsequent damage and related safety hazards. ◀

Parts and accessories

 For your own safety, use genuine parts and accessories approved by BMW.

When you purchase accessories tested and approved by BMW and Genuine BMW Parts, you simultaneously acquire the assurance that they have been thoroughly tested by BMW to ensure optimum performance when installed on your vehicle.

BMW warrants these parts to be free from defects in material and workmanship.

BMW will not accept any liability for damage resulting from installation of parts and accessories not approved by BMW.

BMW cannot test every product made by other manufacturers to verify if it can be used on a BMW safely and without risk to either the vehicle, its operation or its occupants.

Genuine BMW Parts, BMW Accessories and other products approved by BMW, together with professional advice on using these items, are available from all BMW Sports Activity Vehicle Centers.

Installation and operation of non-BMW approved accessories such as alarms, radios, amplifiers, radar detectors, wheels, suspension components, brake dust shields, telephones, including operation of any mobile phone from within the vehicle without using an externally mounted antenna, or transceiver equipment such as CBs, walkie-talkies, ham radios or similar accessories, may cause extensive damage to the vehicle, compromise its safety, interfere with the vehicle's electrical system or affect the validity of the BMW Limited Warranty. Refer to your BMW Sports Activity Vehicle Center for additional information. ◀

 Maintenance, replacement, or repair of the emission control devices and systems may be performed by any automotive repair establishment or individual using any certified automotive part. ◀

California Proposition 65 Warning

California laws require us to issue the following warning:

 Engine exhaust and a wide variety of automobile components and parts, including components found in the interior furnishings in a vehicle, contain or emit chemicals known to the State of California to cause cancer and birth defects and reproductive harm. In addition, certain fluids contained in vehicles and certain products of component wear contain or emit chemicals known to the State of California to cause cancer and birth defects or other reproductive harm.

Battery posts, terminals and related accessories contain lead and lead compounds. Wash your hands after handling.

Used engine oil contains chemicals that have caused cancer in laboratory animals. Always protect your skin by washing thoroughly with soap and water. ◀

Service and warranty

We recommend that you read this publication thoroughly.

Your BMW is covered by the following warranties:

- ▷ New Vehicle Limited Warranty
- ▷ Rust Perforation Limited Warranty
- ▷ Federal Emissions System Defect Warranty
- ▷ Federal Emissions Performance Warranty
- ▷ California Emission Control System Limited Warranty

Detailed information about these warranties is listed in the Service and Warranty Information Booklet for US models or in the Warranty and Service Guide Booklet for Canadian models.

Reporting safety defects

For US customers

The following applies only to vehicles owned and operated in the US.

If you believe that your vehicle has a defect which could cause a crash or could cause injury or death, you should immediately inform the National Highway Traffic Safety Administration, NHTSA, in addition to notifying BMW of North America, LLC, P.O. Box 1227, Westwood, New Jersey 07675-1227, Telephone 1-800-831-1117.

If NHTSA receives similar complaints, it may open an investigation, and if it finds that a safety defect exists in a group of vehicles, it may order a recall and remedy campaign. However, NHTSA cannot become involved in individual problems between you, your dealer, or BMW of North America, LLC.

To contact NHTSA, you may call the Vehicle Safety Hotline toll-free at 1-888-327-4236 (TTY: 1-800-424-9153); go to <http://www.safercar.gov>; or write to: Administrator, NHTSA, 400 Seventh Street, SW., Washington, DC 20590. You can also obtain other information about motor vehicle safety from <http://www.safercar.gov>

For Canadian customers

Canadian customers who wish to report a safety-related defect to Transport Canada, Defect Investigations and Recalls may call 1-800-333-0510 toll-free from anywhere in Canada or 1-613-993-9851 from the Ottawa region and from other countries, or contact Transport Canada by mail at: Transport Canada, ASFAD, Place de Ville, Tower C, 330 Sparks Street, Ottawa, ON, K1A 0N5. You can also obtain other information about motor vehicle safety from <http://www.tc.gc.ca>



A blurred, blue-tinted image of a car, likely a sedan, viewed from a front-quarter perspective. The car is out of focus, with the background also blurred, creating a sense of motion or a shallow depth of field. The overall color palette is monochromatic, consisting of various shades of blue and grey.

At a glance







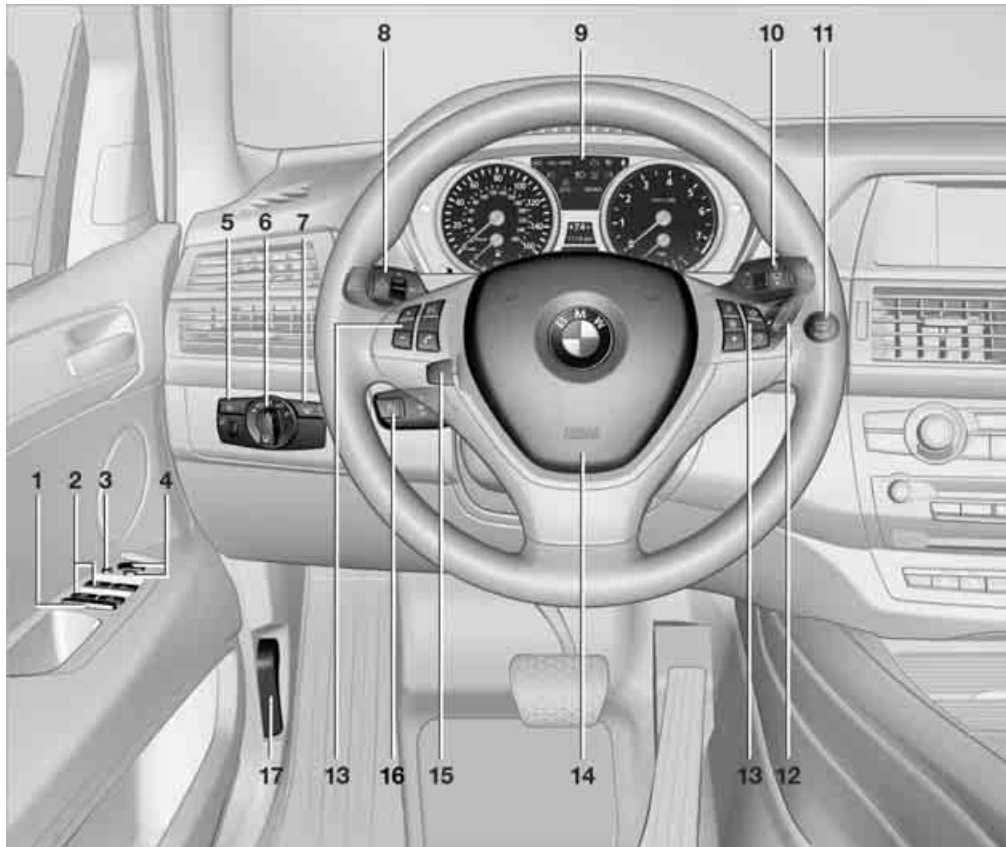









This overview of buttons, switches and displays is intended to familiarize you with your vehicle's operating environment. The section will also assist you in becoming acquainted with the control concepts and options available for operating the various systems.

Cockpit

Around the steering wheel: controls and displays



- 1 Rear window safety switch [39](#)
- 2 Opening and closing windows [38](#)
- 3 Folding exterior mirrors in and out* [51](#)
- 4 Adjusting exterior mirrors [51](#)
Automatic curb monitor* [52](#)

- 5  Instrument lighting 105
 Fog lamps 105
- 6  Parking lamps 102
 Low beams 102
 Automatic headlamp control* 102
 Adaptive Head Light* 104
- 7  Head-Up Display* 99
- 8  Turn signals 66
 High beams, headlamp flasher 66
 Roadside parking lamps* 104
 Time, date, outside temperature, Check Control 71, 79
 Computer 73
- 9 Instrument panel 12
- 10  Windshield wipers 67
 Rain sensor 67
 Rear window wiper 68
- 11  Starting/stopping engine and switching ignition on/off 59
- 12 Ignition lock 59

13 Buttons on steering wheel



Telephone*:

- ▷ Press: accepting and ending call, starting dialing* for selected phone number and redialing if no phone number is selected
- ▷ Press longer: redialing



Volume



Activating/deactivating voice command system* 23



Changing radio station



Selecting music track
 Scrolling in phone book and in lists with stored phone numbers



Individually programmable 53



Individually programmable 53



Steering wheel heating* 53

14 Horn, entire surface

15



Steering wheel adjustment 52

16



Cruise control* 69

17 Releasing hood 241

instrument panel

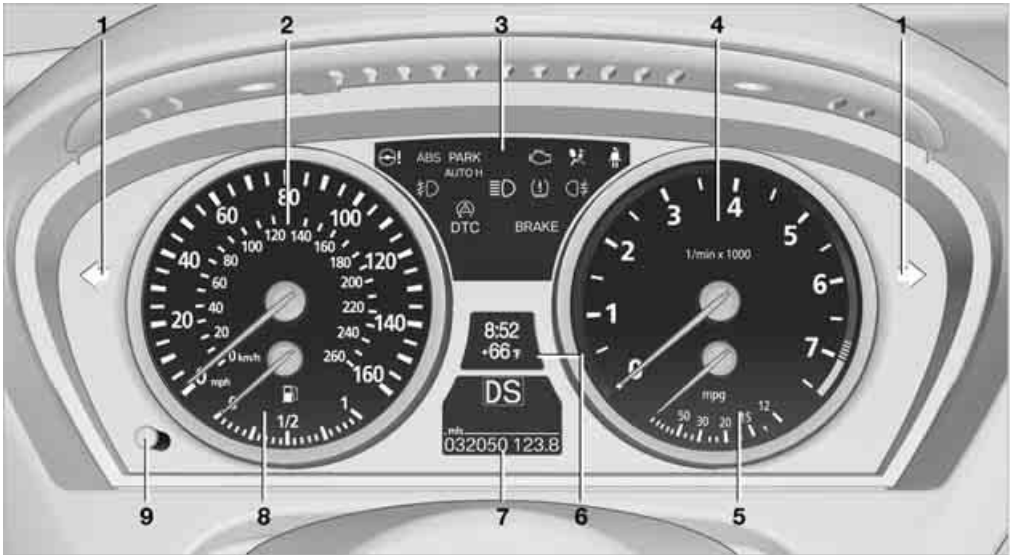

- 1 Indicator lamps for turn signals
- 2 Speedometer
- 3 Indicator and warning lamps [13](#)
- 4 Tachometer [72](#)
- 5 Energy Control [72](#)
- 6 Display for
 - ▷ Clock/date [71](#)
 - ▷ Outside temperature [71](#)
 - ▷ Indicator and warning lamps [78](#)
 - ▷ Speed of cruise control* [69](#)
- 7 Display for
 - ▷ Odometer and trip odometer [71](#)
 - ▷ Computer [73](#)
 - ▷ Date and remaining travel distance for service requirements [75](#)
 - ▷ Automatic transmission positions [64](#)
 - ▷ HDC Hill Descent Control [90](#)
 - ▷ ▲ Check Control message present [78](#)
 - ▷ Adaptive Drive* [91](#)
- 8 Fuel gauge [72](#)
- 9 Resetting trip odometer [71](#)
Displaying service requirement [71](#)

Indicator and warning lamps

The concept



The indicator and warning lamps can light up in different combinations and colors.

Some lamps are tested for proper function by briefly lighting up during starting of the engine or when the ignition is switched on.

Explanatory text messages



Text messages at the bottom edge of the Control Display explain the meaning of the displayed indicator and warning lamps.

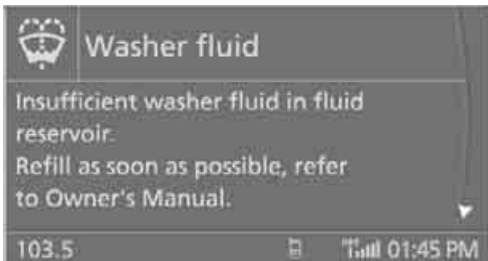





Additional information, e.g. on the cause of a malfunction and on the corresponding need to take action can be displayed via the Check Control, refer to page 78.

In the case of corresponding urgency, this information is displayed immediately when the related lamp lights up.

Indicator lamps without text messages

The following indicator lamps indicate that certain functions are activated:

-  With parking brake set [61](#)
-  With parking brake set for Canadian models
-  Fog lamps [105](#)
-  High beams/headlamp flasher [104](#)
-  Lamp flashes:
DSC or DTC controls the drive and braking forces for maintaining vehicle stability [89](#)

Around the center console: controls and displays

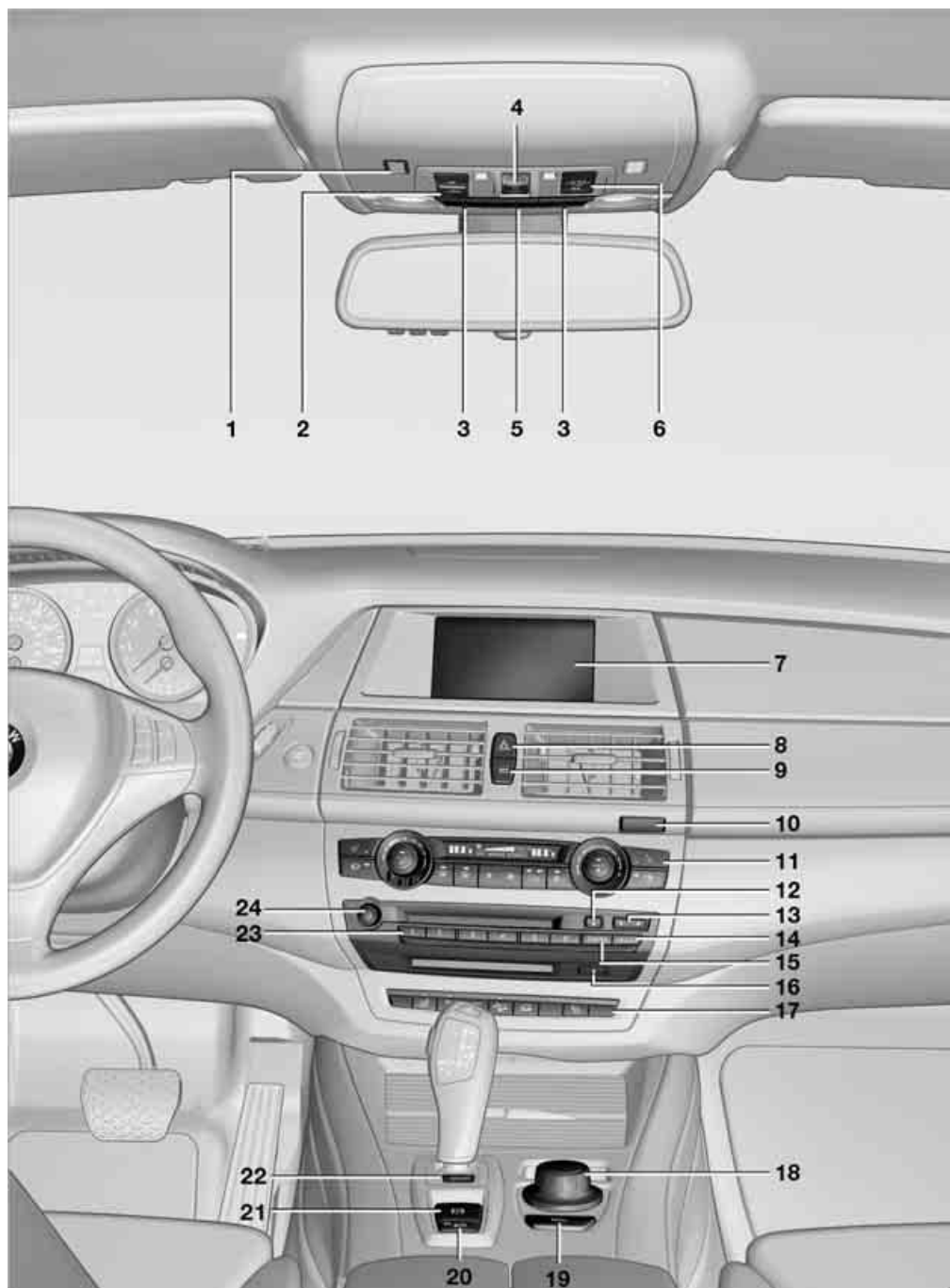

- 1 Microphone for hands-free mode for telephone* and for voice command system* 23
- 2 Initiating an emergency request 255
- 3 Reading lamps 105
- 4 Panorama glass sunroof* 39
- 5 Interior lamps 105
- 6 Passenger airbag status lamp 97
- 7 Control Display 16
Displays for menu navigation
- 8 Hazard warning flashers
- 9 Central locking system 29
- 10 Opening glove compartment 118
- 11 Automatic climate control 107



Manual air distribution 108

AUTO

Automatic air distribution and volume 107



Cooling function 109



AUC Automatic recirculated-air control 109



Maximum cooling 109



Air volume 108
Residual heat utilization 110



Defrosting windows and removing condensation 108



Rear window defroster 108



Seat heating* 50



Active seat ventilation* 50

- 12 Ejecting audio CD
- 13 Changing
 - ▷ radio station 162
 - ▷ track 162
- 14 Selecting radio, CD and CD changer
- 15 Selecting AM or FM waveband

- 16 Ejecting navigation DVD with navigation system* 136

- 17  Opening liftgate 33



Active seat* 51



PDC Park Distance Control* 84
Rear view camera* 86

DTC

DTC Dynamic Traction Control 89



HDC Hill Descent Control 90

- 18 Controller 16
Turn, press or move horizontally in four directions

- 19 Opening start menu on Control Display 17

- 20 Automatic Hold 61

- 21 Parking brake 60

- 22 Adaptive Drive* 91

- 23 Programmable memory/direct selection buttons 21

- 24 Switching Entertainment sound output on/off and adjusting volume 162

iDrive combines the functions of a large number of switches. This allows these functions to be operated from a central position. The following section provides an introduction to basic menu

navigation. The control of the individual functions is described in connection with the relevant equipment.

Controls

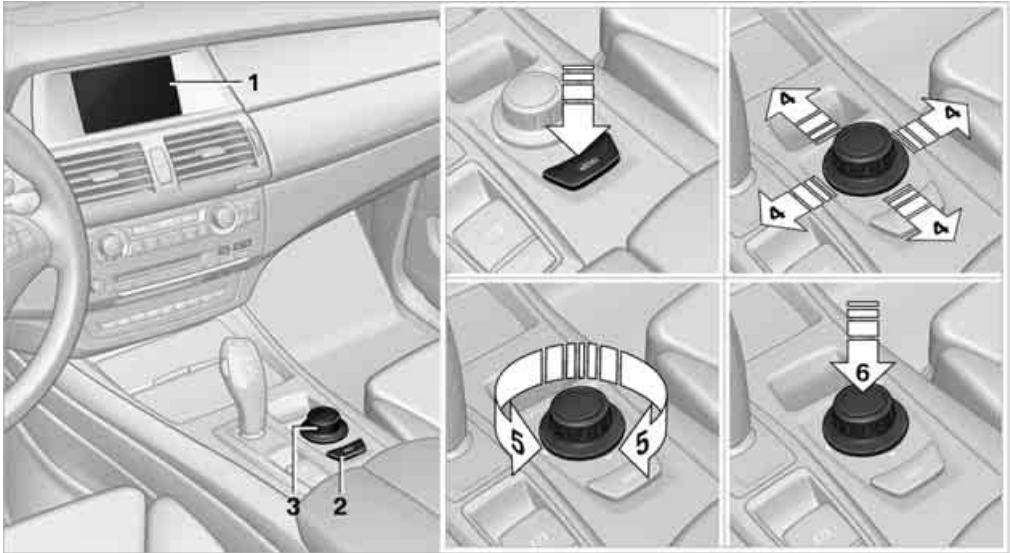

- 1 Control Display
- 2 **MENU** button
Opening start menu
- 3 Controller
With the controller you can select menu items and make settings:
 - ▷ move in four directions, arrows 4
 - ▷ turn, arrow 5
 - ▷ press, arrow 6

⚠ To avoid posing an unnecessary hazard due to inattention, both to your own vehicle's occupants and to other road users: never attempt to use the controls or make entries unless traffic and road conditions allow. ◀

Menu overview

Communication

- ▷ Telephone*
- ▷ BMW Assist* or TeleService*

Navigation or onboard information

- ▷ Navigation system*
- ▷ Onboard information, e.g. for displaying the average fuel consumption

Entertainment

- ▷ Radio
- ▷ CD player and CD changer*
- ▷ External audio device

Climate

- ▷ Vent settings
- ▷ Seat heater distribution*
- ▷ Automatic programs
- ▷ Parked car ventilation*

i menu

- ▷ Switching off Control Display
- ▷ Tone and display settings
- ▷ Settings for traffic information*
- ▷ Settings for your vehicle, e.g. for the central locking system
- ▷ Display of maintenance intervals and dead-lines for legally mandated inspections
- ▷ Settings for telephone*

Operating principle

From radio readiness, refer to page 59, the following message is shown on the Control Display:

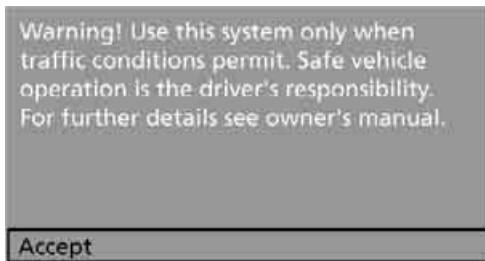

To hide the message:
Press the controller.
This displays the start menu.

On vehicles with a single drive, the message automatically disappears after approx. 10 seconds.

Start menu



You can call up all the functions of iDrive using five menu items.

Opening start menu

Press the **MENU** button.

To open the start menu from the **i** menu:

Press the **MENU** button twice.

Opening menu items of start menu

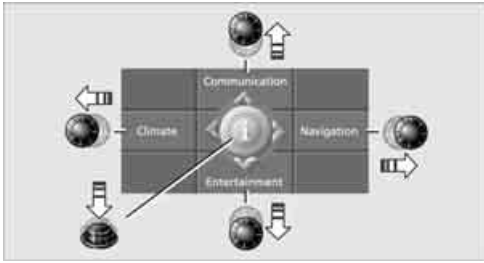

With the start menu you can open the menu items Communication, Navigation, Entertainment and Climate by moving the controller to the left, right, front or rear.

You can open the **i** menu by pressing the controller.

Comfort opening of menu items

Comfort opening offers you:



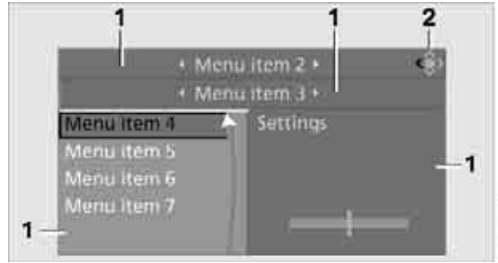

- ▶ Opening of a menu item of the start menu in the last display shown
- ▶ Direct changing between Communication, Navigation, Entertainment and Climate without pressing the **MENU** button

For this purpose, move the controller in the corresponding direction and hold it for longer than approx. 2 seconds.

Displays in menu



- 1 Each menu is divided into fields. The respective active field is highlighted.
- 2 A symbol indicates the last selected menu item of the start menu:

-  Communication
-  Navigation or onboard information
-  Entertainment
-  Climate
-  **i** menu

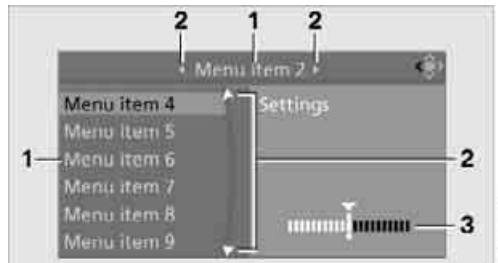

- 1 Menu items are usually grouped in horizontal or vertical lists.
- 2 In these lists, arrows indicate the possibility of accessing other menu items that are not currently visible.
- 3 Settings are displayed graphically or numerically.

Operating principle at a glance

Basic operation via iDrive is described in this view.

You can view the individual steps under Settings on Control Display, Brightness of Control Display, refer to page 82.

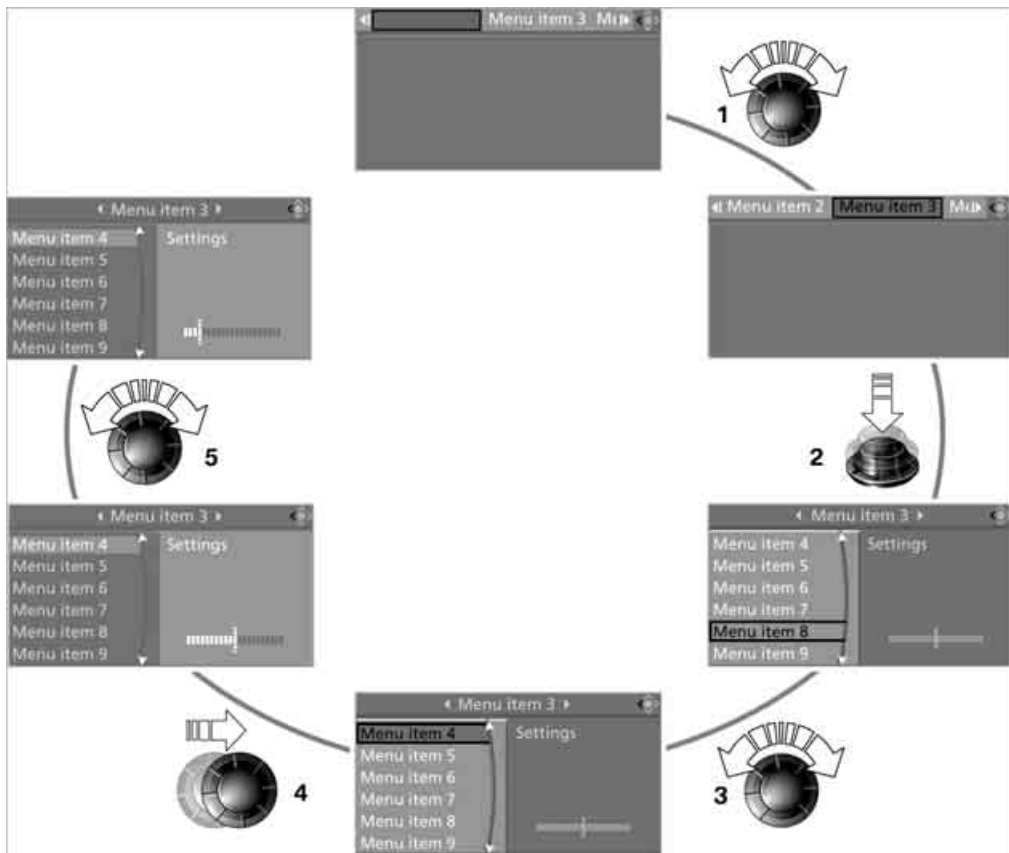

- 1 Selecting menu item:**
 - ▶ Turn the controller; the highlight moves
 - ▶ Menu items shown in white can be selected by highlighting
- 2 Activating menu item:**
 - ▶ Press the controller
 - ▶ New menu items are displayed or the function is carried out
- 3 Selecting menu item: refer to 1**
- 4 Changing between fields:**
 - ▶ Briefly move the controller left, right, forward or back
 - ▶ Release controller
 - ▶ Active field appears lighter
- 5 Adjusting settings:**
 - ▶ Turn controller
 - ▶ Graphic display, numerical value or text displays can be changed
 - ▶ Confirmation by changing field

Status information



- 1 Display for:
 - ▷ Entertainment: Radio, CD
 - ▷ Telephone* in "Communication": Name of linked mobile phone, network search or no network
 - ▷ "BMW Assist"**: Existing voice connection with a service from BMW Assist
- 2 Entertainment sound output off
- 3 Display for traffic information*, TI: Traffic information for the navigation system can be received and transmission is switched on
- 4 Display for:
 - ▷ New entries present in "Missed calls"*
 - ▷ Roaming active
- 5 Telephoning* possible if the mobile phone is logged-on in the vehicle
 Mobile phone network reception strength, display dependent on mobile phone
- 6 Time

Other displays:

The status information is temporarily hidden when there are Check Control instructions or inputs via the voice command system*.

Assistance window*



Additional information can be displayed in the assistance window:

- ▷ The computer or the trip computer
- ▷ The arrow or map view with a navigation system*
- ▷ The current position

Selecting display

1. Move the controller to the right to change to the assistance window and press the controller.

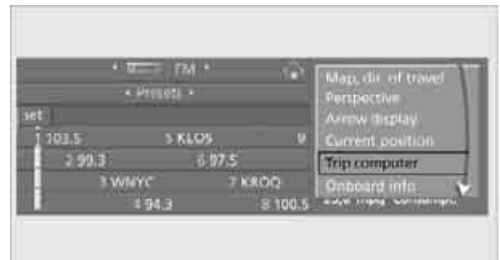

2. Select a menu item.
3. Press the controller.

Switching assistance window off/on

1. Move the controller to the right to change to the assistance window and press the controller.
2. Select "Assist. window off" and press the controller.



To switch on, change to the assistance window and press the controller.

Switching Control Display off/on

1. Press the **MENU** button.
This opens the start menu.
2. Press the controller to open the **i** menu.
3. Select "Display off" and press the controller.



To switch on, press the controller.

Programmable memory/direct selection buttons

You can store and run certain functions of iDrive on the direct selection buttons:

- ▷ Destinations of navigation
- ▷ Telephone, phone numbers*
- ▷ Entertainment:
 - ▷ Radio station
 - ▷ CD
 - ▷ CD compartment of CD changer*
 - ▷ AUX

The assignment of the direct selection buttons is stored for the remote control currently in use.

Saving function

Destinations of navigation

1. Select destination, e.g. in the destination list or the address book.
2. Press the **1** ... **6** button longer than 2 seconds.

Special features:

- ▷ With the destination guidance system and the map view started, the current destination is stored.
- ▷ During destination entry via a map, the coordinates at the cursor are stored, not the current destination.

Telephone, phone numbers

1. Enter the phone number or select it in a list of the stored phone numbers, e.g. of the "A - Z" list.
2. Press the **1** ... **6** button longer than 2 seconds.

If a name is assigned to the phone number, the name will also be stored.

Entertainment

In the Entertainment menu, the sound source currently heard, e.g. a radio station, is stored, regardless of the selection on the Control Display.

1. Select the desired function, e.g. radio station or CD.
2. Press the **1** ... **6** button longer than 2 seconds.

 If the vehicle is equipped with two drives, the current track is stored for CDs with compressed audio files. ◀

Running function

Press the **1** ... **6** button.

The function is run immediately. This means, for example, that when a phone number is selected, the connection is also established, or when a navigation destination is called up, destination guidance is started.

Displaying button assignment





You can display the assignment of the buttons by touching them with your finger. Please do not wear gloves when doing so. Touching with an object, e.g. a pen, does not function.

Displaying short info

Touch the **1** ... **6** button.

The assignment of the buttons is displayed.



-  Destination of navigation system
-  Entertainment source
-  Telephone, phone number
-  Not assigned

Displaying detailed information

Touch and hold the **1** ... **6** button.

Deleting button assignments

1. Press the **MENU** button.
This opens the start menu.
2. Press the controller to open the **i** menu.
3. Select "Settings" and press the controller.
4. Select "Vehicle / Tires" and press the controller.
5. Select "Programmable Memory Keys" and press the controller.

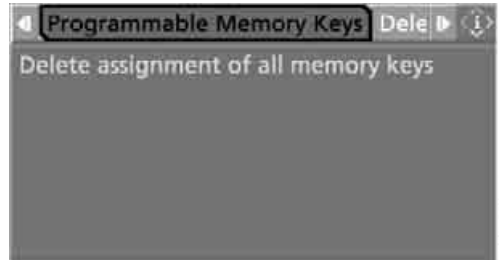

6. Select "Delete assignment of all memory keys" and press the controller.
7. Select "Yes" and press the controller.

Voice command system*

The concept

The voice command system allows you to control operation of various vehicle systems without ever removing your hands from the steering wheel.

Individual menu items on the Control Display can be spoken as commands. This frees you of having to use the controller.

The voice command system transforms your oral commands into control signals for the selected systems and provides support in the form of instructions or questions.

The voice command system uses a special microphone located in the area of the interior rearview mirror, refer to page 14.

Precondition



Via iDrive, set the language that applies for the voice command system in order to enable identification of the spoken commands. To set the language of iDrive, refer to page 83.

Symbols in Owner's Manual

- ›...‹ Say the specified commands word for word.
- ››...‹‹ Indicates responses of the voice command system.

Voice commands

Activating voice command system

1. Press the  button on the steering wheel.
 This symbol on the Control Display and an acoustic signal tell you that the voice command system can respond to commands.





2. Say the command.
The command is displayed on the Control Display.



-  This symbol is shown on the Control Display when you can say additional commands. If no other commands are possible, then operate the equipment via iDrive.

Terminating or canceling voice command system

Press the  button on the steering wheel or

 ›Cancel‹

Commands

Having possible commands read aloud

You can have the system read aloud the possible commands related to the selected menu item on the Control Display.

To have the system list the possible commands:

 ›Options‹

For example, if you have selected "CD", the system will read aloud the possible commands for operating the CD player and the CD changer*.

Opening help

 ›Help‹

Using alternative commands

There are often a number of commands to run a function, e.g.:

 ›Radio on‹ or ›Turn radio on‹



Running functions directly with short commands

With short commands you can carry out certain functions directly, regardless of which menu item is selected, refer to page 265.

Opening start menu

 ›Main menu‹



Example: selecting a track

1. Switch on Entertainment sound output if necessary.
2. Press the  button on the steering wheel.
3.  ›Entertainment‹
The system says:
››Entertainment‹‹



4.  ›CD‹
The system says:
››CD drive switched on‹‹



5. Press the  button on the steering wheel.
6.  6. Select a track, e.g.:
›Track 1‹
The system says:
››Track 1‹‹



Notes

 The mobile phone can also be operated with voice commands, refer to page 219. ◀

For voice commands, bear the following in mind:

- ▷ Say the commands and numbers smoothly and at normal volume, avoiding excessive emphases and pauses. This also applies to spelling when entering the destination.
- ▷ Always issue commands in the language of the voice command system.
- ▷ When selecting a radio station, use the common pronunciation of the station name.
- ▷ For entries in the voice-activated phone book, only use names in the language of the voice command system and no abbreviations.
- ▷ Keep the doors, windows and panorama glass sunroof* closed to prevent interference from ambient noise.
- ▷ Avoid making other noise in the vehicle while speaking.



The background of the page is a blurred, blue-tinted image of a car's interior, showing the dashboard, steering wheel, and center console. The text is overlaid on a white rectangular area on the right side of the page.

Controls

This chapter is intended to provide you with information for complete control of your vehicle. Its extensive array of features and accessories, both for driving and for your own safety, comfort and convenience, are described here.

Opening and closing

Keys/remote control



Each remote control contains a battery which is automatically charged in the ignition lock while driving. Drive a longer distance with each remote control at least twice a year to keep the battery charged. For comfort access*, the remote control contains a replaceable battery, refer to page 38.

Depending on which remote control is detected by the vehicle during unlocking, different settings are called up and carried out in the vehicle, refer to Personal Profile, page 28.

Information on the required maintenance is also stored in the remote control, refer to Service data in remote control, page 245.

Integrated key



Press button 1 to unlock the key.

The integrated key fits the following locks:

- ▷ Driver's door, refer to page 31
- ▷ Floor panel flap in cargo bay, refer to page 123

New remote controls

To obtain additional or replace lost keys, new remote controls with an integrated key are available at your BMW Sports Activity Vehicle Center.

Personal Profile

The concept

You can set a number of functions of your BMW individually according to your preferences. Personal Profile ensures that most of these settings are stored for the remote control currently in use without you having to do anything. When the vehicle is unlocked, the corresponding remote control is detected and the settings stored for it are called up and carried out.

This means that you will always find your BMW set to your own personal settings even if another person with his/her own remote control and settings has used the vehicle since the last time you drove it. The individual settings are stored for a maximum of three remote controls.

Personal Profile settings

Details on the settings are provided on the specified pages.

- ▷ When unlocking with the remote control, either unlock only the driver's door or the entire vehicle, refer to page 30
- ▷ Locking the vehicle after a short time or after starting off, refer to page 32
- ▷ Assigning the programmable buttons on the steering wheel, refer to page 53

- ▷ Settings for the display on the Control Display:
 - ▷ Brightness of the Control Display, refer to page [82](#)
 - ▷ Measuring units for consumption, route/distances, temperature, and pressure, refer to page [82](#)
 - ▷ Language on Control Display, refer to page [83](#)
 - ▷ 12h/24h mode of the clock, refer to page [82](#)
 - ▷ Date format, refer to page [82](#)
- ▷ Showing optical warning for PDC Park Distance Control*, refer to page [85](#)
- ▷ Selection, brightness and position of display in Head-Up Display*, refer to page [99](#)
- ▷ Settings of automatic climate control, refer to page [107](#)
- ▷ Positions of driver's seat, exterior mirrors, and steering wheel*, refer to page [44](#)
- ▷ With Adaptive Drive*, last selected chassis and suspension tuning setting, refer to page [91](#)
- ▷ Audio sources, volume and tone settings, refer to page [163](#)
- ▷ Radio, displaying stored stations, refer to page [166](#)
- ▷ Telephone, setting volume, refer to pages [214](#), [220](#)
- ▷ Pathway lighting, refer to page [103](#), and daytime running lamps*, refer to page [103](#)
- ▷ Triple turn signal activation, refer to page [67](#)
- ▷ With rear view camera*, selection of functions, refer to page [86](#), and type of display, refer to page [88](#)
- ▷ With programmable memory/direct selection buttons, selection of stored functions, refer to page [21](#)

Central locking system

The concept

The central locking system is ready for operation whenever the driver's door is closed.

The system simultaneously engages and releases the locks on the following:

- ▷ Doors
- ▷ Liftgate
- ▷ Fuel filler door

Operating from outside

- ▷ via the remote control
- ▷ via the door lock
- ▷ with comfort access* via the door handles

At the same time, the anti-theft system is also operated. It prevents the doors from being unlocked using the lock buttons or door handles. The interior lamps and the courtesy lamps* are also switched on and off with the remote control. The alarm system is armed/disarmed at the same time.

You can find more detailed information on the alarm system on page [35](#).

Operating from inside

Via the button for central locking, refer to page [32](#). The fuel filler door is not locked.

In an accident of sufficient severity, the central locking system automatically unlocks the vehicle. In addition, the hazard warning flashers and interior lamps come on.

Opening and closing: Using remote control



Persons or animals left unattended in a parked vehicle can lock the doors from the inside. Always take along the remote control when leaving the vehicle so that the vehicle can then be opened from the outside. ◀

Unlocking

Press the  button.



This unlocks the vehicle.

You can set how the vehicle is unlocked. The setting is stored for the remote control currently in use.

iDrive, for operating principle refer to page 16.

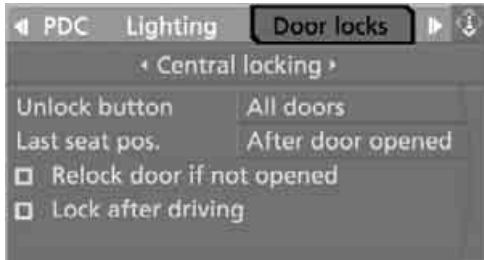
1. Press the **MENU** button.
This opens the start menu.
2. Press the controller to open the **i** menu.
3. Select "Settings" and press the controller.
4. Select "Vehicle / Tires" and press the controller.
5. Change to upper field if necessary. Turn the controller until "Door locks" is selected and press the controller.



6. Select "Central locking" and press the controller.
7. Select "Unlock button" and press the controller.
8. Select a menu item:
 - ▷ "All doors"
Press the  button once to unlock the entire vehicle.
 - ▷ "Driver's door only"
Press the  button once to unlock only the driver's door and the fuel filler door. Press the button twice to unlock the entire vehicle.



9. Press the controller.

Comfort opening

Press and hold the  button. The windows and the panorama glass sunroof* are opened.

Locking

Press the  LOCK button.

 Do not lock the vehicle from the outside if persons are inside, as unlocking from the inside is not possible without special knowledge. ◀

Switching on interior lamps

With vehicle locked:

Press the  LOCK button.

You can also use this function to locate your vehicle in parking garages etc.

Panic mode*

You can also trigger the alarm system in case of danger:

Press the  button for at least 3 seconds.

Switch off alarm: press any button.

Unlocking liftgate

Press the  button for approx. 1 second.

The liftgate will open slightly, regardless of whether it was previously locked or unlocked.

 During opening, the liftgate pivots back and up. Ensure that adequate clearance is available before opening.

To prevent accidentally locking yourself out, never lay the remote control in the cargo bay. A previously locked liftgate is also locked again after closing. ◀

 If pointed or sharp-edged objects could strike the rear window while driving, be sure to provide protection around all edges. Failure to do so could result in damage to the heating conductors of the rear window. ◀

Setting confirmation signals

You can activate or deactivate the confirmation signals.

1. Press the **MENU** button.
This opens the start menu.
2. Press the controller to open the **i** menu.
3. Select "Settings" and press the controller.
4. Select "Vehicle / Tires" and press the controller.
5. Change to upper field if necessary. Turn the controller until "Door locks" is selected and press the controller.
6. Select "Confirmation" and press the controller.



7. Select the desired signal.
8. Press the controller.
 The signal is activated.

Malfunctions

The remote control may malfunction due to local radio waves. Should the remote control fail to operate due to interference of this kind, unlock and lock the vehicle via the door lock using a key.

If it is no longer possible to lock the vehicle using the remote control, then the battery is discharged. Use this remote control during an extended drive; this will recharge the battery, refer to page 28.

For US owners only

The transmitter and receiver units comply with part 15 of the FCC/Federal Communication Commission regulations. Operation is governed by the following:

FCC ID:
LX8766S
LX8766E
LX8CAS
LX8CAS2

Compliance statement:

This device complies with part 15 of the FCC Rules. Operation is subject to the following two conditions:

- ▶ This device must not cause harmful interference, and
- ▶ this device must accept any interference received, including interference that may cause undesired operation.

 Any unauthorized modifications or changes to these devices could void the user's authority to operate this equipment. ◀

Opening and closing: Using door lock

 Do not lock the vehicle from the outside if persons are inside, as unlocking from the inside is not possible without special knowledge. ◀

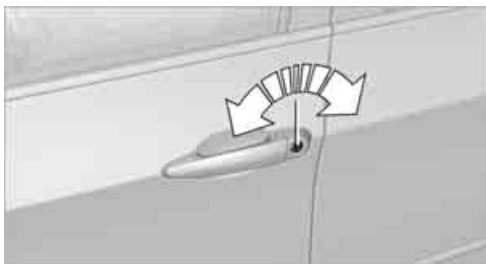

When unlocking

1. Turning the key once unlocks the driver's door and the fuel filler door.
2. Turning the key a second time unlocks the remaining doors and the liftgate.

Convenient operation

You also operate the windows and the panorama glass sunroof* from the driver's door lock.

Turn and hold the key in the positions for unlocking or locking.

⚠ Watch during the closing process to be sure that no one is injured. Rotating the key back into the initial position stops the movement. ◀

Manual operation

In the event of an electrical malfunction, you can turn a key all the way to the right or left in the door lock to lock or unlock the driver's door.

Opening and closing: From inside



This button serves to unlock or lock doors and the liftgate, with the front doors closed. It does not activate the anti-theft system. The fuel filler door remains unlocked.

You can also set the situations in which the vehicle is locked.

iDrive, for operating principle refer to page 16.

1. Press the **MENU** button.
This opens the start menu.
2. Press the controller to open the **i** menu.
3. Select "Settings" and press the controller.
4. Select "Vehicle / Tires" and press the controller.
5. Change to upper field if necessary. Turn the controller until "Door locks" is selected and press the controller.

6. Select "Central locking" and press the controller.



7. Select a menu item:
 - ▷ "Relock door if not opened"
The central locking system automatically locks the vehicle after a short time when no door has been opened.
 - ▷ "Lock after driving"
The central locking system automatically locks the vehicle as soon as you start to drive.

8. Press the controller.

✓ The setting is selected.

The setting is stored for the remote control currently in use.

Unlocking and opening doors

- ▷ Either unlock the doors together with the button for the central locking system and then pull the door handle above the armrest or
- ▷ pull on the door handle of each door twice: the first time unlocks the door, the second time opens it.

Locking

- ▷ Use the central locking button to lock all of the doors simultaneously, or
- ▷ press down the lock button of a door.
To prevent you from being locked out, the open driver's door cannot be locked using the lock button.

⚠ Persons or animals left unattended in a parked vehicle can lock the doors from the inside. Always take along the remote control

when leaving the vehicle so that the vehicle can then be opened from the outside. ◀

Doors

Automatic soft closing*

To close the doors, merely push them gently. The closing process will then be carried out automatically.

 Make sure that the closing path of the doors is clear; otherwise injuries may result. ◀

Liftgate

 During opening, the liftgate pivots back and up. Ensure that adequate clearance is available before opening. ◀

Opening from inside



Press the button: the liftgate opens somewhat unless it has been locked.

Opening from outside



Press the button on the liftgate or the  button on the remote control for approx. 1 second:

The liftgate opens somewhat. It can be swung upward.

Opening manually

In case of an electrical malfunction:

1. From the cargo bay, press out the handle in the liftgate, refer to arrow, with a screwdriver and pull. The liftgate is unlocked.

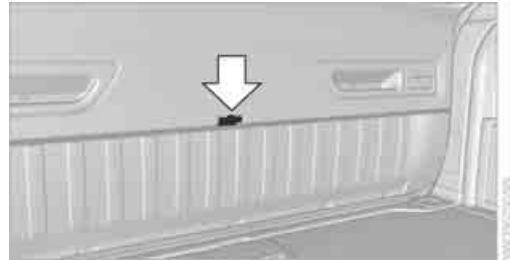

2. Open the liftgate and press in the handle. The liftgate is locked again as soon as it is closed.

Closing

 Make sure that the closing path of the liftgate is clear, otherwise injuries may result. ◀



The handle recesses on the interior trim of the liftgate make it easier to pull down.

 If pointed or sharp-edged objects could strike the rear window while driving, be sure to provide protection around all edges. Failure to do so could result in damage to the heating conductors of the rear window. ◀

Automatic liftgate operation*

Adjusting opening height

You can adjust how far the liftgate is to open. iDrive, for operating principle refer to page 16.

1. Press the **MENU** button.
This opens the start menu.
2. Press the controller to open the **i** menu.
3. Select "Settings" and press the controller.
4. Select "Vehicle / Tires" and press the controller.
5. Change to upper field if necessary. Turn the controller until "Door locks" is selected and press the controller.
6. Select "Tailgate" and press the controller.



7. Turn the controller. The adjustment is applied; the field can be changed.

Opening liftgate

The liftgate opens automatically when you:

- ▷ Press the button on the outside of the liftgate when the vehicle is unlocked.



- ▷ Press the button in the center console.

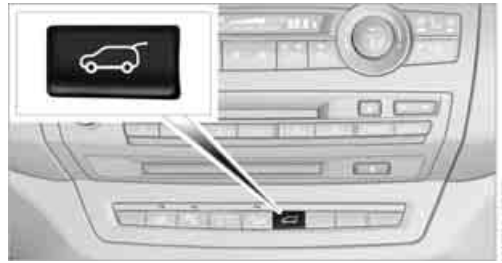

- ▷ Press and hold the button on the remote control.

To stop the opening process:

- ▷ Press the button on the outside of the liftgate.
- ▷ Press and hold the button on the remote control.
- ▷ Press the button on the inside of the liftgate.
- ▷ Press the button on the center console again.

- ▷ The opening process is interrupted if you set the vehicle in motion. ◀

Closing liftgate

- ⚠ Make sure that the closing path of the liftgate is clear, otherwise injuries may result. ◀

Function requirement:
The tailgate is closed.



The liftgate closes automatically when you press the button on the inside of the liftgate.

To stop the closing process:

- ▷ Press the button on the inside of the liftgate.

- ▷ Press the button on the outside of the liftgate.

 Closing is not canceled when you put the vehicle into motion. ◀

Tailgate

Opening

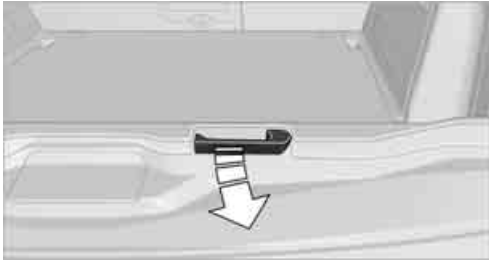

Pull the lever and swing the tailgate downward.

 The open tailgate can be loaded with up to 550 lbs./250 kg. ◀

Closing

Fold the tailgate up and press closed.

Alarm system

The concept

The vehicle alarm system responds:

- ▷ When a door, the hood or the liftgate is opened
- ▷ To movements in the vehicle: interior motion sensor, refer to page 36
- ▷ To changes in the vehicle's tilt if someone attempts to steal the wheels or tow the vehicle
- ▷ To interruptions in battery voltage

Unauthorized operations are briefly signaled by the alarm system:

- ▷ with an acoustic alarm
- ▷ by switching on the hazard warning flashers
- ▷ by flashing the high beams

Arming and disarming alarm system

When you lock or unlock the vehicle, either with the remote control or at the door lock, the alarm system is armed or disarmed at the same time.

The liftgate can also be opened with the system armed with the  button on the remote control, refer to page 30. When the liftgate is closed, it is locked and monitored again.

Switching off alarm

- ▷ Unlock the vehicle using the remote control, refer to page 30.
- ▷ Insert the remote control all the way into the ignition lock.

Indicator lamp displays



- ▷ The indicator lamp under the interior rearview mirror flashes continuously: the system is armed.
- ▷ The indicator lamp flashes after locking: the doors, hood or liftgate are not properly closed. Even if you do not close the alerted area, the system begins to monitor the remaining areas, and the indicator lamp flashes continuously after approx. 10 seconds. However, the interior motion sensor is not activated.
- ▷ The indicator lamp goes out after unlocking: your vehicle has not been disturbed while you were away.
- ▷ The indicator lamp flashes after unlocking until the remote control is inserted into the ignition lock, however for a maximum of approx. 5 minutes: your vehicle has been disturbed while you were away.

Tilt alarm sensor

The tilt of the vehicle is monitored. The alarm system reacts, e.g. in case of an attempted wheel theft or towing.

Interior motion sensor

In order for the interior motion sensor to function properly, the windows and panorama glass sunroof* must be completely closed.

Avoiding unintentional alarms

The tilt alarm sensor and interior motion sensor may be switched off at the same time. This prevents unintentional alarms, e.g. in the following situations:

- ▷ In stacking garages
- ▷ When transporting on car-carrying trains, by sea or on a trailer
- ▷ When animals are to remain in the vehicle

Switching off tilt alarm sensor and interior motion sensor

Press the  LOCK button on the remote control again as soon as the vehicle is locked.

The indicator lamp lights up briefly and then flashes continuously. The tilt alarm sensor and the interior motion sensor are switched off until the next time the vehicle is unlocked and subsequently locked again.

Comfort access*

Comfort access enables you to access your vehicle without having to hold the remote control in your hand. It is sufficient to carry the remote control with you, e.g. in your jacket pocket. The vehicle automatically detects the related remote control in the immediate vicinity or in the interior.

Comfort access supports the following functions:

- ▷ Unlocking/locking vehicle
- ▷ Comfort closing
- ▷ Opening liftgate

- ▷ Starting engine

Functional requirements

- ▷ The vehicle can only be unlocked if the vehicle detects that the remote control carried is not located in the vehicle interior.
- ▷ The next unlocking and locking cycle is not possible until after approx. 2 seconds.
- ▷ The engine can only be started if the vehicle detects that the remote control is located in the vehicle.

Comparison with ordinary remote control

You can control the functions mentioned previously with the comfort access or by pressing the buttons on the remote control. Therefore, please familiarize yourself with the information on opening and closing beginning on page 28 beforehand.

The special features when using comfort access are described in the following.

- ▷ Should a short delay occur when opening or closing the windows or the panorama glass sunroof*, the system is checking whether a remote control is located in the vehicle. Please repeat opening or closing if necessary. ◀

Unlocking

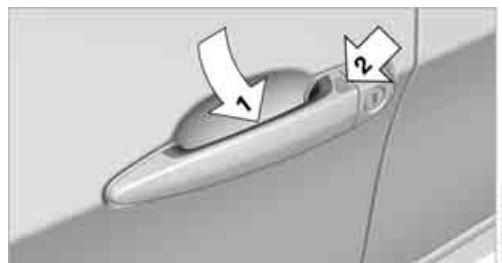

Completely grasp a door handle, arrow 1. This corresponds to pressing the  button.

Locking

Touch the area highlighted in the picture, arrow 2, with your finger for approx. 1 second. This corresponds to pressing the  LOCK button.

 Please make sure that all electronic systems/consumers are switched off before locking to save the battery. ◀

Comfort closing

Hold a finger or the back of a hand on the surface, arrow 2.

The windows and the panorama glass sunroof* are closed.

 Watch during the closing process to be sure that no one is injured. Removing the hand from the door handle immediately stops the closing process. ◀

Opening liftgate

Press the button on the liftgate. This corresponds to pressing the  button.

 If a remote control accidentally left in the cargo bay is detected in the locked vehicle after closing the liftgate, the liftgate opens again. The hazard warning flashers flash and a signal* sounds. ◀

Switching on radio readiness

By briefly pressing the Start/Stop button, you switch on the radio readiness, refer to page 59.

 When doing so, do not depress the brake pedal, otherwise the engine will start. ◀

Starting engine

You can start the engine or switch on the ignition if a remote control is located in the interior of the vehicle. It need not be inserted in the ignition lock, refer to page 59.

As long as no remote control is detected in the vehicle, it is only possible to restart the engine within approx. 10 seconds after it is switched off if no door has been opened.

Switching off engine

▷ Remote control not in ignition lock:
After switching off the engine, the transmission is automatically switched into transmission position P.

▷ Remote control in ignition lock:
If transmission position N is engaged, the transmission remains in this position after the engine is switched off.

Before driving into a car wash

The vehicle can roll if you proceed according to the following steps:

1. Insert remote control into ignition lock.
2. Depress brake pedal.
3. Engage transmission position N.
4. Release the parking brake.
5. Switch off the engine.
6. Leave the remote control in the ignition lock.

Malfunction

The comfort access function may malfunction due to local radio waves. Then open or close the vehicle with the buttons on the remote control or with a key. To start the engine following this, insert the remote control in the ignition lock.



The warning lamp in the instrument panel lights up when an attempt is made to start the engine: starting the engine is not possible. The remote control is not in the vehicle or has a malfunction. Take along the remote control into the vehicle or have it checked. Insert another remote control into the ignition lock if necessary.



The warning lamp in the instrument panel lights up when the engine is running: the remote control is no longer in the vehicle. After switching off the engine, the engine can only be started again within approx. 10 seconds if no door has been opened.



The indicator lamp in the instrument panel lights up and a message appears on the Control Display:
Replace the battery of the remote control.

Replacing battery

The remote control for comfort access contains a battery which must be replaced if necessary.

1. Remove integrated key from remote control, refer to page 28.
2. Remove cover.



3. Lay in new battery with positive side facing upward.
4. Press cover closed.

 Dispose of used batteries at a collection point or at your BMW Sports Activity Vehicle Center. ◀

Windows

 To prevent injuries, exercise care when closing the windows and keep them in your field of vision until they are shut. Always take along the remote control when you leave the vehicle, otherwise children could, for example, operate the windows and injure themselves. ◀

Opening, closing

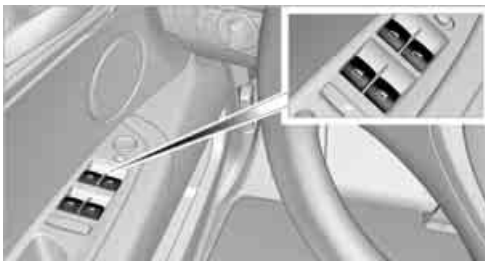

- ▷ Press switch to resistance point: The window continues to open as long as you keep the switch pressed.

- ▷ Press switch beyond resistance point: The window opens automatically. Pressing the switch again stops the opening movement.

You can close the windows in the same manner by pulling the switch.

Separate switches for the rear windows are located in the rear.

For information on using convenient operation at the door lock or with the remote control, refer to page 30 or 32.

For information on comfort closing with comfort access, refer to page 37.

After switching off ignition

You can still operate the windows with the remote control removed or the ignition switched off for approx. 1 minute, as long as neither of the front doors has been opened.

Pinch protection system

If the closing force rises beyond a predefined threshold during closing, the system will stop moving the window prior to lowering it again slightly.

 Despite the pinch protection system, inspect the window's travel path prior to closing it, as the safety system might fail to detect certain kinds of obstructions, such as thin objects, and the window would continue closing.

Do not install any accessories in the range of movement of the windows, otherwise the pinch protection system will be impaired. ◀

Closing without pinch protection system

In case of danger from outside or if, for example, ice on the window prevents normal closing, proceed as follows:

1. Pull the switch beyond the resistance point and hold. The pinch protection system is limited and the window opens slightly if the closing force exceeds a certain value.
2. Pull the switch beyond the resistance point and hold again within approx. 4 seconds.

The window closes without the pinch protection system.

Safety switch

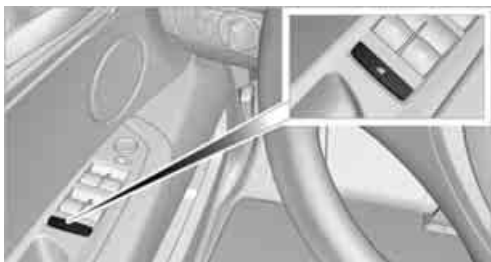

With the safety switch, you can prevent the rear windows from being opened or closed via the switches in the rear passenger area, by children, for example. The LED lights up when this safety feature is activated.

 Always press the safety switch when children ride in the rear, otherwise uncontrolled closing of the windows could lead to injuries. ◀

Panorama glass sunroof*

The panorama glass sunroof is ready for operation with the ignition switched on, refer to page 59.

 To prevent injuries, exercise care when closing the panorama glass sunroof and keep it in your field of vision until it is closed. Always take along the remote control when you leave the vehicle, otherwise children could, for example, operate the roof and injure themselves. ◀

Raising, opening, closing



Raising

Press the switch.

The closed sunroof is raised and the sliding visor opens slightly.

 Do not use force to close the sliding visor with the glass sunroof in its raised position, otherwise the mechanism will be damaged. ◀

Opening, closing

Sliding visor

You can move the sliding visor independently with the sunroof closed or raised.

- ▷ Slide the switch back to the resistance point.
The sliding visor opens as long as you keep the switch in this position.
- ▷ Briefly press the switch back beyond the resistance point.
The sliding visor will open automatically. Briefly pressing the switch stops the motion.

You can close the sliding visor in a similar manner by sliding the switch forwards.

Panorama glass sunroof

With the sliding visor open, proceed as described under Sliding visor.

For information on using convenient operation at the door lock or with the remote control, refer to page 30 or 32.

For information on comfort closing with comfort access, refer to page 37.

Opening and closing sunroof and sliding visor together

Briefly press the switch beyond the resistance point twice consecutively.
Briefly pressing the switch stops the motion.

Comfort mode

- ▷ Press the switch twice with the sunroof open:
The sunroof is raised.

- ▷ When the sunroof is raised, briefly press the switch twice in the opening direction:
The sunroof is opened all the way.

Comfort position

In the comfort position, the sunroof is not completely open; this reduces wind noise in the passenger compartment.

Each time the panorama glass sunroof is completely opened or closed, it stops in the comfort position. If desired, continue the motion following this with the switch.

After switching off ignition

You can still operate the roof for approx. 1 minute, as long as no door has been opened.

Pinch protection system

If the panorama glass sunroof or sliding visor encounter resistance when closing from roughly one third of the sunroof opening or when closing from the raised position, the closing action is interrupted and the panorama glass sunroof and sliding visor reopen a little.

 Despite the pinch protection system, inspect the sunroof's travel path prior to closing it, as the safety system might fail to detect certain kinds of obstructions, such as very thin objects, and the sunroof would continue closing. ◀

Closing without pinch protection system

In case of danger from outside, slide the switch forward beyond the resistance point and hold. The roof closes without the pinch protection system.

Following interruptions in electrical power supply

After a power loss, the sunroof may only respond to the raise command. Then have the system initialized. BMW recommends having this work carried out by your BMW Sports Activity Vehicle Center.

Moving manually*

In the event of an electrical malfunction, you can move the sunroof manually:

1. Remove trim piece. To do so, gently lift the corner of the trim piece with a screwdriver.



2. Using the screwdriver, press in the clamps one after the other, arrows **1**, tilt the cover panel down, arrow **2**, and remove.

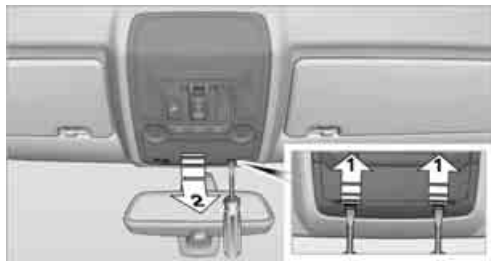

3. Disconnect the motor plug. This significantly reduces the effort required for the manual movement.



4. Take the Allen wrench* from its bracket in the onboard tool kit, refer to page 247, and insert it into the opening provided. Move the panorama glass sunroof in the desired direction.



5. Reconnect the plug.
6. Clip the trim piece into the cover panel, arrow 1. Then fold the cover panel forward until it audibly clicks into place, arrow 2.

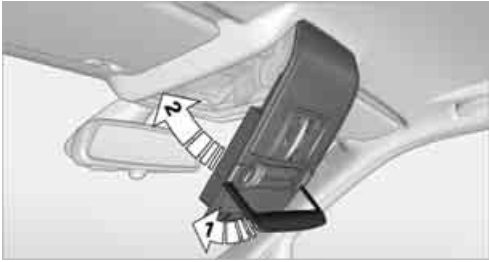

Adjusting

Sitting safely

The ideal sitting position can make a vital contribution to relaxed, fatigue-free driving. In the interaction with the safety belts, the head restraints and the airbags, the seat position plays an important role in an accident. To ensure that the safety systems operate with optimal efficiency, we strongly urge you to observe the instructions contained in the following section.

For additional information on transporting children safely, refer to page 55.

Airbags

 Always maintain an adequate distance between yourself and the airbags. Always hold the steering wheel by its rim with hands at the 9 o'clock and 3 o'clock positions, to minimize the risk of injuries to your hands and arms in the event of airbag deployment.

No one and nothing is to come between the airbags and the seat occupant.

Do not use the cover of the front airbag on the front passenger side as a storage area. Make sure that the front passenger is sitting correctly and does not rest feet or legs on the instrument panel, otherwise leg injuries can occur if the front airbag is triggered.

Make sure that occupants do not rest their head on the side or head airbag, otherwise injuries can occur if the airbags are triggered. ◀

Even if you adhere to all the instructions, injuries resulting from contact with airbags cannot be fully excluded, depending on the circumstances. The ignition and inflation noise may provoke a mild hearing loss in extremely sensitive individuals. This effect is usually only temporary.

For airbag locations and additional information on airbags, refer to page 97.

Head restraint

A correctly adjusted head restraint reduces the risk of spinal injury in the event of an accident.

 Adjust the head restraint so that its center is approx. at ear level. Otherwise there is increased danger of injury in the event of an accident. ◀

Push the head restraints of the 3rd row seats* into the top position.

Head restraints, refer to page 46.

Safety belts

Before every drive, make sure that safety belts are being worn at all of the occupied seats. Airbags complement the safety belt as an additional safety device, but they do not represent a substitute.

Depending on its equipment, your vehicle has either five or seven seats, which are all provided with a safety belt.

 Never allow more than one person to wear a single safety belt. Never allow infants or small children to ride in a passenger's lap. Make sure that the belt lies low around the hips in the lap area and does not press on the abdomen. The safety belt may not lie across the neck, rub on sharp edges, be routed over solid or breakable objects or be pinched. Wear the safety belt without twisting, snugly across the lap and shoulders, as close to the body as possible. Otherwise the belt can slip over the hips in the lap area in a frontal impact and injure the abdomen. Avoid wearing clothing that prevents the belt from fitting properly and pull the belt in the upper body area periodically to readjust the tension, in order to avoid a reduction in the restraint of the safety belt.

If the center safety belt in the rear is used, the larger backrest half must be locked, refer to page 123, otherwise the center safety belt has no restraining action. ◀

Safety belts, refer to page 48.

Seats

Note before adjusting

⚠ Never attempt to adjust or calibrate your seat while the vehicle is moving. The seat could respond with unexpected movement, and the ensuing loss of vehicle control could lead to an accident.

Never adjust manually adjustable seats while the vehicle is moving, as otherwise the restraining effect of these seats during accidents could be reduced.

Also on the passenger side, do not incline the backrest too far to the rear while the vehicle is being driven, otherwise there is a danger in the event of an accident of sliding under the safety belt, eliminating the protection normally provided by the belt. ◀

Also observe the information on damage to safety belts on page 49 and on the height of the head restraints on page 46.

Adjusting manually*

⚠ To ensure that the safety systems continue to provide optimized protection, please observe the adjustment instructions on page 42. ◀

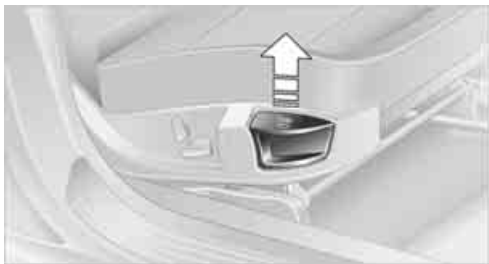

Pull the lever and slide the seat to the desired position. After you release the lever, move the seat forward or backward slightly so that it engages fully.

Thigh support*



Pull the lever and adjust the thigh support in the longitudinal direction.

Adjusting electrically

⚠ To ensure that the safety systems continue to provide optimized protection, please observe the adjustment instructions on page 42. ◀

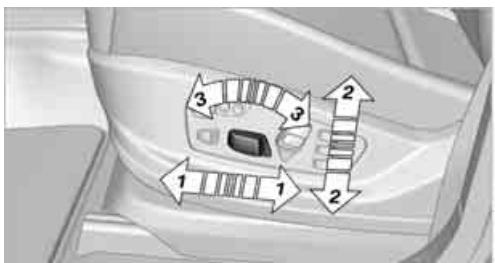

- 1 Longitudinal direction
- 2 Height
- 3 Seat tilt



- 4 Backrest

Differs depending on seat:

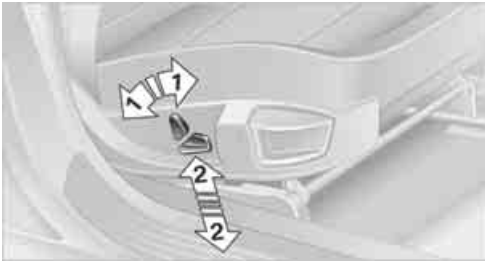

- 1 Backrest
- 2 Height

Additional depending on seat:

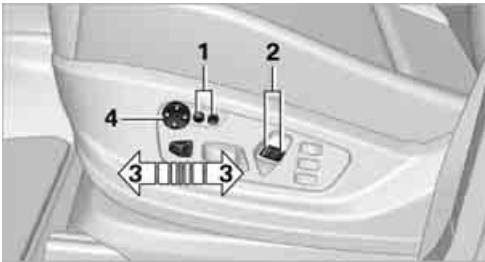

- 1 Backrest width*
- 2 Shoulder support*
- 3 Thigh support*
- 4 Lumbar support*

Backrest width*

The width of the backrest can be changed with the side wings to adjust the side support to your own needs.

Shoulder support*

This also supports the back in the shoulder area, provides a relaxed sitting position and helps relieve stress on the shoulder muscles.

The shoulder support is also used to adjust the distance of the head restraint from the back of the seat occupant's head.

Lumbar support*



You can also adjust the contour of the backrest to obtain additional support in the lumbar region.

The upper hips and spinal column receive supplementary support to help you maintain a relaxed, upright sitting position.

- ▷ Increase or decrease curvature: press front or rear section of switch.
- ▷ Shift curvature up or down: press upper or lower section of switch.

Seat, mirror and steering wheel memory*

You can store and request two different positions for the driver's seat and passenger seat*, exterior rearview mirrors, and steering wheel.

The adjustment of the backrest width and lumbar support is not stored in the memory.

Storing

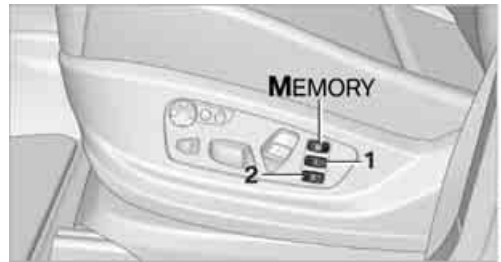

1. Switch on radio readiness or ignition, refer to page 59.
2. Set the desired seat, exterior mirror and steering wheel positions.

- Press the **M** button:
The LED in the button lights up.
- Press the desired memory button **1** or **2**:
The LED goes out.
The positions of the driver's seat, the exterior rearview mirrors, and steering wheel are stored for the remote control currently in use.

Calling up automatically

You can choose when the stored positions of the driver's seat, exterior rearview mirrors, and steering wheel are activated.

- Calling up when unlocking vehicle
- Calling up when opening driver's door

! When using this feature, always make sure that the footwell behind the driver's seat is empty and unobstructed. Failure to do so could cause injury to persons or damage to objects behind the seat as a result of a rearward movement of the seat. ◀

The system cancels the adjustment procedure when you briefly press one of the seat adjustment switches or one of the memory buttons.

Selecting calling up automatically

iDrive, for operating principle refer to page 16.

- Open the start menu.
- Press the controller to open the **i** menu.
- Select "Settings" and press the controller.
- Select "Vehicle / Tires" and press the controller.
- Change to upper field if necessary. Turn the controller until "Door locks" is selected and press the controller.

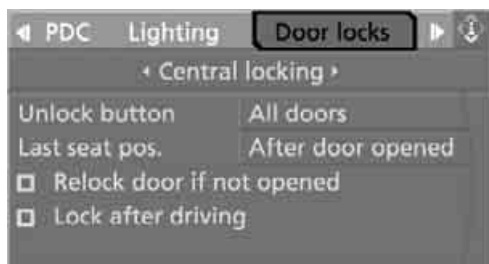

- Select "Central locking" and press the controller.
- Select "Last seat pos." and press the controller.
- Select "After unlocking" or "After door opened".



- Press the controller.

Deactivating calling up automatically

Select "Deactivated" and press the controller.

Calling up manually

! Do not call up a position from the memory while the vehicle is moving. There is a risk of accident from unexpected movement of the seat or steering wheel. ◀

Comfort mode

- Open the driver's door after unlocking or switch on radio readiness.
- Briefly press the desired memory button **1** or **2**.

The system cancels the adjustment procedure when you briefly press one of the seat adjustment switches or one of the memory buttons.

Safety feature

- Close the driver's door and switch the ignition on or off.
- Press the desired memory button **1** or **2** and maintain pressure until the adjustment process has been completed.

If the **M** button was pressed inadvertently: press the button again; the LED goes out.

Head restraints

A correctly adjusted head restraint reduces the risk of spinal injury in the event of an accident.

 Adjust the head restraint so that its center is approx. at ear level. Otherwise there is increased danger of injury in the event of an accident. Only remove the head restraints if the respective seat is not occupied. Reinstall the head restraints before transporting passengers, as otherwise the head restraint cannot provide its protective function. ◀

Active front head restraints

In the event of a rear-end collision of sufficient severity, the active head restraint reduces the distance to the head.

 Do not use seat covers or head restraint covers that could impede the proper functioning of the active head restraint. Otherwise, there is no assurance that the active head restraint will perform its protective function and it is not possible to take advantage of its injury-reducing potential in the event of a rear-end collision.

Have the active head restraints reset after they are triggered in a rear-end collision. Have this work carried out only at a BMW Sports Activity Vehicle Center or at a workshop that works according to BMW repair procedures with correspondingly trained personnel. Otherwise, correct operation of this safety equipment is not guaranteed. ◀

 Removal and installation of the front head restraints should be performed by a BMW Sports Activity Vehicle Center. ◀

Front seats: height adjustment

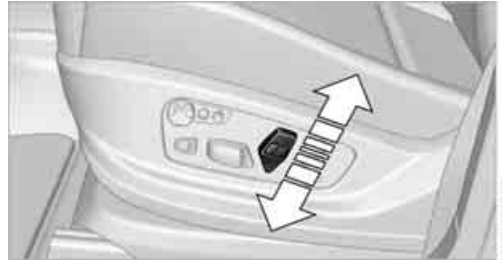

You can adjust the height of the head restraints electrically.

Front seats: adjusting distance from the back of the head



- ▷ Forward: pull up.
- ▷ Back: push the button and slide the headrest cushion toward the rear.

 Do not place any objects behind the headrest cushion. Otherwise, you can impair the proper function of the head restraint. ◀

Comfort seat*

You can adjust the distance from the back of the seat occupant's head using the shoulder support, refer to page 44.

Adjusting side extensions

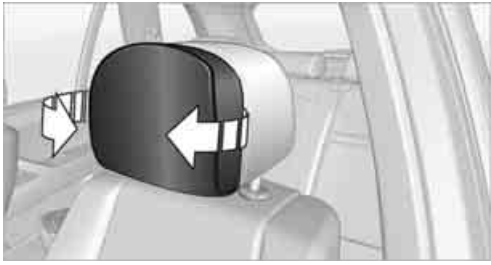

You can fold the side extensions on the head restraint forward for increased lateral support in the resting position.

Rear seat and 3rd row seats*: Height adjustment

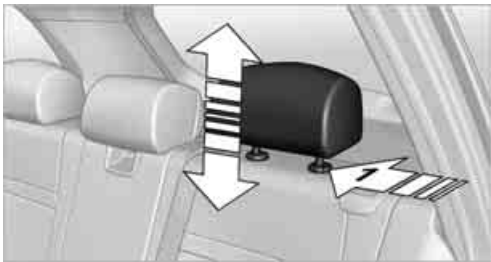

- ▷ To raise: pull up.
- ▷ To lower: press the button, arrow 1, and push the head restraint downward.

In vehicles equipped with 3rd row seats, the height of the middle head restraint is not adjustable.

Removing

1. Pull the head restraint upward to the stop.
2. Press the button, arrow 1, and pull the head restraint all the way out.

Rear seats

2nd row seats

With a divided* row of seats you can adjust both sides individually.

 Never adjust the 2nd row seats while the vehicle is moving, as otherwise the passengers on the 3rd row seats could be injured. Make sure that the locking devices of the 2nd row seats engage properly. Otherwise the restraining effect of the safety belts during an accident could be reduced. ◀

Longitudinal direction*

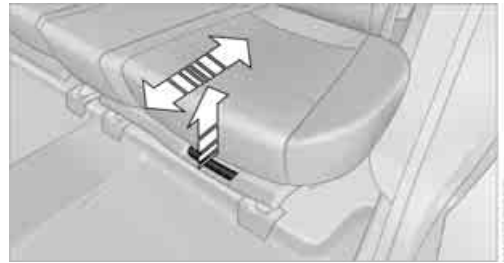

1. Pull the lever and slide the seat into the desired position.
2. Release the lever and move the seat slightly forward or back so that it engages properly.

Backrest*

The backrests can be adjusted in four steps.

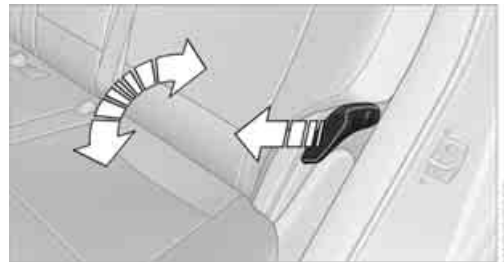



Pull the lever and apply weight to or remove weight from the backrest as needed.

Access to 3rd row seats*



Pull the lever and fold the seat forward.

 The handle recess on the interior trim of the door pillar makes climbing in easier. ◀

 When folding back the 2nd row seats, make sure that the footwell under the 2nd row seats is clear. Otherwise persons in the 3rd row seats could be injured or objects damaged. ◀

 Warning lamp for 2nd row seats: Lights up when the 2nd row seats are not locked. A message also appears on the Control Display.

3rd row seats*

The 3rd row seats are divided and offer space for two persons.

Folding up backrest

Before folding up the backrest, remove the roll-up cover, refer to page 122.

1. Pull the lever, refer to arrow. The backrest is unlocked.



2. Fold up and engage the backrest.

 Make sure that the catch engages securely. If it is not properly engaged, transported cargo could enter the passenger compartment during braking or evasive maneuvers and endanger the vehicle occupants. ◀

3. Push the head restraints into the top position.

Folding backrest down

1. Push down the head restraint, refer to page 47.
2. Pull the lever, refer to arrows. The backrests are released.



3. Fold the backrest down.

Safety belts

 To ensure that the safety systems continue to provide optimized protection, please observe the adjustment instructions on page 42. ◀

Before every drive, make sure that safety belts are being worn at all of the occupied seats. Airbags complement the safety belt as an additional safety device, but they do not represent a substitute.



Fastening

Make sure you hear the latch plate engage in the belt buckle.

Safety belt reminder for driver's seat and passenger seat



The indicator lamp lights up and a signal sounds. A message also appears on the Control Display.

Please check whether the safety belt is correctly fastened.

The safety belt reminder is operative at speeds above approx. 5 mph/8 km/h. It can also be activated if objects are placed on the passenger seat.

Releasing

1. Grasp the belt firmly.
2. Press the red button in the buckle.
3. Guide the belt into its reel.

The shoulder strap's anchorage point will be correct for adult seat occupants of every build if the seat is correctly adjusted, refer to page 43.

The two rear safety belt buckles integrated into the rear seat are for passengers sitting on the left and right. The belt buckle embossed with the word CENTER is intended exclusively for use by passengers riding in the center position.

Damage to safety belts



In the event of loads caused by accidents or other damage: replace the belt system including the safety belt tensioners and any child restraint systems, and have the belt anchor points checked. Only have this work carried out at a BMW Sports Activity Vehicle Center or at a workshop that works according to BMW repair procedures with correspondingly trained personnel. Otherwise correct operation of this safety equipment is not guaranteed. ◀

Belt-force limiter

The effect of the belt-force limiter on the driver's seat is dependent on the position of the driver's seat.

To maintain the long-term accuracy of this function, the driver's seat must be calibrated if a corresponding message is displayed on the Control Display.

Calibrating driver's seat



The warning lamp lights up. A message also appears on the Control Display. Please calibrate the driver's seat.

1. Move the driver's seat forward until it stops.
2. Move the driver's seat forward again. It briefly moves toward the front in the process.
3. Set the desired seating position again.

The calibration is completed when the message on the Control Display disappears. Should this message continue to be displayed, repeat the calibration. If the message does not disappear even after repeated calibration, have the system checked as soon as possible.



Never carry out calibration while the vehicle is moving, as this can cause accidents. Make sure that no persons or objects become wedged during the calibration process, as this can cause injuries or damage. ◀

Seat heating*

Front

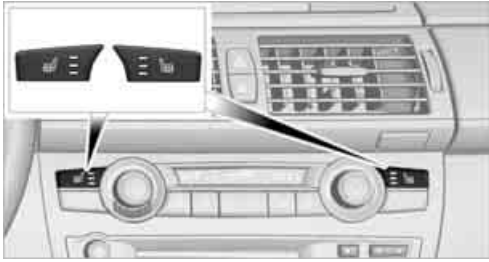

The temperature setting progresses one step through its control sequence each time you press the button. The maximum temperature is supplied when three LEDs are lit.

To switch off: press the button longer.

The temperature is reduced, if need be, down to no heat in order to reduce the load on the battery. The LEDs remain lit.

Temperature distribution*

The heat output can be distributed variously in the seat cushion and the backrest.

iDrive, for operating principle refer to page 16.

1. Open the start menu.
2. Move the controller to the left to open "Climate".
3. Select "Seat heater distribution" and press the controller.
4. Move the controller to the left or right to select "Driver" or "Passenger".

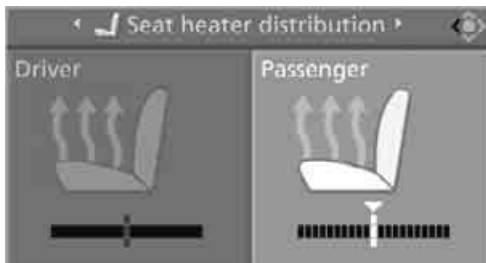

5. Turn the controller. The adjustment is applied; the field can be changed.

Rear



Operation similar to front seat heating; without temperature distribution.

Active seat ventilation* and seat heating*

Front

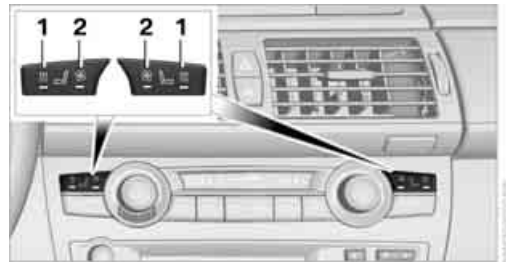

- 1 Seat heating
- 2 Active seat ventilation

Press button **1** or **2** once depending on the temperature or ventilation position. The LED in the respective button lights up.

The temperature or ventilation levels are shown on the Control Display.

The air quantity is reduced and if need be, the ventilation is switched off in order to reduce the load on the battery. The LEDs remain lit.

To switch off: press button **1** or **2** longer.

Temperature distribution

The heat output can be distributed variously in the seat cushion and the backrest.

iDrive, for operating principle refer to page 16.

1. Open the start menu.

2. Move the controller to the left to open "Climate".
3. Select "Driver's seat climate" or "Passenger's seat climate" and press the controller.
4. Turn the controller to adjust the distribution.
The setting is applied.



Heated rear seats

Operation similar to front seat heating; without temperature distribution, refer to page 50.

Active seat*

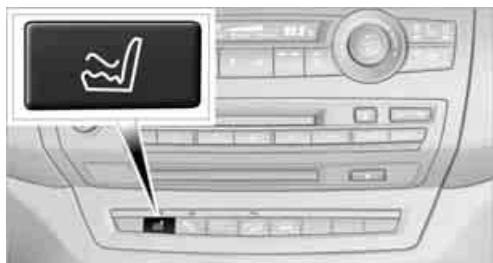

The seat cushion is actively varied by alternately raising and lowering the right and left half of the seat cushion. This reduces muscular tension and fatigue to help prevent lower back pain.

Press the button to switch on; the LED lights up.

The action of the system is reduced and if need be, switched off in order to reduce the load on the battery. The LED remains lit.

If you switch off the active seat, it can take up to 1 minute before the two halves of the seat cushion have returned to their initial position.

Mirrors

Exterior mirrors

 The mirror on the passenger's side is more curved than the driver's mirror. Objects reflected in the mirror are closer than they appear. Do not estimate the distance of following traffic based on what you see in the mirrors; otherwise, there is an increased risk of accident. ◀

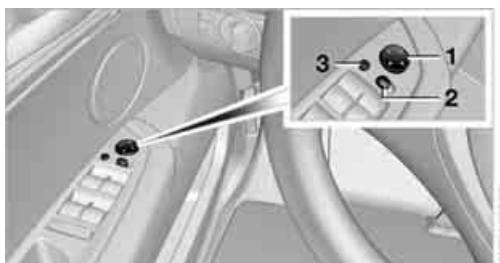

- 1 Adjusting
- 2 Switching to the other mirror or to the automatic curb monitor
- 3 Folding mirrors in and out*

Storing the mirror positions, refer to Seat, mirror and steering wheel memory on page 44.

Adjusting manually

The mirrors can also be adjusted manually: press the edge of the glass.

Folding mirrors in and out*

Pressing button **3** allows you to fold the mirrors in and out again up to a speed of approx. 12 mph/20 km/h. This is advantageous, for example, in car washes, narrow streets or for bringing mirrors that have been manually folded in back into the correct position. Folded in mirrors fold out again at a speed of approx. 25 mph/40 km/h.

 Before going through a car wash, fold the mirrors in manually, or with button **3**, otherwise they could be damaged, depending on the width of the car wash system. ◀

Automatic heating

Below a certain outdoor temperature, both exterior mirrors are automatically heated when the motor is running or the ignition is switched on.

Tilting down passenger-side exterior mirror – automatic curb monitor*

Activating

1. Slide switch into the driver's side mirror position, arrow 1.

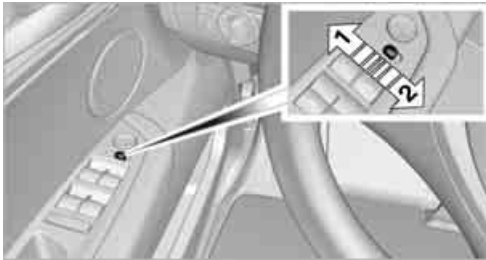

2. Engage transmission position R. The mirror glass tilts downward somewhat on the passenger's side. This allows the driver to see the area immediately adjacent to the vehicle – such as a curb – when parking, etc.

Deactivating

Slide switch into the passenger side mirror position, arrow 2.

Interior rearview mirror



To reduce the dazzle effect of following vehicles at night, turn the knob.

Interior and exterior mirrors, automatic dimming feature*

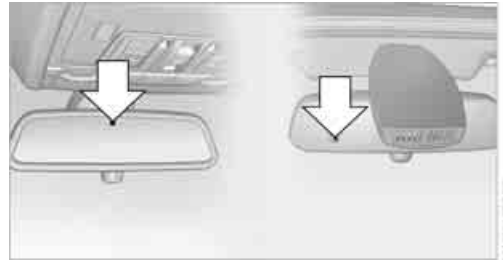

This feature is controlled by two photocells in the interior rearview mirror. One is integrated into the glass of the mirror, while the other is located at an offset position on the rear of the mirror housing.

For trouble-free operation, keep the photocells clean and do not cover the area between the interior rearview mirror and the windshield. Do not attach stickers of any kind to the windshield in front of the mirror, either.

Steering wheel

Adjusting

⚠ Do not adjust the steering wheel while the vehicle is moving. There is a risk of accident as the result of unexpected movement. ◀

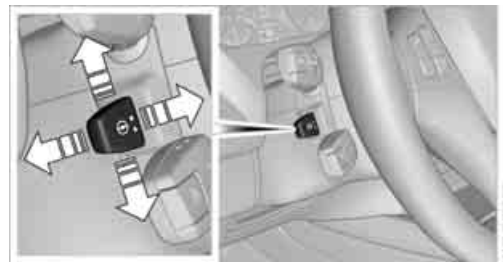

The steering wheel can be adjusted in four directions.

Storing steering wheel positions, refer to Seat, mirror and steering wheel memory on page 44.

Easy entry/exit*

To facilitate entry and exit, the steering wheel temporarily moves into the uppermost position.

Steering wheel heating*



Press the button.

When the steering wheel heater is switched on, the LED in the button lights up.

Programmable buttons on steering wheel



You can program the buttons individually.

The setting is stored for the remote control currently in use.

iDrive, for operating principle refer to page 16.

1. Press the **MENU** button.
This opens the start menu.
2. Press the controller to open the **i** menu.

3. Select "Settings" and press the controller.



4. Select "Steering wheel buttons" and press the controller.

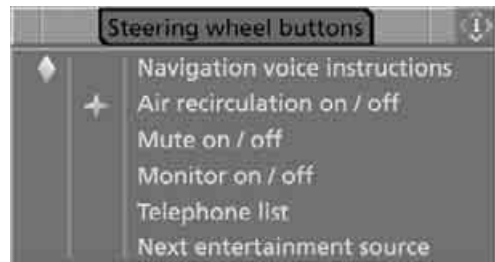

A list of different functions appears:

- ▷ "Navigation voice instructions"
Voice instructions for the navigation system*
 - ▷ "Air recirculation on / off"
Permanently shutting off outside air, refer to AUC Automatic recirculated-air control* on page 109
 - ▷ "Mute on / off"
Mutes the audio sources
 - ▷ "Monitor on / off"
Switches the Control Display on/off
 - ▷ "Telephone list"*
Display/hide phone book or last list of stored phone numbers
 - ▷ "Next entertainment source"
Changes audio source
5. Select the desired function and press the controller.

6. Select the button if necessary and press the controller.



You can operate the selected function using the corresponding button.

Operating function

Press the corresponding button on the steering wheel.

If you have programmed "Navigation voice instructions" for one of the buttons:

- ▷ To switch voice instructions on/off:
Hold the button down.
- ▷ To repeat the last voice instruction:
Press the button.

Transporting children safely

The right place for children

 Do not leave children unattended in the vehicle, otherwise they could endanger themselves and other persons, e.g. by opening the doors. ◀

Children always in rear

Accident research shows that the safest place for children is on the rear seat.

 Children younger than 13 years of age or with a height under 5 ft/150 cm may only be transported on the 2nd row seats in child restraint systems which correspond to the age, weight and height of the child. Otherwise there is an increased danger of injury in an accident. ◀

Children 13 years of age or older must wear a safety belt as soon as a suitable child restraint system can no longer be used due to their age, weight and size.

Exception for front passenger seat

 Should it be necessary to use a child restraint system on the front passenger seat, the front and side airbags on the passenger side must be deactivated. Otherwise, there is an increased risk of injury for the child if the airbags are triggered, even with a child restraint system. ◀

For more information on automatic deactivation of the front passenger airbags, refer to page 98.

Installing child restraint systems

 Follow the child restraint system manufacturer's instructions for selection, installation and use of child restraint systems. Otherwise, the degree of protection may be reduced. ◀

 For equipment with 3rd row seats*, make sure that the seat of the 2nd row seats on which the child restraint system is mounted is properly locked. Otherwise there is an increased risk of injury for the child in an accident.

Do not mount child restraint systems on the 3rd row seats, as otherwise the protection provided by these child restraint systems may be reduced. ◀

On front passenger seat

 After mounting a child restraint system on the front passenger seat, make sure that the front and side airbags on the front passenger side are deactivated; otherwise, there is an increased risk of injury if the airbags are triggered. ◀

Backrest width*

 The backrest width adjustment of the front passenger seat must be completely open. After installing the child's seat, no memory position may be called up; otherwise, the stability of the child's seat on the front passenger seat is reduced. ◀

1. Open backrest width adjustment completely, refer to page 44.
2. Install child's seat.

Child seat security



All safety belts of the 2nd and 3rd* row seats and the safety belt for the front passenger can be locked against pulling out.

Locking safety belt

1. Secure the child restraint system with the belt.
2. Pull out the belt webbing completely.
3. Allow the belt webbing to be pulled in and pull taut against the child restraint system. The safety belt is locked.

Unlocking safety belt

1. Open the belt buckle.
2. Remove the child restraint system.
3. Allow the belt webbing to be pulled in completely.

LATCH child restraint fixing system

LATCH: Lower Anchor and Tethers for CHildren.

 Follow the system manufacturer's instructions on installation and use of LATCH child restraint systems; otherwise, their protective function may be reduced. ◀

Before attaching the child's seat, pull the belt away from the region of the child restraint fixing system.

 Before installing the child's seat, remove the covers* from the mounts for the LATCH anchor fittings, as otherwise the LATCH anchor fittings have no restraining effect. ◀



 Make sure that the LATCH mounts have properly clicked into place and that the child restraint system is resting snugly against the backrest. Otherwise, the protective action may be reduced. ◀

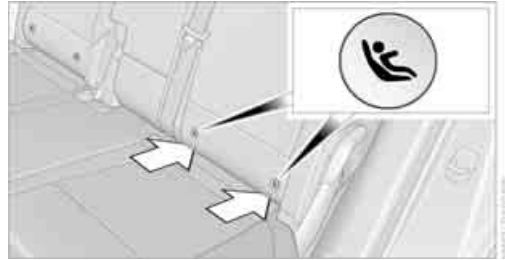

The anchor points for the LATCH anchors are located at the positions indicated by arrows in the gap between the seat and the backrest.

Child restraint system with tether strap

 Only use the top tether mounting points to secure child restraint systems, otherwise the mounting points could be damaged. Do not mount child restraint systems on the 3rd row seats, as otherwise the protection provided by these child restraint systems may be reduced. ◀

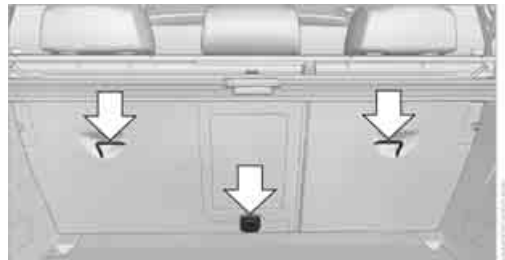

There are three additional mounting points for child restraint systems with a tether strap on the 2nd row seats, refer to arrows. Fold out before using the center mounting point.

Placement of tether strap

 Make sure that the tether strap is not routed over sharp edges and does not twist on its way to the mounting point; otherwise, the belt cannot properly secure the child restraint system in the event of an accident. ◀

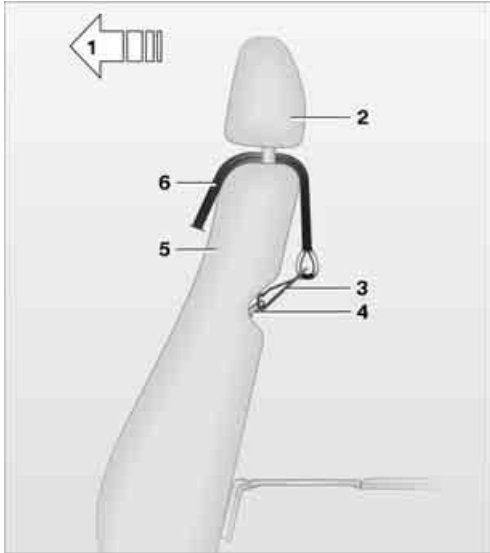

- 1 Direction of travel
- 2 Head restraint
- 3 Tether strap hook
- 4 Mounting point
- 5 Backrest
- 6 Tether strap of child restraint system

When using the cargo bay cover, route the tether strap through between the backrest of the 2nd row seats and the cargo bay cover.



Mounting tether strap on 2nd row seats

On outer seats:

1. Slide the head restraint upward.
2. Guide the tether strap between the head restraint brackets.
3. Hook in the tether strap on the mounting point with the hook.
4. Slide the head restraint into the bottom position.
5. Pull tether strap taut.

On center seat with equipment with two rows of seats:

1. Fold the center armrest somewhat toward the front.
2. Guide the tether strap through the opening in the center armrest.

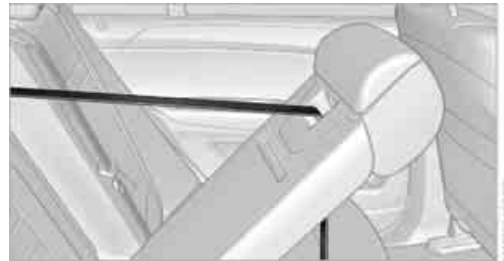

3. Fold back and engage the center armrest.
4. Hook in tether strap on mounting point.
5. Pull tether strap taut.

On center seat with equipment with three rows of seats:

1. Slide the head restraint upward.
2. Guide the tether strap between the head restraint brackets.
3. Hook in the tether strap on the mounting point with the hook.
4. Slide the head restraint into the bottom position.
5. Pull tether strap taut.

Ignition lock

Inserting remote control into ignition lock



Insert the remote control as far as possible into the ignition lock.

Radio readiness switches on. Some electronic systems/consumers are ready for operation.

Comfort access*

With comfort access, only insert the remote control into the ignition lock in exceptional cases, refer to page 36.

Removing remote control from ignition lock

 Do not pull the remote control out of the ignition lock using force, as otherwise damage may result. ◀

Before removing the remote control, first press it in as far as possible to release the locking device.

The ignition is switched off if it was still switched on.

Start/Stop button



Pressing the Start/Stop button switches the radio readiness or the ignition on and off.

 Pressing the Start/Stop button with the brake pedal depressed starts the engine. ◀

Radio readiness

Some electronic systems/consumers are ready for operation. The time and outside temperature are displayed in the instrument panel.

Radio readiness is automatically switched off:

- ▶ when the remote control is removed from the ignition lock
- ▶ with comfort access* by touching the sensitive surface above the door lock, refer to Locking on page 36

Ignition on

All electronic systems/consumers are ready for operation. The odometer and the trip odometer are displayed in the instrument panel, refer to page 71.

 Please switch off the ignition and the electronic systems/consumers which are not required when the engine is not running to save the battery. ◀

Radio readiness and ignition off

All indicator lamps, warning lamps, and displays in the instrument panel go out.

Starting engine

 Do not run the engine in closed rooms, otherwise the inhalation of toxic exhaust gases can cause unconsciousness and death. The exhaust gases contain carbon monoxide, an odorless and colorless, but highly toxic gas. Never leave an unattended vehicle with the engine running, as such a vehicle represents a potential safety hazard.

To prevent the vehicle from rolling, always engage transmission position N or P and set the parking brake before leaving the vehicle with the engine running. ◀

Do not allow the engine to warm up by leaving it running while the vehicle remains stationary. Instead, drive off at a moderate engine speed.

 The engine starts when you depress the brake pedal while pressing the Start/Stop button. ◀

 Avoid frequent starting in quick succession or repeated starting attempts in which the engine does not start. Otherwise, the fuel is not burned or inadequately burned and there is a danger of overheating and damaging the catalytic converter. ◀

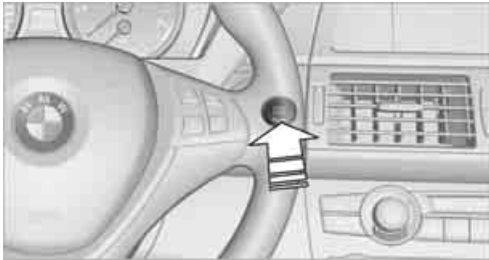

Remote control in ignition lock or with comfort access in vehicle, refer to page 36.

1. Depress brake pedal.
2. Press the Start/Stop button.

The system responds by automatically engaging the starter for a certain period and automatically disengaging it as soon as the engine starts.

Switching off engine

 When leaving the vehicle, always take along the remote control. Set the parking brake firmly when parking; otherwise, the vehicle could roll. ◀

Procedure

1. Engage transmission position P with the vehicle stopped.
2. Press the Start/Stop button.
3. Set the parking brake.
4. Remove the remote control from the ignition lock, refer to page 59.

Before driving into a car wash

The vehicle can roll if you proceed according to the following steps:

1. With comfort access*: insert the remote control into the ignition lock.
2. Depress brake pedal.
3. Engage transmission position N.
4. Release the parking brake or deactivate Automatic Hold.
5. Switch off the engine.

Transmission position P will be engaged:

- ▷ automatically after approx. 30 minutes
- ▷ if you remove the remote control from the ignition lock

Parking brake

The concept

Your BMW is equipped with an electromechanical parking brake.

The parking brake is primarily intended to prevent the vehicle from rolling while parked.

You can use the parking brake in two ways:



- ▷ manually, by pulling and pushing the button
- ▷ automatically, by activating Automatic Hold, refer to page 61

With the engine stopped, the parking brake acts on the rear wheels via an electromechanical system. When the engine is running, the parking brake acts on the disk brakes of the front and rear wheels via the brake hydraulics.

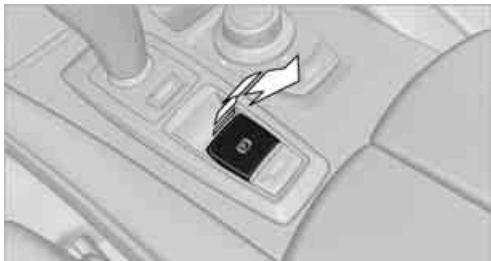
Setting manually





Pull button. The parking brake is set.

-  The indicator lamp in the instrument panel lights up red. The parking brake is set.
-  Indicator lamp on Canadian models.

The remote control does not have to be inserted into the ignition lock for the parking brake to be set.

While driving

If exceptional circumstances should make it necessary to set the parking brake while the vehicle is in motion, pull on the button longer. The vehicle continues to brake forcefully for as long as you pull on the button.



-  The indicator lamp in the instrument panel lights up red, a chime sounds and the brake lamps light up.
-  Indicator lamp on Canadian models.

As soon as you brake the vehicle almost to a stop, i.e., down to a speed of approx. 2 mph/ 3 km/h or below, the parking brake remains set.

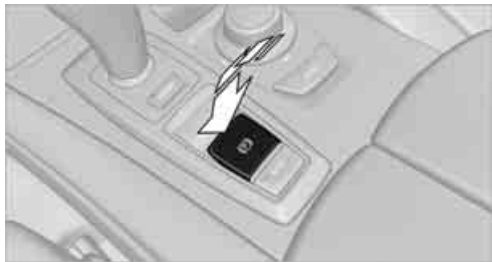
Releasing manually



Press the button with the brake depressed.

-  The indicator lamp in the instrument panel goes out.
-  Indicator lamp on Canadian models.

 When leaving the vehicle, always take along the remote control; this precaution prevents children from releasing the parking brake, for example. ◀

Automatic Hold

The concept

This function assists you while you drive by automatically setting and releasing the parking brake, e.g. when you are stopped at a traffic signal or in stop-and-go traffic.

When Automatic Hold is activated, the vehicle is automatically held in place when standing. When driving up inclines, the system prevents your vehicle from rolling backward in an undesired way.

After the engine is started, the system can be activated and deactivated at any time the driver's seat is occupied until the next time the engine is switched off.

Activating

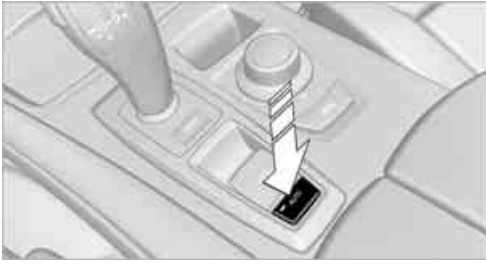

Press the button. The LED in the button lights up and the indication AUTO H appears in the instrument panel. Automatic Hold is activated.

 If the vehicle is being held by Automatic Hold, the indicator light in the instrument panel also lights up in green.

 Indicator lamp on Canadian models.

Deactivating

Press the button again, the LED in the button and the indication AUTO H in the instrument panel go out. Automatic Hold is deactivated.

If the vehicle is being held by Automatic Hold, then press on the brake pedal to deactivate it.

When the parking brake is set manually, refer to page 61, Automatic Hold is automatically deactivated.

Driving

With Automatic Hold activated, the vehicle is automatically prevented from rolling after it comes to a stop.

 The indicator lamp in the instrument panel lights up in green.

 Indicator lamp on Canadian models.

If the transmission is in a drive position, simply press on the gas pedal to begin driving. The

brake is automatically released and the indicator lamp goes out.

 Before driving into the car wash, deactivate Automatic Hold; otherwise, the parking brake will be automatically set after stopping and the vehicle can no longer roll. ◀

Parking

If the vehicle is being held by Automatic Hold and you switch off the motor, the parking brake is automatically set.

 The indicator lamp in the instrument panel changes from green to red.

 Indicator lamp on Canadian models.

 The parking brake is not set if you have already switched off the engine while the vehicle is rolling to a stop. Automatic Hold is deactivated. ◀

You can manually release the parking brake even after switching off the motor as long as the remote control remains in the ignition lock, refer to page 61. Use this function in car washes, for example.

 When leaving the vehicle, always take along the remote control; this precaution prevents children from releasing the parking brake, for example. ◀

For your safety

Automatic Hold is automatically deactivated when:

- ▷ the engine is switched off
- ▷ no one is detected in the driver's seat when the engine is running
- ▷ the vehicle is braked to a stop during driving.

 In the instrument panel, the indicator lamp changes from green to red and the indication AUTO H goes out.

 Indicator lamp on Canadian models.

Before you start to drive, either release the parking brake manually, refer to page 61, or reactivate Automatic Hold, refer to page 62.

 Before leaving the vehicle with the engine running, shift the selector lever into position P of the automatic transmission and make sure that the parking brake is set. Otherwise, the vehicle may begin to roll. ◀

Malfunction

If the parking brake fails or malfunctions, secure the vehicle against rolling, e.g. with a wheel chock, if you leave the vehicle.

Releasing parking brake manually

In the event of an electrical power loss or electrical malfunction, you can release the parking brake manually.

 Before manually releasing the parking brake and each time you park the vehicle without setting the parking brake, make sure that the automatic transmission is in position P, refer to page 65. Be sure to pay attention to the information in the instrument panel.

In addition, secure the vehicle against rolling, e.g. with a wheel chock. Otherwise there is a danger that the vehicle could roll if parked on a steep slope. ◀

If it becomes necessary to also release the transmission lock of the automatic transmission manually, follow this sequence:

1. If necessary, start by releasing the parking brake manually.
2. Then release the automatic transmission's transmission lock manually, refer to page 65.

Jump starting and towing, refer to information starting on page 256.

Releasing

1. Open the left-hand side panel in the cargo bay.
2. Remove the first-aid kit* and the warning triangle* if necessary. Close the bracket of the warning triangle.

3. Insert the releasing tool, contained in the onboard tool kit under the floor panel, refer to page 247, at the releasing point.



4. Firmly pull the releasing tool upward against the mechanical resistance, refer to arrow, until a considerable increase in force is felt and the parking brake is then clearly heard to release.
5. Stow the releasing tool, warning triangle* and first-aid kit* and close the left side panel in the cargo bay.

 Only have a malfunction corrected by the nearest BMW Sports Activity Vehicle Center or a workshop that works in accordance with BMW guidelines and uses appropriately trained personnel. If the parking brake has been released manually in response to a malfunction, only technicians can return it to operation. ◀

 Following manual release, the actual status of the parking brake may deviate from that displayed by the indicator lamp. ◀

Operation after interruptions in power supply

 The parking brake can only be used again if it was manually released due to an interruption in the supply of electrical power. Otherwise the operation of the parking brake is not ensured and there is a danger of the vehicle rolling despite the parking brake being set. ◀

Procedure

1. Switch on the ignition.
2. Press the button with the brake depressed.

 The indicator lamp in the instrument panel goes out as soon as the parking brake is ready for operation again.

 Indicator lamp on Canadian models.

Any noises which occur are normal. Start-up may take several seconds.

Automatic transmission with Steptronic

In addition to fully automatic operation, you can also manually shift with the Steptronic, refer to page 65.

Transmission positions

P R N D M/S + -

 To prevent the vehicle from creeping after you select a driving position, maintain pressure on the brake pedal until you are ready to start. ◀

Displays in instrument panel



P R N D DS M1 to M6

The transmission position is indicated, and in the manual mode, the gear currently engaged.

Engaging transmission position

- ▷ You can only engage transmission positions D, R or N when the engine is running.
- ▷ With the vehicle stationary, depress the brake pedal before shifting out of P or N; otherwise the shift command will not be executed: shiftlock.

 To prevent the vehicle from creeping after you select a driving position, maintain pressure on the brake pedal until you are ready to start. ◀

Shifting into D, R, N

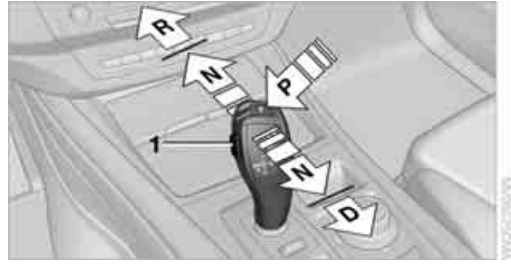

Briefly press the selector lever in the desired direction, beyond a resistance point if necessary. When shifting out of P or into R, simultaneously push the button 1.

The engaged transmission position is displayed on the selector lever.

The selector lever immediately returns to the center position when released.

Engaging P



Press button P.

Also observe the additional information on the automatic transmission.

 The transmission automatically shifts into park if you release the driver's seatbelt and open the driver's door with the engine running while in reverse or drive. ◀

R Reverse

Select only when the vehicle is stationary.

An interlock prevents inadvertent gearshifts into transmission position R. To deactivate the interlock, press the release button 1.

P Park

Select only when the vehicle is stationary. The rear wheels are locked.

 P is engaged automatically as soon as you switch off the engine unless N is engaged and on vehicles with comfort access the remote control is inserted in the ignition lock, refer to page 59. ◀

N Neutral

Can, for example, be engaged in automatic car washes. The vehicle can roll.

 N remains engaged even after the engine is switched off whenever you leave the remote control in the ignition lock. This function is used, for example, in a car wash, refer to page 60. After approx. 30 minutes P is automatically engaged. ◀

D Drive, automatic position

Position for normal vehicle operation. All forward gears are available.

Under normal operating conditions, the fuel consumption is lowest when driving in position D.

Kick-down

The kick-down mode provides maximum acceleration.

Press the accelerator pedal beyond the increased resistance at full throttle.

Sport program and manual mode M/S



Press selector lever out of transmission position D toward the left:

The sport program is activated and DS appears in the instrument panel. This position is recom-

mended for a performance-oriented driving style.

When the selector lever is pressed forward or back, the manual mode is activated and the Steptronic shifts the gear. The instrument panel shows M1 through M6.

Upshifts and downshifts are executed only when they will result in a plausible combination of engine and vehicle speed; thus, for example, a downshift that would cause the engine to overrev will not be executed by the system. The selected gear is briefly displayed in the instrument panel, followed by the current gear.

To use the automatic function again, press the selector lever to the right into position D.

Manually releasing and engaging transmission lock

 In case of a power failure, e.g. when the battery is drained or disconnected, or an electrical malfunction, the transmission lock must be manually released, as otherwise the rear wheels are blocked and the vehicle cannot be towed. ◀

 Step on the brake when manually releasing the transmission lock; otherwise, there is a danger of the vehicle rolling. ◀

The transmission lock should only be released for towing. Reengage the transmission lock after parking the vehicle at its destination.

If it also becomes necessary to manually release the parking brake, follow this sequence:

1. Secure the vehicle against rolling.
2. Manually release the parking brake, refer to page 63.
3. Manually release the transmission lock of the automatic transmission.

Releasing

1. Slide back the cover of the cup holder and remove the floor mat on the bar between the cup holders, arrow 1.



2. Open the cover in the bottom of the cup holder with the releasing tool from the onboard tool kit, page 247, refer to arrow 2.
3. If necessary, unlock the lock* with the integrated key of the remote control, refer to page 28, and remove it.
4. Insert the releasing tool into the opening, arrow 3.



5. Turn the releasing tool as far as possible, arrow 4, and then press downward and leave it in. The transmission lock is released.

⚠ Engage the transmission lock after parking the vehicle at its destination. Otherwise there is a danger of the vehicle rolling. ◀

Locking



1. Pull out the releasing tool. The transmission lock is engaged again.
2. If necessary, insert the lock* and lock it.
3. Close the cover in the bottom of the cup holder and lay in the mat again.
4. Close the cover of the cup holder and stow the releasing tool.

Information on jump starting and towing, from page 256.

Turn signals/headlamp flasher/high beams

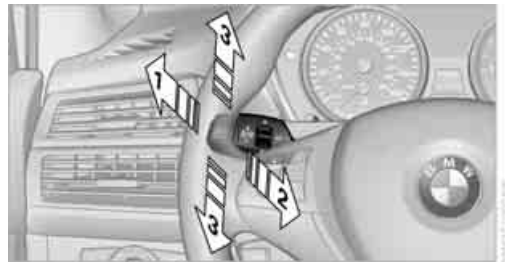

- 1 High beams
- 2 Headlamp flasher
- 3 Turn signals

Using turn signals

Press the lever beyond the resistance point.

To switch off manually, press the lever up to the resistance point.

▷ Atypically rapid flashing of the indicator lamp indicates that a turn signal bulb needs to be replaced. ◀

Signaling briefly

Press lever to resistance point and hold for as long as you wish to signal.

Triple turn signal activation

Press the lever up to the resistance point. The turn signal flashes three times.

You can activate or deactivate this function. iDrive, for operating principle refer to page 16.

1. Press the **MENU** button.
This opens the start menu.
2. Press the controller to open the **i** menu.
3. Select "Settings" and press the controller.
4. Select "Vehicle / Tires" and press the controller.
5. Change to upper field if necessary. Turn the controller until "Lighting" is selected and press the controller.



6. Select "Triple turn signal" and press the controller.
 Triple turn signaling is activated.

The setting is stored for the remote control currently in use.

Washer/wiper system

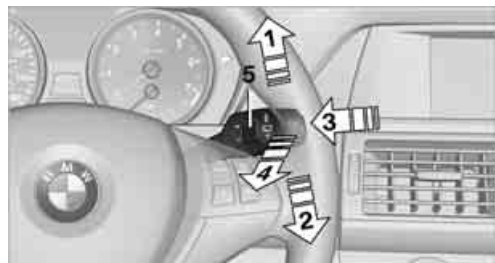

- 1 Switching on wipers
- 2 Switching off wipers or brief wipe
- 3 Activating/deactivating intermittent wipe or rain sensor*
- 4 Cleaning windshield and headlamps*
- 5 Setting interval for intermittent wipe, or sensitivity of the rain sensor

Switching on wipers

Pull the lever upward, arrow 1.

The lever automatically returns to its initial position when released.

Normal wiper speed

Press once.

The system reverts to operation in the intermittent mode when the vehicle is stationary.

Fast wiper speed

Press twice or press beyond the resistance point.

The system reverts to normal speed when the vehicle is stationary.

Intermittent operation or rain sensor*

With the rain sensor, the wiper operation is controlled automatically as a function of the rain intensity. The rain sensor is located on the windshield, directly in front of the interior rear-view mirror.

Activating intermittent operation or rain sensor



Press the button, arrow **3**. The LED in the button lights up.

Setting interval for intermittent wipe, or sensitivity of the rain sensor

Turn the knurled wheel **5**.

Deactivating intermittent operation or rain sensor

Press the button again, arrow **3**. The LED goes out.

⚠ Deactivate the rain sensor when passing through an automatic car wash. Failure to do so could result in damage caused by undesired wiper activation. ◀

Cleaning windshield and headlamps*

Pull the lever, arrow **4**.

The system sprays washer fluid against the windshield and activates the wipers for a brief period.

When the vehicle lighting system is switched on, the headlamps are also cleaned at regular and appropriate intervals.

⚠ Do not use the washers if there is any danger that the fluid will freeze on the windshield. If you do so, your vision could be obscured. To avoid freezing, use a washer fluid antifreeze, refer to Washer fluid. Do not use washing mechanisms when the washer fluid reservoir is empty, otherwise you will damage the washer pump. ◀

Windshield washer nozzles

Both windshield washer nozzles are automatically heated with the engine running or the ignition switched on.

Rear window wiper



- 1** Intermittent mode. When reverse gear is engaged, continuous operation is switched on automatically
- 2** Cleaning the rear window

⚠ Do not use washing mechanisms when the washer fluid reservoir is empty, otherwise you will damage the washer pump. ◀

Washer fluid

⚠ Washer fluid antifreeze is flammable. For this reason, keep it away from ignition sources and store only in the closed original container out of reach of children. Otherwise, there is the danger of bodily injury. Always observe the instructions for use provided on the containers. ◀

Filler neck for washer fluid

⚠ Only add washer fluid with the engine cooled down to exclude contact with hot engine components. Otherwise there is a danger of fire and to personal safety if the fluid is spilled. ◀

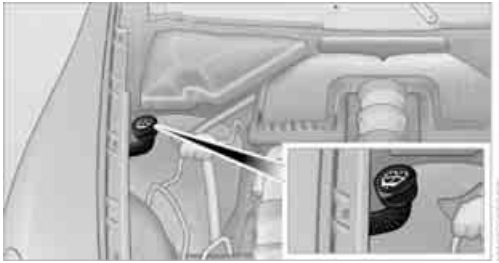

All washer nozzles are supplied from one reservoir.

Fill with water and – if required – with a washer antifreeze, according to manufacturer's recommendations.



In order to maintain the mixture ratio, mix the washer fluid before filling. ◀

Capacity

approx. 6.3 US quarts/6 liters.

Cruise control*

The concept

The cruise control with a braking function is available for use at speeds of approx. 20 mph/30 km/h and higher. The vehicle stores and maintains the speed that you set using the lever mounted on the steering column. To keep the specified speed constant, the system brakes if the engine braking effect is not sufficient on a downhill grade.



Do not use the cruise control under driving conditions that do not permit a constant speed, e.g. when driving on winding roads, in heavy traffic or in poor road conditions such as snow, rain, ice, and loose road surface. Otherwise you could lose control of the vehicle and cause an accident. ◀

One lever for all functions

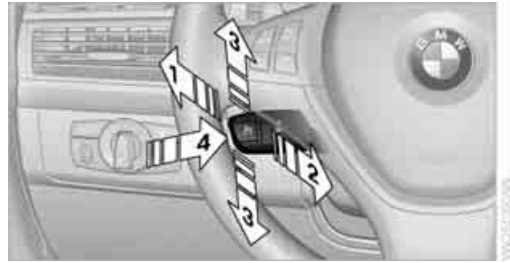

- 1 Storing speed and maintaining or increasing
- 2 Storing speed and maintaining or decreasing
- 3 Deactivating cruise control
- 4 Resuming stored speed

Maintaining current speed

Briefly press, arrow 1, or briefly pull, arrow 2 lever.

The speed currently being driven is stored and maintained. It is indicated on the speedometer and briefly in the instrument panel.

The controlled speed can drop on uphill grades if the engine output is insufficient. If the engine braking effect is not sufficient on a downhill grade, the system lightly brakes the vehicle.

Increasing speed

Repeatedly press the lever up to or beyond the resistance point, arrow 1, until the desired speed is set.

- ▷ Each time the lever is pressed to the resistance point, the speed is increased by approx. 1 mph or 1 km/h.
- ▷ Each time the lever is pressed beyond the resistance point, the desired speed increases by a maximum of 5 mph or 10 km/h.

The system stores the setting and maintains the set speed.

Accelerating with lever

Accelerate slightly:

Press the lever up to the resistance point, arrow **1**, until the desired speed is reached.

Accelerate more rapidly:

Press the lever beyond the resistance point, arrow **1**, until the desired speed is reached.

The vehicle accelerates without pressure on the accelerator pedal. The system stores the setting and maintains the set speed.

Reducing speed

Repeatedly pull the lever up to the resistance point or beyond, arrow **2**, until the desired speed is displayed.

- ▶ Each time the lever is pulled up to the resistance point, the desired speed decreases by approx. 1 mph or 1 km/h.
- ▶ Each time the lever is pulled beyond the resistance point, the desired speed is decreased by a maximum of 5 mph or 10 km/h until the minimum speed of 20 mph or 30 km/h is reached.

The system stores the setting and maintains the set speed.

Deactivating cruise control

Briefly press the lever up or down, arrow **3**. The displays in the speedometer go out.

In addition, the system is automatically deactivated:

- ▶ when braking
- ▶ when transmission position N is engaged
- ▶ when DTC is activated or DSC is deactivated
- ▶ when HDC is activated
- ▶ when the parking brake is set
- ▶ when driving stability control systems intervene

Accelerating does not deactivate the cruise control. After releasing the accelerator pedal, the stored speed is reached and maintained again.

Warning lamp



The warning lamp lights up if the cruise control has been deactivated automatically, e.g. by a control intervention of the DSC. A message appears on the Control Display.

Resuming stored speed

Briefly press the button, arrow **4**. The stored speed is resumed and maintained.

With the ignition switched off, the stored speed value is deleted and cannot be resumed again.

Displays in instrument panel



1 Stored desired speed

2 Selected desired speed appears briefly



If --- mph or --- km/h temporarily appears in the instrument panel display, it is possible that the system prerequisites for operation are currently not met. ◀

Malfunction



The warning lamp lights up if the system has failed. A message appears on the Control Display. Detailed information is provided from page [78](#).

Everything under control

Odometer, outside temperature display, clock

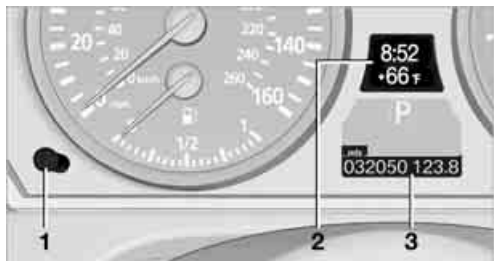

- 1 Knob in the instrument panel
- 2 Time, outside temperature, and date
- 3 Odometer and trip odometer

Knob in the instrument panel

- ▷ With ignition switched on
Press button:
Resetting trip odometer
Press the button for approx. 5 seconds:
Displaying service requirements, refer to page 75
- ▷ With ignition switched off
Press button:
Briefly displaying time, outside temperature and odometer

Units of measure

To select the respective units of measure, miles or km for the odometer as well as °F or °C for the outside temperature, refer to page 82.

The setting is stored for the remote control currently in use.

Time, date, outside temperature

From radio readiness the outside temperature and the time are displayed.

Setting the time, refer to page 81.

Retrieving date



Press the button on turn signal lever upward; the date appears.

To set the date, refer to page 82.

Pressing the button upward or downward several times changes the display between clock, outside temperature, date, and Check Control messages, refer to page 79.

Outside temperature warning

If the display drops to +37 °F / +3 °C, a signal sounds and a warning lamp lights up. A message appears on the Control Display. There is an increased danger of ice.

 Even at temperatures above +37 °F / +3 °C ice can form. Therefore, drive carefully, e.g. on bridges and sections of road in the shade, otherwise there is an increased accident risk. ◀

Odometer and trip odometer

Resetting trip odometer:
Press button 1 in the instrument panel with the ignition switched on.

When vehicle is parked

To briefly display the time, outside temperature and mileage after the remote control has been removed from the ignition lock:
Press button 1 in the instrument panel.

Tachometer



Do not operate the engine with the needle in the red overspeed zone of the gauge, refer to arrow. At high revs in this range, the flow of fuel is interrupted to protect the engine.

Coolant temperature

Should the coolant, and with it the engine become too hot, a warning lamp lights up. In addition, a message appears on the Control Display.

Checking coolant level, refer to page [244](#).

Energy Control



Displays the current fuel consumption. This allows you to see whether your current driving style is conducive to fuel economy with minimum exhaust emissions.

Fuel gauge



Fuel tank capacity: approx. 22.5 US gal/ 85 liters. You will find information on refueling on page [232](#).

If the tilt of the vehicle varies for a longer period, when you are driving in mountainous areas, for example, the indicator may fluctuate slightly.

Reserve

After the reserve quantity has been reached, a message briefly appears on the Control Display; the remaining range is shown in the computer. Below a range of approx. 30 miles/50 km, the message remains on the Control Display.

 Refuel as soon as possible once your cruising range falls below 30 miles/ 50 km, otherwise engine functions are not ensured and damage can occur. ◀

Computer

Displays in instrument panel

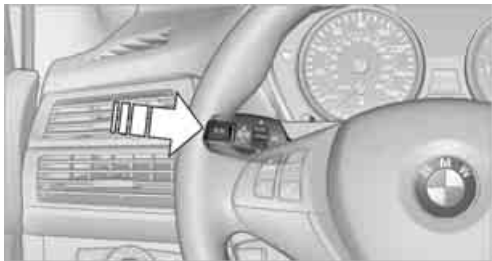

To display the information, press the BC button on the turn signal lever.

The following information is displayed in the specified order:

- ▷ Cruising range
- ▷ Average speed
- ▷ Average fuel consumption

Cruising range

Displays the estimated cruising range available with the remaining fuel. The range is projected based on the driving style over the last 20 miles/ 30 km.

 Refuel as soon as possible once your cruising range falls below 30 miles/ 50 km, otherwise engine functions are not ensured and damage can occur. ◀

Average speed

Periods with the vehicle parked and the engine stopped are not included in the calculations of average speed.

To reset average speed: press the BC button on the turn signal lever for approx. 2 seconds.

Average fuel consumption

The average fuel consumption is calculated for the time during which the engine is running.

To reset average fuel consumption: Press the BC button on the turn signal lever for approx. 2 seconds.

For different routes

You can display the average speed and average consumption for two different routes on the Control Display, refer to the following and to Trip computer*.

Displays on Control Display

You can also call up the computer via iDrive. For operating principle refer to page 16.

1. Press the **MENU** button.
This opens the start menu.
2. Move the controller to the right to open "Navigation".
Without navigation system*:
Open "Car Data".
3. Select "Car Data" and press the controller.

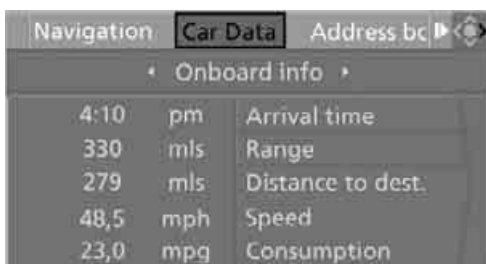

4. Select "Onboard info" and press the controller.



- ▷ Estimated time of arrival at destination and remaining distance:
 - ▷ Entering a distance manually in the computer, see below.
 - ▷ Entering a destination in the navigation system*, refer to page 138.
- ▷ Cruising range

- ▷ Average speed
- ▷ Average fuel consumption

Resetting values

You can reset the values for the average speed and average fuel consumption:

1. Select the respective menu item and press the controller.
2. To confirm your selection, press the controller again.

Entering a distance manually

1. Select "Distance to dest." and press the controller.

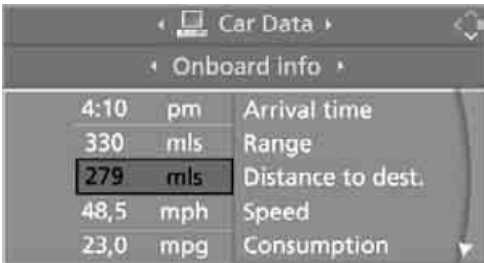

2. Turn the controller to select the distance to your destination.
3. Press the controller to apply the setting.

The distance is automatically preset during the destination guidance of the navigation system*.

Trip computer*

The trip computer is suitable, for example, for a vacation trip.

1. Open the start menu.
2. Open "Navigation".
Without navigation system*:
Open "Car Data".
3. Select "Car Data" and press the controller.

4. Select "Trip computer" and press the controller.

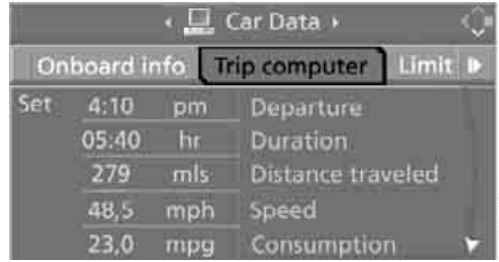

- ▷ Departure time
- ▷ Driving time
- ▷ Distance traveled
- ▷ Average speed
- ▷ Average fuel consumption

Starting or stopping the trip computer, or resetting all values:

1. Select "Set" and press the controller.
2. Select the desired menu item.
3. Press the controller.

Display options

You can display the computer or the trip computer in the assistance window.

1. Move the controller to the right to change to the assistance window and press the controller.

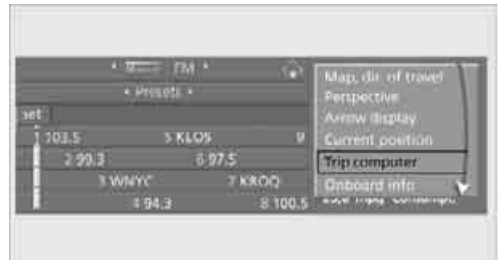

2. Select "Onboard info" or "Trip computer".

3. Press the controller.



Service requirements



The remaining driving distance and the date for the next maintenance are displayed briefly with the ignition switched on.

To determine the extent of maintenance required, you can also display the remaining distance or the service date individually in the instrument panel.

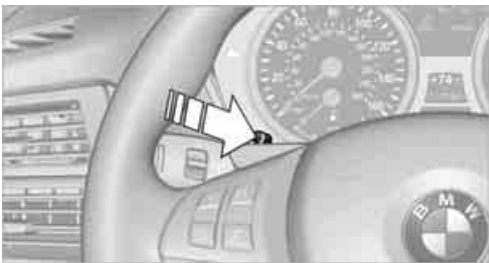

1. With the ignition switched on, press the button in the instrument panel, refer to page 71, for approx. 5 seconds until the service requirements are displayed.
2. Press the knob repeatedly to display the individual service requirement items.

Displaying service requirements



- 1 Button for selecting display
- 2 Service requirements
- 3 Engine oil
- 4 Legally mandated inspections*
- 5 Front brake pads

- 6 Rear brake pads
- 7 Brake fluid

The sequence of the displayed maintenance items can vary. First the data for the next maintenance are displayed.

Additional information

You can select a display of more detailed information on the maintenance scope on the Control Display. For operating principle refer to page 16.

1. Open the start menu.
2. Press the controller to open the **i** menu.
3. Select "Info sources" and press the controller.
4. Select "Service Info" and press the controller.

5. Change to upper field if necessary. Turn the controller until "Service requirements" is selected and press the controller.

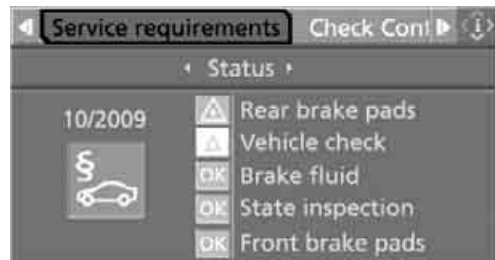

6. Select "Status" and press the controller.

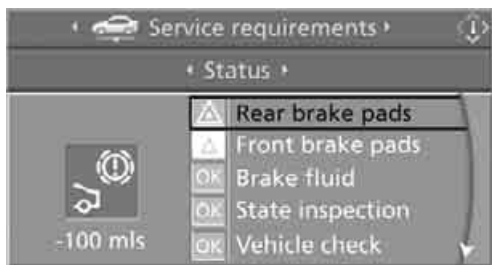

The display shows a list of selected service and maintenance procedures, as well as legally mandated inspections.

You can request more detailed information on every entry.

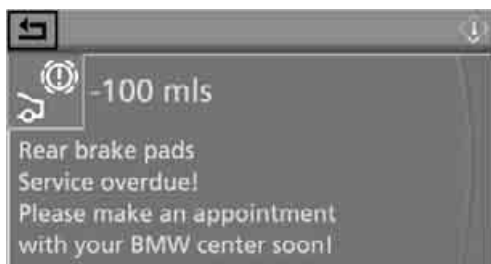

Select the entry and press the controller.



To exit from the menu:

↩ Select the arrow and press the controller.

Symbols

-  No service is currently required.
-  The deadline for service or a legally mandated inspection is approaching. Please arrange a service appointment.
-  The service deadline has already passed.

Entering deadlines for legally mandated inspections*

Make sure the date on the Control Display is set correctly, refer to page 82; otherwise, the effectiveness of CBS Condition Based Service is not ensured.

1. Open the start menu.
2. Press the controller to open the **i** menu.
3. Select "Info sources" and press the controller.
4. Select "Service Info" and press the controller.
5. Change to upper field if necessary. Turn the controller until "Service requirements" is selected and press the controller.
6. Select "Status" and press the controller.
7. Select "State inspection" and press the controller.

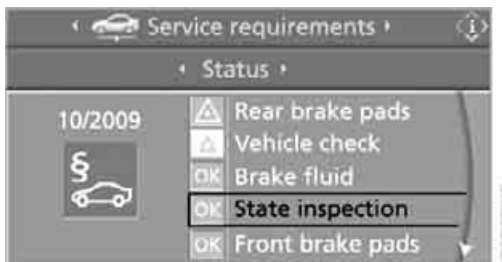

8. Select "Set service date" and press the controller. The month is highlighted.
9. Turn the controller to make the adjustment.



10. Press the controller to apply the setting. The year is highlighted.
11. Turn the controller to make the adjustment.
12. Press the controller to apply the setting. The date entry is stored.

To exit the menu:

↩ Select the arrow and press the controller.

Check Control

The concept

The Check Control monitors functions in the vehicle and issues a message if there is a malfunction in the monitored systems. This kind of Check Control message consists of indicator and warning lamps in the instrument panel, and if necessary an acoustic signal and text messages at the bottom of the Control Display.

Indicator and warning lamps



The indicator and warning lamps can light up in different combinations and colors.



▲ means that a Check Control message has been generated. The symbol continues to be visible even when the Check Control message disappears after a short time. The warning lamps and text messages are stored and can be displayed later, also refer to page 79.

Explanatory text messages



Text messages at the bottom edge of the Control Display explain the meaning of the displayed indicator and warning lamps.

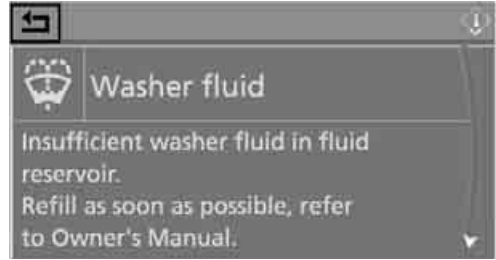

You can display additional information on most Check Control messages later, e.g. on the cause of the malfunction and on corresponding need for action, see below.

In the case of corresponding urgency, this information is displayed immediately when the related lamp lights up.

Exit the displayed information:

↶ Select the arrow and press the controller.

Hiding Check Control messages

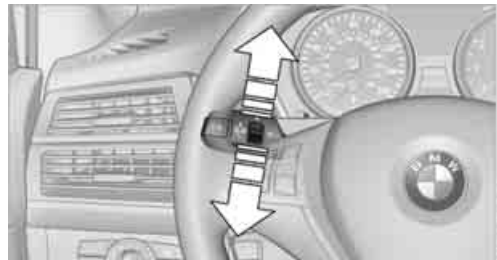

Press the button in the turn signal lever up or down.

Some Check Control messages are displayed until the malfunctions have been rectified. They cannot be hidden. If a number of malfunctions occur simultaneously, they are displayed in succession.

Other messages are automatically hidden after approx. 20 seconds, but remain stored.

Displaying stored Check Control messages



1. Press the button on the turn signal lever downward. "CHECK OK" or the stored Check Control messages appear in the display. "CHECK OK" is shown if no messages are present. Check Control messages are accompanied by text messages on the Control Display.
2. Press the button to display additional messages, the time and outside temperature, or the date.

Displaying additional information later

iDrive, for operating principle refer to page 16.

1. Press the **MENU** button.
This opens the start menu.
2. Press the controller to open the **i** menu.
3. Select "Info sources" and press the controller.
4. Select "Service Info" and press the controller.

5. Change to upper field if necessary. Turn the controller until "Check Control messages" is selected and press the controller.

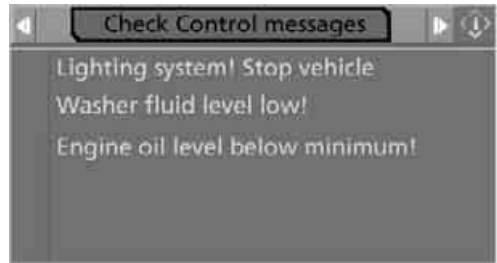

6. Select a text message and press the controller.

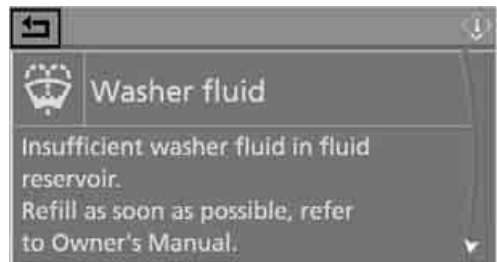

To exit the display:

- ➡ Select the arrow and press the controller.

Indication of malfunction urgency

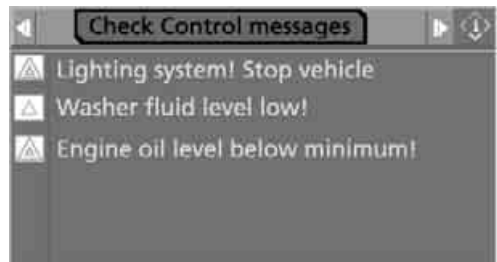

Depending on your vehicle's equipment, the stored Check Control messages are also displayed with the following symbols:

- No malfunctions are present in the monitored systems.
- Malfunctions are present in the monitored systems. Depending on the malfunction, supplementary information is shown on the Control Display.
- Malfunctions are present in the monitored systems. Depending on the malfunction, supplementary information is shown on the Control Display.

The symbols also indicate the status of the service requirements display, refer to page 77.

Speed limit

You can enter a speed and a Check Control message indicates when you have reached this speed. This enables you, for example, to receive warnings if you exceed a speed limit in an urban area.

You are only warned of reaching this speed a second time if your vehicle speed falls below it again by at least 3 mph/5 km/h.

Displaying, setting or changing limit

iDrive, for operating principle refer to page 16.

1. Open the start menu.
2. Open "Navigation".
Without navigation system*:
Open "Car Data".
3. Select "Car Data" and press the controller.
4. Select "Limit" and press the controller.



5. Select the speed value and press the controller.
6. Turn the controller to set the limit.
7. Press the controller to apply the setting.
The limit is automatically activated.

Applying your current speed as limit

Select "Select current speed" and press the controller. The system applies your current speed as the limit.

Activating limit

Select "On" and press the controller.

Limit is automatically activated.

Stopwatch

iDrive, for operating principle refer to page 16.

1. Open the start menu.
2. Open "Navigation".
Without navigation system*:
Open "Car Data".
3. Select "Car Data" and press the controller.
4. Select "Stopwatch" and press the controller.



Starting, stopping or resetting

- ▷ Select "Start" and press the controller.
The stopwatch starts at the displayed time.
- ▷ Select "Reset" and press the controller.
The stopwatch is reset and it restarts if it was running beforehand.
- ▷ Select "Stop" and press the controller.
This stops the timer.

Taking an intermediate time reading

Select "Interim time" and press the controller. The interim time appears below the ongoing primary stopwatch count.

All of the remaining functions remain available at all times while the stopwatch is running. The stopwatch continues operation in the background. ◀

Settings on Control Display

iDrive, for operating principle refer to page 16.

1. Press the **MENU** button once or twice until the start menu appears.



2. Press the controller to open the **i** menu.
3. Turn the controller until "Settings" is selected and press the controller.



Setting time

1. Turn the controller until "Time / Date" is selected and press the controller.



2. Move the controller once to the front if necessary to change to the first field from the top.

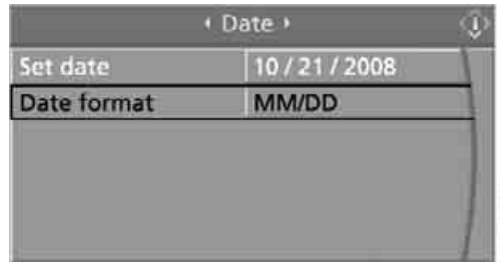

3. Turn the controller until "Time" is selected and press the controller.

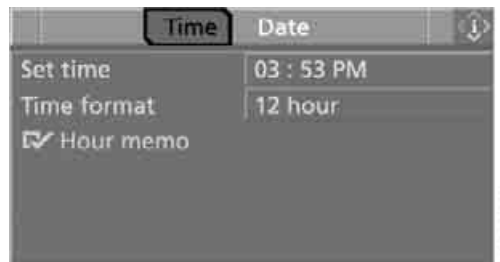

4. Turn the controller until "Set time" is selected and press the controller.

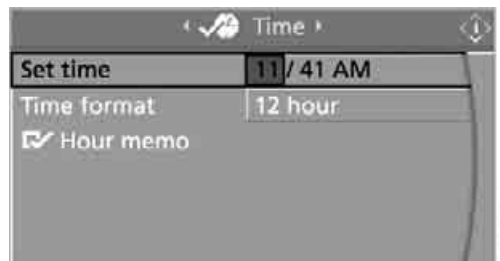

Making settings

1. Turn the controller to set the hours and press the controller.
2. Turn the controller to set the minutes and press the controller.

The changed time is stored.

Switching on hour signal*

You will hear tones just before each full hour. Select "Hour memo" and press the controller.

The hour signal is activated.

The setting is stored for the remote control currently in use.

Setting time format

1. Select "Time format" and press the controller.
2. Select the desired format and press the controller.

The setting is stored for the remote control currently in use.

Setting date

1. Select "Date" and press the controller.



2. Select "Set date" and press the controller. The first section of the date display is highlighted, in this case the month.
3. Turn the controller to make the adjustment.
4. Press the controller to apply the setting. The next setting is highlighted.
5. Make the remaining adjustments. After the last adjustment, the date is stored.

Changing date format

1. Select "Date format" and press the controller.
2. Select the desired format and press the controller.

The setting is stored for the remote control currently in use.

Brightness of Control Display

The brightness is automatically adapted to the ambient lighting conditions. However, you can change the basic setting.

iDrive, for operating principle refer to page 16.

1. Press the **MENU** button. This opens the start menu.
2. Press the controller to open the **i** menu.
3. Select "Settings" and press the controller.
4. Select "Display settings" and press the controller.
5. Change to upper field if necessary. Turn the controller until "Brightness" is selected and press the controller.



6. If necessary, move the controller to the right to select "Display".
7. Turn the controller until the desired setting is selected.

The setting is stored for the remote control currently in use.

Units of measure

You can change the units of measure for consumption, distances, temperature and pressure.

iDrive, for operating principle refer to page 16.

1. Press the **MENU** button. This opens the start menu.
2. Press the controller to open the **i** menu.
3. Select "Settings" and press the controller.
4. Select "Language / Units" and press the controller.

5. Change to upper field if necessary. Turn the controller until "Units" is selected and press the controller.

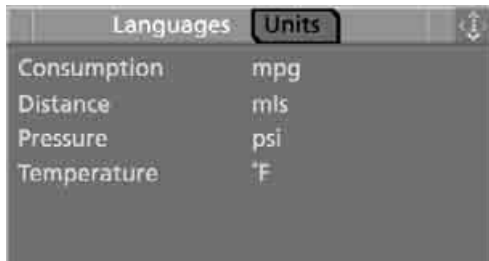

6. Select the menu item to be set and press the controller.
7. Select the desired unit of measure and press the controller.

The settings are stored for the remote control currently in use.

Language on Control Display

iDrive, for operating principle refer to page 16.

1. Press the **MENU** button.
This opens the start menu.
2. Press the controller to open the **i** menu.
3. Select "Settings" and press the controller.
4. Select "Language / Units" and press the controller.
5. Change to upper field if necessary. Turn the controller until "Languages" is selected and press the controller.

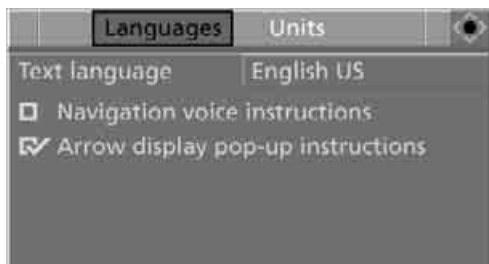

6. Select "Text language" and press the controller. You can change the language of the text displays.
7. Select and activate the desired language by pressing the controller.

The setting is stored for the remote control currently in use.

Volume of warning tones*

On vehicles equipped with a single drive, you can increase or decrease the volume of the warning tones, e.g. for the safety belt reminder, compared to the entertainment sound output. The warning tones have a specified minimum and maximum volume that cannot be dropped below or exceeded.

1. Select "Tone / Volume" and press the controller.
2. Select "Volume settings" and press the controller.



3. Change to the second field from the top if necessary. Select "Warning tones" and press the controller.
4. If necessary, change to the right-hand field and turn the controller.
The setting is applied.

Technology for comfort, convenience and safety

PDC Park Distance Control*

The concept

The PDC assists you when you are parking. Acoustic signals and an optical display* alert you to the approach of an object from behind your vehicle. To measure the distance, there are four ultrasonic sensors in each bumper. The range of these sensors is approx. 7 ft/2 m. However, an acoustic warning first sounds for the sensors at the front and at the two rear corners at approx. 24 in/60 cm, and for the center rear sensors at approx. 5 ft/1.50 m.

 PDC is a parking aid that can indicate objects when they are approached slowly, as is usually the case when parking. Avoid approaching an object at high speed, otherwise the physical circumstances would mean that the system warning was too late. ◀

Automatic activation

Whenever the engine is running or the ignition is on, each time you move the selector lever into position R, the PDC system is activated after approx. 1 second.

Wait this short period before driving off.

Manual activation

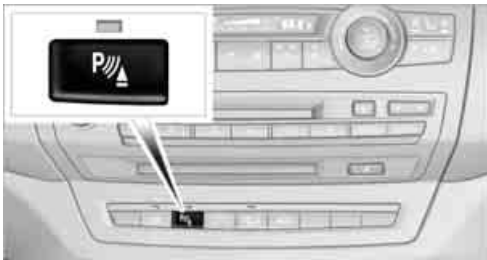

Press the button, the LED lights up.

Manual deactivation

Press the button again; the LED goes out.

Automatic deactivation

After driving approx. 165 ft/50 m or at over approx. 20 mph/30 km/h, the system is switched off and the LED goes out. You can reactivate the system manually as needed.

Signal tones

When nearing an object, the position is correspondingly indicated by an interval tone. Thus, an object detected to the left rear of the vehicle will be indicated by a signal tone from the left rear speaker, etc. As the distance between vehicle and object decreases, the intervals between the tones become shorter. If the distance to the nearest object falls to below roughly 1 ft/30 cm, then a continuous tone sounds.

An intermittent tone is interrupted after approx. 3 seconds:

- ▷ if you remain in front of an object that was only detected by one of the corner sensors
- ▷ if you drive parallel to a wall

Adjusting

You can adjust the volume of the warning tones if the vehicle is equipped with a single drive, refer to page 83.

Malfunction

The LED in the button flashes and a message appears on the Control Display. PDC is malfunctioning. Have the system checked.

To prevent this problem, keep the sensors clean and free of ice or snow in order to ensure that they will continue to operate effectively. Do not spray the sensors with high-pressure cleaners for long periods and maintain a distance of at least 4 in/10 cm to them.

PDC with visual warning*

You can also have the system show distances to objects on the Control Display. Objects that are farther away are already shown there before a signal tone sounds.

The setting is stored for the remote control currently in use.

If the vehicle is equipped with a rear view camera, refer to Displays on page 88.

iDrive, for operating principle refer to page 16.

1. Press the **MENU** button.
This opens the start menu.
2. Press the controller to open the **i** menu.
3. Select "Settings" and press the controller.



4. Select "Vehicle / Tires" and press the controller.
5. Change to upper field if necessary. Turn the controller until "Maneuvering aids" is selected and press the controller.



6. Turn the controller until "View selection" is selected and press the controller.



7. Select "PDC in main window only" and press the controller.
 The PDC screen is activated.

The display appears on the Control Display as soon as PDC is activated.

System limits

 Even with PDC, final responsibility for estimating the distance between the vehicle and any obstructions always remains with the driver. Even when sensors are provided, there is a blind spot in which objects can no longer be detected. The system's detection of objects is also subject to the physical limits that apply to all forms of ultrasonic measurement, such as those encountered with tow bars and trailer couplings, thin or wedge-shaped objects etc. Low objects already displayed, e.g. the curb, can also disappear from the detection area of the sensors again before or after a continuous tone already sounds. Higher, protruding objects, e.g. ledges, cannot be detected. For this reason, drive with care; otherwise, there is a danger of personal injury or property damage.

Loud sources of sound, inside and outside the vehicle, could drown out the PDC signal tone. ◀

Rear view camera*

The concept

The rear view camera in the liftgate displays the area behind your vehicle on the Control Display.

 Also check the traffic situation around the vehicle during parking and maneuvering with direct vision, as otherwise danger of an accident could result, for example, from road users or objects located outside the picture area of the rear view camera. ◀

Switching on

Automatically

With the engine running, shift into reverse.

 If the image of the Park Distance Control PDC appears in the Control Display, you can switch the image to the rear view camera, refer to Displays on page 88. ◀

Manually



Press the button.
PDC is activated at the same time, refer to page 84.

 If the image of the Park Distance Control PDC appears in the Control Display, you can switch the image to the rear view camera, refer to Displays on page 88. ◀

Switching off

Automatically

When driving forward at over approx. 12 mph/ 20 km/h or after driving approx. 164 ft/50 m.

Manually

Press the button again; the LED goes out.

Driver assistance functions

The following functions can improve the effect of the rear view camera depending on the situation.

They can only be activated when the tailgate and liftgate are completely closed.

Pathway lines

The pathway lines are shown in the picture of the rear view camera. They help you to estimate the space required when parking and maneuvering on level roads.

To estimate the space required, turn the steering wheel so that the pathway lines guide into the parking space or the maneuvering area you have chosen.

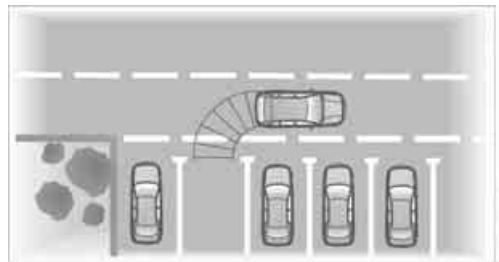

The pathway lines are dependent on the current steering angle and are continuously adjusted to the steering wheel movements.

Turning lines

The static turning lines are displayed in the picture of the rear view camera and show you the course of the smallest possible turning circle on level roads.

Using pathway and turning lines

1. Position the vehicle so that the turning lines guide within the limits of the parking space.

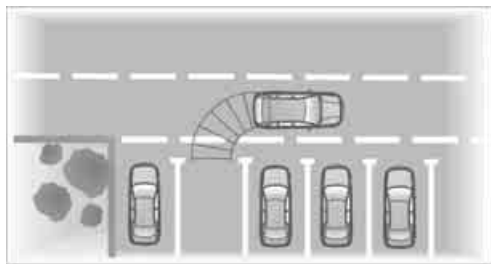

2. Turn the steering wheel so that the pathway lines cover the corresponding turning lines.

This results in a steering wheel position that makes full use of the smallest possible turning circle of the vehicle when parking.

Virtual camera panning

The displayed picture area is dependent on the current speed:

At low speeds, the camera view is panned toward the street, and at higher speeds toward the horizon.

This enables the currently relevant picture area to be shown enlarged on the Control Display.

To activate the virtual camera panning, select the camera view "Camera view: full screen", refer to Displays on page 88.

Obstacle marking

Spatially shaped markings are shown in the picture of the rear view camera. Their stepped colors correspond to the markings of the Park Distance Control and support you in estimating the distance to the object shown.

The obstacle marking is deactivated when driving in reverse from approx. 12 mph/20 km/h.

Activating driver assistance functions

The driver assistance functions can be active at the same time. The zoom function for trailer towing can only be activated individually with the rear view camera switched on.

With rear view camera switched on

iDrive, for operating principle refer to page 16.

1. Press the controller.
2. Select the desired function and press the controller.

You can also adjust the brightness of the camera view.

With rear view camera switched off

1. Press the **MENU** button.
This opens the start menu.
2. Press the controller to open the **i** menu.
3. Select "Settings" and press the controller.
4. Select "Vehicle / Tires" and press the controller.
5. Change to upper field if necessary. Turn the controller until "Maneuvering aids" is selected and press the controller.



6. Select "Settings" and press the controller.



7. Select the desired functions and press the controller.

The settings are stored for the remote control currently in use.

Displays

You can have the picture from the rear view camera displayed in several formats and in combination with the PDC Park Distance Control, refer to page 85.

In addition, you also have the option of displaying only the PDC Park Distance Control.

- ▷ "Camera picture and PDC"
The rear view camera picture is shown in the main window of the Control Display.
- ▷ "Camera view: full screen"
The picture of the rear view camera is shown on the entire Control Display.
- ▷ "Camera view: main window"
The picture of the rear view camera is shown in the main window of the Control Display.
- ▷ "PDC in main window only"
PDC is shown in the main window of the Control Display.

Selecting displays

1. Select "Maneuvering aids" and press the controller, refer to Driver assistance functions.
2. Turn the controller until "View selection" is selected and press the controller.



3. Select the desired display and press the controller.

The setting is stored for the remote control currently in use.

Setting brightness

You can set the brightness of the camera view with the rear view camera switched on.

iDrive, for operating principle refer to page 16.

1. Press the controller.
2. Turn the controller until "Brightness" is selected and press the controller.
3. Set the desired brightness.

Cleaning rear view camera



The lens of the rear view camera is located on the liftgate.

The picture quality of the rear view camera may be impaired by dirt. Clean the lens with a moist, non-abrasive cloth.

The lens is automatically heated in case of frost.

Driving stability control systems

Your BMW is equipped with an extended array of systems designed to enhance and maintain vehicle stability under extreme conditions.

ABS Antilock Brake System

ABS prevents locking of the wheels during braking. Safe steering response is maintained even during full braking. Active safety is thus increased.

ABS is operational every time you start the engine. Braking safely, refer to page 129.

CBC Cornering Brake Control

When braking during curves or when braking during a lane change, driving stability and steering response are improved further.

Electronic brake-force distribution

The system controls the brake pressure in the rear wheels to ensure stable braking behavior.

Brake assistant

When you apply the brakes rapidly, this system automatically produces the maximum braking force boost and thus helps to achieve the shortest possible braking distance during full braking. This system exploits all of the benefits provided by ABS.

Do not reduce the pressure on the brake pedal for the duration of the full braking.

DSC Dynamic Stability Control

DSC prevents traction loss in the driving wheels when starting off and accelerating. The system also identifies unstable driving conditions, such as a loss of traction at the rear of the vehicle or sliding of the vehicle in its front wheels. In these cases, DSC helps the vehicle maintain a safe course within physical limits by reducing engine output and through braking actions in the individual wheels.

 The laws of physics cannot be repealed, even with DSC. An appropriate driving style remains the responsibility of the driver. Therefore, do not restrict the additional safety margin with a risky driving style, as otherwise there is a risk of an accident. ◀

Deactivating DSC

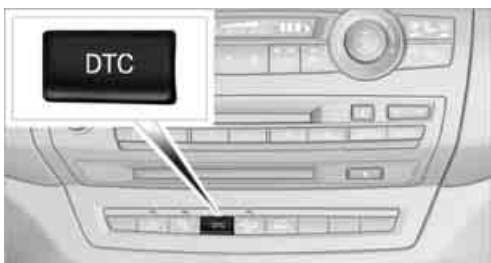

Press the button until the DSC indicator lamp in the instrument panel lights up, but not longer than approx. 10 seconds. DTC Dynamic Traction Control and DSC are deactivated together. Stabilizing interventions are now not carried out.

A message appears on the Control Display. Please note any supplementary information that appears there.

To increase vehicle stability, activate DSC again as soon as possible.

Activating DSC

Press the button; the indicator lamp in the instrument panel goes out.

For better control



The indicator lamp flashes: DSC controls the drive forces and brake forces.



The indicator lamps light up: DSC is deactivated.

DTC Dynamic Traction Control

DTC is a version of DSC in which the drive output is optimized for particular road conditions, e.g. unplowed snow-covered roads. The system assures the maximal drive output, but with reduced driving stability. It is therefore necessary to drive with appropriate caution.

You may find it useful to briefly activate DTC under the following special circumstances:

- ▶ When driving in sand, on snowy inclines, in slush or on unplowed, snow-covered road surfaces
- ▶ When rocking a stuck vehicle free or starting off in deep snow, sand or on loose ground
- ▶ When driving with snow chains*

Activating DTC



Press the button briefly; the DTC indicator lamp in the instrument panel lights up.

For better control



The indicator lamp flashes:
DTC controls the drive forces and brake forces.

DTC



The indicator lamps light up:
DTC is activated.

Deactivating DTC

Press the button again; the DTC indicator lamp in the instrument panel goes out.

xDrive

xDrive is the 4-wheel drive system of your X5. The combined effects of xDrive and DSC further optimize the traction and dynamic driving characteristics. The 4-wheel drive system xDrive variably distributes the drive forces to the front and rear axle depending on the driving situation and prevailing road conditions.

HDC Hill Descent Control

The concept

HDC is a system for driving downhill in steep terrain. This system reduces vehicle speed on steep downhill gradients, thus allowing you to maintain even better control of your BMW under these conditions. The vehicle moves at approximately walking speed without active intervention from the driver.

HDC is available for activation at vehicle speeds below approx. 22 mph/35 km/h. When driving down steep hills with a speed below approx. 22 mph/35 km/h, the vehicle reduces speed automatically down to approximately walking speed, approx. 5 mph/8 km/h, and then maintains this speed at a constant.

Only use HDC in transmission positions D or R.

Increasing or reducing speed

You can use the accelerator or brakes to vary this automatically controlled speed within a range extending from approx. 4 mph/6 km/h to 15 mph/25 km/h.

You can specify a target speed within the same range by using the lever of the cruise control.

With downhill grade over 10% you can reduce the speed to approx. 3 mph/4 km/h. Pull the lever of the cruise control beyond the resistance point, arrow **3**.

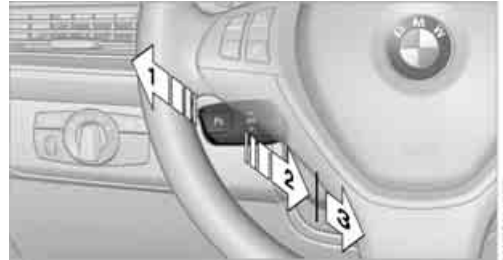

- 1 Increasing speed
- 2 Pull to the resistance point:
Reduce speed to approx. 4 mph/6 km/h
- 3 Pull beyond the resistance point:
With downhill grade over 10%, reduce speed to approx. 3 mph/4 km/h.

Activating HDC



Press the button; the LED lights up. The HDC display is shown in the instrument panel.

The LED flashes when the brakes are applied automatically.

Deactivating HDC

Press the button again. The LED and the HDC display go out.

HDC is also deactivated at speeds over approx. 37 mph/60 km/h.

Displays* in instrument panel



- 1 Display for target speed
- 2 HDC display

Malfunction

HDC is temporarily unavailable in the following situations due to a high brake temperature:

- ▶ The LED in the button and the display HDC go out during HDC operation.
- ▶ The LED in the button and the HDC display do not light up when the button is pressed.

Malfunction of driving stability control systems

 When driving on poor roads, avoid using full throttle or pressing the accelerator beyond the kick-down point and also avoid heavy braking. Otherwise, the drive train may be damaged or accidents can occur. ◀

Adaptive Drive*

The concept

Adaptive Drive reduces the body roll which occurs when cornering quickly or during fast evasive maneuvers. In addition, Adaptive Drive also reduces the steering angle requirement, improves the running comfort and increases the dynamic driving characteristics of your X5.

Chassis and suspension tuning

You can choose between two types of chassis and suspension tuning.

- ▶ **Normal:**
The comfortable basic setting offers optimum comfort when traveling.
- ▶ **Sport:**
The sporty basic setting offers increased driving agility.

Selecting chassis and suspension tuning



Press the button.

The system switches between the two chassis and suspension tuning settings.

- ▶ **Sport:**
The LED in the button lights up and SPORT is displayed in the instrument panel.
- ▶ **Normal:**
The LED in the button goes out.

The selection of the chassis and suspension tuning setting is stored for the remote control currently in use.

Starting assistant

The starting assistant enables you to start off conveniently on slopes. The parking brake is not required for this purpose.

1. Hold the vehicle with the footbrake.
2. Release the footbrake and immediately drive off quickly.

 The starting assistant holds the vehicle for approx. 2 seconds after releasing the footbrake. Depending on the load, the vehicle may also roll back slightly during this time. After releasing the footbrake, immediately start quickly, otherwise the starting assistant no

longer holds the vehicle after approx. 2 seconds and it begins to roll back. ◀

Self-leveling suspension*

Malfunction



The warning lamp for self-leveling suspension lights up yellow and a message is shown on the Control

Display. A malfunction has occurred in the self-leveling suspension. Stop and check the vehicle. If it is considerably lower at the rear than at the front, and possibly also on one side – rear left compared to rear right –, proceed to the nearest BMW Sports Activity Vehicle Center or a workshop that works according to BMW repair procedures with correspondingly trained personnel. Drive with appropriate caution in the meantime. The vehicle has reduced ground clearance and driving comfort may be noticeably reduced. Even if the orientation of the vehicle is normal, when a malfunction is indicated on the display, you should proceed to the nearest BMW Sports Activity Vehicle Center or a workshop that works according to BMW guidelines and uses appropriately trained personnel.

FTM Flat Tire Monitor*

The concept

The Flat Tire Monitor detects a pressure loss in one tire by comparing the speeds of the individual wheels during driving.

In the event of a pressure loss, there is a change in the rolling circumference and therefore the rotation speed of the corresponding wheel. The system detects this change and reports it as a flat tire.

Function requirements

In order to assure the reliable reporting of a flat tire, the system must be initialized for the correct tire inflation pressure.



The initialization must be repeated after each time the tire inflation pressure is corrected and after every tire or wheel change. ◀

System limits



The Flat Tire Monitor cannot indicate sudden severe tire damage caused by outside factors and does not detect a natural, even pressure drop in all four tires. ◀

In the following situations, the system could be delayed or malfunction:

- ▷ System has not been initialized
- ▷ Driving on snowy or slippery road surface
- ▷ Sporty driving style: slip in the drive wheels, high lateral acceleration
- ▷ Driving with snow chains*

When you are driving with the compact wheel* the Flat Tire Monitor is unable to function.

Initializing system



The initialization finishes during driving, which can be interrupted at any time. When driving resumes, the initialization is continued automatically. Do not initialize the system when driving with snow chains* or with the compact wheel*. ◀

iDrive, for operating principle refer to page 16.

1. Press the **MENU** button.
This opens the start menu.
2. Press the controller to open the **i** menu.
3. Select "Settings" and press the controller.



4. Select "Vehicle / Tires" and press the controller.

- Change to upper field if necessary. Turn the controller until "FTM" is selected and press the controller.

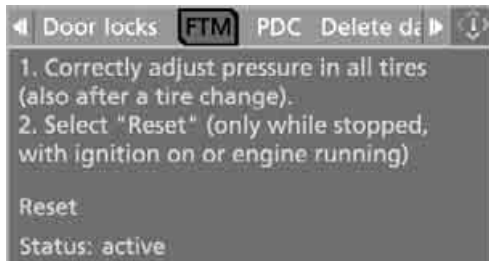

- Start the engine, but do not start driving.
- Select "Reset" and press the controller.
- Select "Yes" and press the controller. The message "resetting FTM ..." is displayed.



- Start to drive. The initialization finishes during driving.

Indication of a flat tire

 The warning lamp lights up red. A message appears on the Control Display. In addition, an acoustic signal sounds. There is a flat tire or extensive inflation pressure loss.

If you have deactivated DSC, it will be activated automatically.

- Cautiously reduce speed to below 50 mph/80 km/h. Avoid sudden braking and steering maneuvers. Do not exceed a speed of 50 mph/80 km/h. In case of further air loss of the defective wheel, its position will be indicated to you on the Control Display.

 If the vehicle is not equipped with run-flat tires as provided at the factory, refer to page 239, do not continue driving. Continuing to drive with a flat tire could cause severe accidents. ◀

- At the next opportunity, check the air pressure in all four tires.

 If the tire inflation pressure in all four tires is correct, the Flat Tire Monitor may not have been initialized. The system must then be initialized. ◀

- In the event of complete tire pressure loss, 0 psi/0 kPa, you can estimate the possible distance for continued driving on the basis of the following guide values:

- ▶ With a light load:
1 to 2 persons without luggage:
approx. 155 miles/250 km
- ▶ With a medium load:
2 persons, cargo bay full, or
4 persons without luggage:
approx. 95 miles/150 km
- ▶ With a full load:
4 or more persons, cargo bay full:
approx. 30 miles/50 km

 Drive cautiously and do not exceed speeds of 50 mph/80 km/h or else you run the risk of causing an accident. In the event of pressure loss, vehicle handling changes. This includes reduced tracking stability in braking, extended braking distance and altered natural steering characteristics.

If unusual vibrations or loud noises occur while the vehicle is being driven, this can indicate final failure of the damaged tire. Reduce speed and stop at a suitable location as soon as possible, otherwise pieces of the tire could become detached and cause an accident. Do not continue driving, but instead contact the BMW Sports Activity Vehicle Center. ◀

TPM Tire Pressure Monitor*

The concept

TPM checks the tire inflation pressure in the four mounted tires. The system reports when the tire inflation pressure has dropped considerably in one or several tires.

Function requirements

In order to assure the reliable reporting of a flat tire, the system must have been reset with the correct tire inflation pressure.

Always use wheels with TPM electronics, otherwise fault-free operation of the system is not ensured.

 Reset the system again after each correction of the tire inflation pressure and after every tire or wheel change. ◀

System limits

 TPM cannot announce sudden serious tire damage caused by external influences. ◀

The system does not function properly if it has not been reset, e.g. a flat tire is reported despite correct tire inflation pressures.

The system is inactive and cannot display a flat tire if a wheel has been mounted without TPM electronics, e.g. a compact wheel*, or if TPM is temporarily interfered with by other systems or devices which use the same radio frequency.

Status display on Control Display

The tire and system status is indicated by the color of the tires.

TPM takes the fact that the tire pressure changes during driving into account. A correction is only required if requested by TPM with the color.

Green

The tire pressure matches the learned set state. "TPM active" is displayed on the Control Display.

One wheel is yellow

Flat tire or a major drop in inflation pressure in the indicated tire. A message appears on the Control Display.

All wheels are yellow

Flat tire or a major drop in inflation pressure in several tires. A message appears on the Control Display.

Gray

The system cannot detect a flat tire.

Reasons for this can be:

- ▷ TPM is being reset
- ▷ Temporary interference due to systems or devices which use the same radio frequency
- ▷ Malfunction

Resetting system

 Reset the system again after each correction of the tire inflation pressure and after every tire or wheel change. ◀

Resetting finishes during driving, which can be interrupted at any time. When driving resumes, resetting is continued automatically. Do not reset the system when driving with a compact wheel*.

iDrive, for operating principle refer to page 16.

1. Press the **MENU** button.
This opens the start menu.
2. Press the controller to open the **i** menu.
3. Select "Settings" and press the controller.



4. Select "Vehicle / Tires" and press the controller.

- Change to upper field if necessary. Turn the controller until "TPM" is selected and press the controller.



- Start the engine, but do not start driving.
- Select "Reset" and press the controller.
- Select "Yes" and press the controller.



- Start to drive.
The tires are shown in gray and "Resetting TPM..." is displayed.

After a few minutes of driving, the set tire inflation pressures in the tires are applied as the set values to be monitored. Resetting finishes during driving. The tires are shown in green on the Control Display.

-  If a flat tire is detected during resetting and applying the tire inflation pressures, all tires are shown in yellow on the Control Display. The message "Tire low!" is displayed. ◀

Message with low tire inflation pressure

 The warning lamp lights up yellow. A message appears on the Control Display. In addition, an acoustic signal sounds. There is a flat tire or extensive inflation pressure loss.

- Cautiously reduce speed to below 50 mph/ 80 km/h. Avoid sudden braking and steering maneuvers. Do not exceed a speed of 50 mph/80 km/h.



If the vehicle is not equipped with run-flat tires as provided at the factory, refer to page 239, do not continue driving. Continuing to drive with a flat tire could cause severe accidents. ◀

- In the event of complete tire pressure loss, 0 psi/0 kPa, you can estimate the possible distance for continued driving on the basis of the following guide values:

- ▶ With a light load:
1 to 2 persons without luggage:
approx. 155 miles/250 km
- ▶ With a medium load:
2 persons, cargo bay full, or
4 persons without luggage:
approx. 95 miles/150 km
- ▶ With a full load:
4 or more persons, cargo bay full:
approx. 30 miles/50 km



Drive cautiously and do not exceed speeds of 50 mph/80 km/h or else you run the risk of causing an accident. In the event of pressure loss, vehicle handling changes. This includes reduced tracking stability in braking, extended braking distance and altered natural steering characteristics.

If unusual vibrations or loud noises occur while the vehicle is being driven, this can indicate final failure of the damaged tire. Reduce speed and stop at a suitable location as soon as possible, otherwise pieces of the tire could become detached and cause an accident. Do not continue driving, but instead contact the BMW Sports Activity Vehicle Center. ◀

Malfunction



The yellow warning lamp flashes and then lights up continuously. The tires are shown in gray on the Control Display and a message is displayed. No flat tire can be detected.

A message like this is displayed in the following situations:

- ▷ In case of a malfunction:
Have the system checked
- ▷ If a wheel without TPM electronics is mounted, e.g. a compact wheel*
- ▷ If TPM is temporarily interfered with by other systems or devices which use the same radio frequency

Explanation according to the NHTSA/ FMVSS 138 Tire Pressure Monitoring Systems

Each tire, including the spare*, should be checked monthly when cold and inflated to the inflation pressure recommended by the vehicle manufacturer on the vehicle placard or tire inflation pressure label. If your vehicle has tires of a different size than the size indicated on the vehicle placard or tire inflation pressure label, you should determine the proper tire inflation pressure for those tires. As an added safety feature, your vehicle has been equipped with a tire pressure monitoring system, TPMS, that illuminates a low tire pressure telltale when one or more of your tires are significantly under-inflated. Accordingly, when the low tire pressure telltale illuminates, you should stop and check your tires as soon as possible, and inflate them to the proper pressure. Driving on a significantly underinflated tire causes the tire to overheat and can lead to tire failure. Under-inflation also reduces fuel efficiency and tire tread life, and may affect the vehicle's handling and stopping ability. Please note that the TPMS is not a substitute for proper tire maintenance, and it is the driver's responsibility to maintain correct tire pressure, even if under-inflation has not reached the level to trigger illumination of the TPMS low tire pressure telltale.

The TPMS malfunction indicator is combined with the low tire pressure telltale. When the system detects a malfunction, the telltale will flash for approximately one minute and then remain continuously illuminated. This sequence will continue upon subsequent vehicle startups as long as the malfunction exists. When the mal-

function indicator is illuminated, the system may not be able to detect or signal low tire pressure as intended. TPMS malfunctions may occur for a variety of reasons, including the installation of replacement or alternate tires or wheels on the vehicle that prevent the TPMS from functioning properly. Always check the TPMS malfunction telltale after replacing one or more tires or wheels on your vehicle to ensure that the replacement or alternate tires and wheels allow the TPMS to continue to function properly.

Active steering*

The concept

The active steering actively varies the steering angle of the front wheels in relation to the steering wheel movements. In addition, it also varies the steering force required for steering depending on the vehicle's speed.

When you are driving in the low road speed range, e.g. in a town or when parking, the steering angle increases, i.e. the steering becomes very direct. In the higher speed range, on the other hand, the steering angle is reduced more and more. This improves the handling capability of your BMW over the entire speed range.

In critical situations, the system can make targeted corrections to the steering angle provided by the driver and thus stabilize the vehicle before the driver intervenes.

Malfunction



The warning lamp lights up yellow and a message is shown on the Control Display. The active steering is no longer operational. At low speeds, greater steering wheel movements are required, whereas at higher speeds, the vehicle reacts more sensitively to steering wheel movements. The stability-promoting intervention can also be deactivated. Proceed cautiously and drive defensively. Have the system checked.

Brake force display



On the left: normal braking.

On the right: heavy braking.

Airbags



The following airbags are located under the marked covers:

- 1 Front airbags
- 2 Head airbags
- 3 Side airbags in backrests

Protective action

 To ensure that the safety systems continue to provide optimized protection, please observe the adjustment instructions on page 42. ◀

The front airbags help protect the driver and front passenger by responding to frontal impacts in which safety belts alone cannot provide adequate restraint. When needed, the head and side airbags help provide protection in the event of side impact. The relevant side airbag supports the side upper body area. The head air bag supports the head.

The airbags are deliberately not triggered in every impact situation, e.g. less severe accidents or rear-end collisions.

 Do not apply adhesive materials to the cover panels of the airbags, cover them or modify them in any other way. Do not attempt to remove the airbag restraint system from the vehicle. Do not modify or tamper with either the wiring or the individual components in the airbag system. This category includes the upholstery in the center of the steering wheel, on the instrument panel, the doors and the roof pillars along with the sides of the headliner. Do not attempt to remove or dismantle the steering wheel. Do not touch the individual components immediately after the system has been triggered, because there is a danger of burns. In the event of malfunctions, deactivation, or triggering of the airbag restraint system, have the testing, repair, removal, and disposal of airbag generators executed only by a BMW Sports

Activity Vehicle Center or a workshop that works according to BMW repair procedures with correspondingly trained personnel and has the required explosives licenses. Otherwise unprofessional attempts to service the system could lead to failure in an emergency or undesired airbag triggering, either of which could result in personal injury. ◀

Warnings and information on the airbags is also provided on the sun visors.

Automatic deactivation of front passenger airbags

The occupation of the seat is detected by evaluating the impression on the occupied seat surface of the front passenger seat. The front and side airbags on the front passenger side are activated or deactivated accordingly by the system.

▷ The current status of the front passenger airbag, i.e. deactivated or activated, is indicated by the indicator lamp over the interior rearview mirror, refer to Operating state of front passenger airbags in the following. ◀

⚠ Before transporting a child on the front passenger seat, read the safety information and follow the instructions under Transporting children safely, refer to page 55. When teenagers and adults assume certain sitting positions, this can cause the front and side airbags to deactivate. The indicator lamp for the front passenger airbags lights up when this occurs. In these cases, change the sitting position so that the front passenger airbags are activated and the indicator lamp goes out. If the desired status cannot be produced by changing the sitting position, transport the corresponding person on the rear seat. Do not fit seat covers, seat cushion padding, ball mats or other items onto the front passenger seat unless they are specifically recommended by BMW. Do not lay objects under the seat which could press against the seat from below. Otherwise a correct evaluation of the occupied seat surface cannot be ensured. ◀

Operating state of front passenger airbags

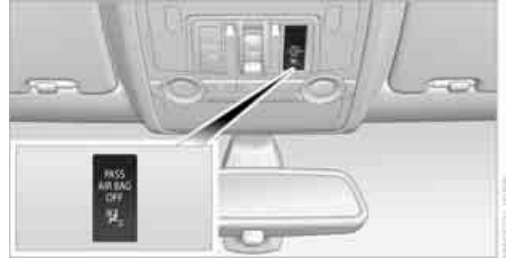

Depending on the vehicle's equipment, the arrangement of the switches and indicator lamps may differ somewhat.

The indicator lamp for the front passenger airbags indicates the operating status of the front and side airbags on the front passenger side depending on the seat occupation. The indicator lamp shows whether the front passenger airbags are activated or deactivated.

- ▷ The indicator lamp lights up when a child in a child restraint system intended for the purpose is properly detected on the seat. The front and side airbags on the front passenger side are not activated.
- ▷ Most child's seats are detected by the system. Especially the child's seats required by the NHTSA at the time the vehicle is manufactured. After installing a child's seat, make sure that the indicator lamp for the front passenger airbags lights up. This indicates that the child's seat has been detected and the front passenger airbags are not activated. ◀
- ▷ The indicator lamp does not light up when, for example, a correctly seated person of sufficient height is detected on the seat. The front and side airbags on the front passenger side are activated.
- ▷ The indicator lamp does not light up when the seat is empty. However, the front and side airbags on the front passenger side are not activated.

Operational readiness of airbag system



From radio readiness, refer to page 59, the warning lamp lights up briefly, indicating the operational readiness of the entire airbag system and the safety belt tensioners.

Airbag system malfunction

- ▶ Warning lamp does not light up from radio readiness.
- ▶ Warning lamp lights up continuously.

 Have the airbag system checked immediately in case of a malfunction, otherwise there is a danger that the airbag system may not respond in the expected manner in an accident despite an impact of corresponding intensity. ◀

Head-Up Display*

The concept

With the Head-Up Display important information is projected into the driver's field of view, e.g. navigation instructions. This enables you to take in this information without looking away from the road.



Switching on/off

Press the button.



- 1 Navigation information or Check Control messages
- 2 Cruise control
- 3 Speed

Selecting displays

iDrive, for operating principle refer to page 16.

1. Press the **MENU** button.
This opens the start menu.
2. Press the controller to open the **i** menu.
3. Select "Settings" and press the controller.
4. Select "Display settings" and press the controller.

5. Change to upper field if necessary. Turn the controller until "Head-Up Display" is selected and press the controller.
6. Change into the second field from the top. Turn the controller until "Head-Up Display" is selected and press the controller.
7. Select desired information of Head-Up Display.



8. Press the controller.
 - The information is shown on the Head-Up Display.

The settings are stored for the remote control currently in use.

Adjusting brightness and height of display

The brightness of the display is automatically adapted to the ambient lighting conditions. However, you can change the base setting. With the low beams switched on, the brightness can also be adjusted with the knurled wheel of the instrument lighting.

iDrive, for operating principle refer to page 16.

1. Press the **MENU** button. This opens the start menu.
2. Press the controller to open the **i** menu.
3. Select "Settings" and press the controller.
4. Select "Display settings" and press the controller.
5. Change to upper field if necessary. Turn the controller until "Head-Up Display" is selected and press the controller.

6. Change into the second field from the top. Turn the controller until "Brightness / Position" is selected and press the controller.



7. If necessary, move the controller to the left or right to select "Brightness" or "Display position".
8. Turn the controller until the desired setting is selected.

The setting is stored for the remote control currently in use.

Notes

The visibility of the displays in the Head-Up Display is influenced by:

- ▷ Sunglasses with certain polarization filters
- ▷ Certain sitting positions
- ▷ Objects on the cover of the Head-Up Display
- ▷ Wet road surface and unfavorable lighting conditions

If the image is distorted, have the basic setting checked at a BMW Sports Activity Vehicle Center.

Special windshield

The windshield is part of the system. The shape of the windshield complies with the requirements of the Head-Up Display to enable a precise display. A film in the windshield prevents the double images from being displayed.

Windshield replacement should be carried out by a BMW Sports Activity Vehicle Center or a workshop that works according to BMW repair procedures with correspondingly trained personnel.

Care instructions

You can find everything you need to know on this topic by consulting the separate Caring for your vehicle brochure.



Only clean the cover of the Head-Up Display with a soft, lint-free cloth or with a display cleaning cloth, otherwise damage may result. ◀

Lamps

Parking lamps/low beams

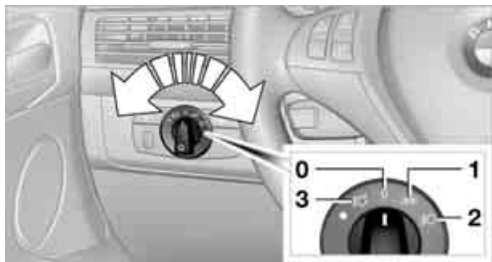

- 0 Lights off and daytime running lamps*
- 1 Parking lamps and daytime running lamps*
- 2 Low beams and welcome lamps
- 3 Automatic headlamp control*, daytime running lamps*, welcome lamps and Adaptive Head Light*

If you open the driver's door with the ignition switched off, the exterior lighting is automatically switched off when the light switch is in position **0**, **2** or **3**.

If necessary, switch on the parking lamps, switch position **1**.

Parking lamps

In switch position **1**, the front, rear and side vehicle lighting is switched on. You can use the parking lamps for parking.

 The parking lamps drain the battery. Do not leave them switched on for long periods of time, otherwise it may no longer be possible to start the engine. It is better to switch on the roadside parking lamps on one side, refer to page [104](#). ◀

Low beams

The low beams light up when the light switch is in position **2** and the ignition is on.

Automatic headlamp control*

In switch position **3**, the system activates the low beams and switches them on or off in response to changes in ambient light conditions, for instance, in a tunnel, at dawn and dusk and in case of precipitation. Adaptive Head Light* is active. The LED next to the symbol lights up when the low beams are on. You can activate the daytime running lamps, refer to page [103](#). In the situations named above, the system then automatically switches over to the low beams.

A blue sky with the sun low on the horizon can cause the lights to be switched on.

 The low beams remain switched on independent of the ambient lighting conditions when you switch on the fog lamps*. ◀

 The automatic headlamp control cannot serve as a substitute for your personal judgment in determining when the lamps should be switched on in response to ambient lighting conditions. For example, the sensors cannot detect fog or hazy weather. To avoid safety risks, you should always switch on the low beams manually under these conditions. ◀

Welcome lamps

If, when parking the vehicle, you leave the light switch in position **2** or **3**, the parking lamps and the interior lamps light up briefly when the vehicle is unlocked.

Activating/deactivating welcome lamps

iDrive, for operating principle refer to page [16](#).

1. Press the **MENU** button.
This opens the start menu.
2. Press the controller to open the **i** menu.
3. Select "Settings" and press the controller.
4. Select "Vehicle / Tires" and press the controller.

5. Change to upper field if necessary. Turn the controller until "Lighting" is selected and press the controller.



6. Select "Welcome light" and press the controller.

The welcome lamps are switched on.

The setting is stored for the remote control currently in use.

Pathway lighting

When you activate the headlamp flasher after parking the vehicle and switching off the lamps, the low beams will come on for a brief period. You can set the duration or deactivate the function via iDrive.

iDrive, for operating principle refer to page 16.

1. Press the **MENU** button.
This opens the start menu.
2. Press the controller to open the **i** menu.
3. Select "Settings" and press the controller.
4. Select "Vehicle / Tires" and press the controller.
5. Change to upper field if necessary. Turn the controller until "Lighting" is selected and press the controller.



6. Select "Pathway lighting" and press the controller.
7. Turn the controller to select the desired duration.
8. Press the controller to apply the setting.

The setting is stored for the remote control currently in use.

Daytime running lamps*

The daytime running lamps light up in position **0**, **1** and **3**. If the light switch remains in position **1**, the parking lamps light up after the ignition is switched off.

Activating/deactivating daytime running lamps*

iDrive, for operating principle refer to page 16.

1. Press the **MENU** button.
This opens the start menu.
2. Press the controller to open the **i** menu.
3. Select "Settings" and press the controller.
4. Select "Vehicle / Tires" and press the controller.
5. Change to upper field if necessary. Turn the controller until "Lighting" is selected and press the controller.



6. Select "Daytime running lamps" and press the controller.

Daytime running lamps are switched on.

The setting is stored for the remote control currently in use.

Adaptive Head Light*

The concept

Adaptive Head Light is a variable headlamp control system that enables better illumination of the road surface. Depending on the steering angle and other parameters, the light from the headlamp follows the course of the road.

In tight curves, e.g. serpentines, or when turning, one of the two front fog lamps is also switched on up to a speed of approx. 45 mph/ 70 km/h. This provides improved illumination of the area inside the curve.

Activating Adaptive Head Light

With the ignition switched on, turn the light switch into the automatic headlamp control position, refer to page 102.

The turning lamps are automatically switched on depending on the steering angle or the use of turn signals.

To avoid blinding oncoming traffic, the Adaptive Head Light directs light towards the front passenger side when the vehicle is at a standstill. When driving in reverse, both turning lamps are active.

Malfunction

The LED next to the symbol for automatic headlamp control flashes. Adaptive Head Light is malfunctioning or has failed. Have the system checked as soon as possible.

High beams/ roadside parking lamps

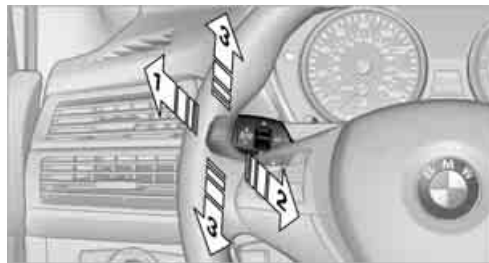

- 1 High beams
- 2 Headlamp flasher
- 3 Roadside parking lamps

Roadside parking lamps, left or right*

You also enjoy the option of lighting up just one side of your vehicle when parking.

Switching on

After parking the vehicle, press the lever up or down beyond the resistance point, arrow **3**.



The roadside parking lamps drain the battery. Do not leave them switched on for long periods of time, otherwise it may no longer be possible to start the engine. ◀

Switching off

Briefly press the lever in the opposite direction up to the resistance point, arrow **3**.

Fog lamps*



The parking lamps or low beams must be switched on for the fog lamps to operate. The green indicator lamp in the instrument panel lights up whenever the fog lamps are on.

▶ If the automatic headlamp control is activated, the low beams will come on automatically when you switch on the fog lamps. ◀

Instrument lighting



You can control the lighting intensity by using the knurled wheel.

Interior lamps

The interior lamps, footwell lamps*, door entry lighting*, cargo bay lamps, and the courtesy lamps* are controlled automatically.

With the courtesy lamps, LED lights are located in the door handles to illuminate the exterior area before the doors.

▶ To protect the battery, all lamps in the vehicle are switched off approx. 15 minutes after radio readiness is switched off, refer to Start/Stop button on page 59. ◀

Switching interior lamps on and off manually

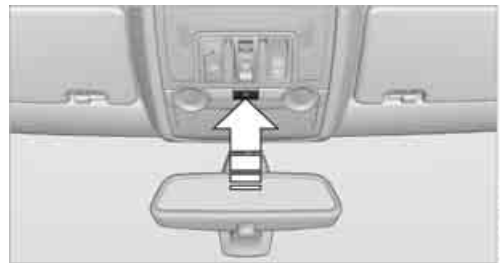

Press the button.

If the interior lamps, footwell lamps, door entry lighting and courtesy lamps are to remain switched off continually, press the button for approx. 3 seconds.

Reading lamps

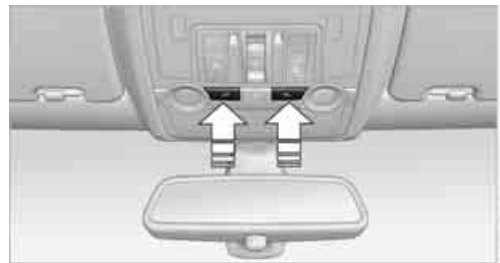

Reading lamps are provided in the front and rear* adjacent to the interior lamps. Press the button to switch the lamps on and off.

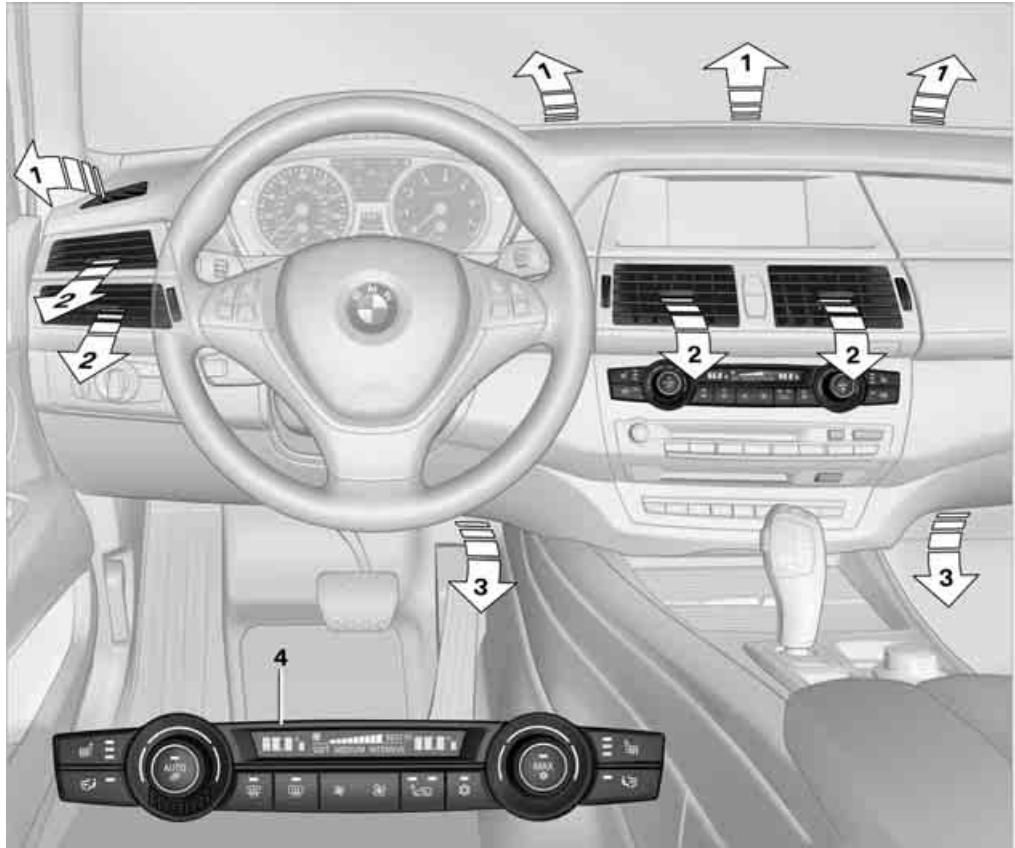

- 1 Air toward the windshield and side windows
- 2 Air for the upper body region, refer to Front ventilation on page 110
- 3 Air to footwell
- 4 Automatic climate control

Automatic climate control

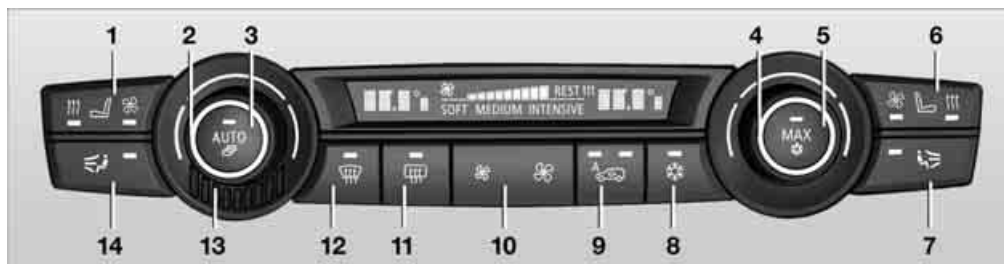

- 1 Seat heating and ventilation, driver's side 50
- 2 Temperature, left side of passenger compartment
- 3 AUTO program
- 4 Temperature, right side of passenger compartment
- 5 Maximum cooling
- 6 Seat heating and ventilation, front passenger side 50
- 7 Manual air distribution, front passenger side
- 8 Switching cooling function on and off manually

- 9 AUC Automatic recirculated-air control/ recirculated-air mode
 - 10 Manual air volume, switching off automatic climate control, residual heat
 - 11 Rear window defroster
 - 12 Defrosting windows and removing condensation
 - 13 Air grill for interior temperature sensor – please keep clear and unobstructed
 - 14 Manual air distribution, driver's side
- The current setting for manual air distribution is displayed on the Control Display.

A congenial climate

The AUTO program offers the optimum air distribution and air volume for virtually all conditions, refer to AUTO program below. Now you only need to select an interior temperature pleasant to you.

The following sections contain more detailed information on the available setting options.

Most settings are stored for the remote control currently in use, also refer to Personal Profile settings on page 28.

AUTO program



The AUTO program handles the adjustment of air volume and air distribution to the windshield and side windows, in the direction of the upper body and in the footwell.

It also adapts your instructions for the temperature to outside influences throughout the year.

The cooling is switched on automatically with the AUTO program. At the same time, a condensation sensor controls the program in such a way that window condensation is prevented as much as possible.

Intensity of AUTO program

You can adjust the intensity of the AUTO program by repeatedly pressing the AUTO button. The respective current setting is displayed when the button on the display of the automatic climate control is pressed.

You can also adjust the intensity of the AUTO program via iDrive.

iDrive, for operating principle refer to page 16.

- 1. Press the **MENU** button. This opens the start menu.
- 2. Move the controller to the left to open "Climate".

3. Select "Automatic programs" and press the controller.

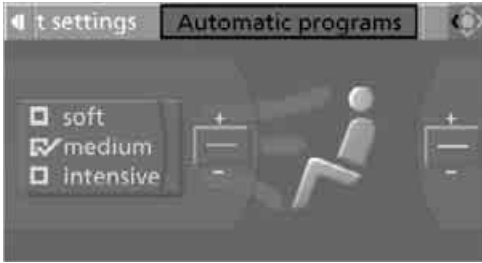

4. Select the desired intensity and press the controller.
 - ✓ The selected intensity level of the automatic program is switched on.

Temperature



Set the desired temperature individually on the driver's and front passenger side.

The automatic climate control adjusts this temperature as quickly as possible at any time of year, if necessary with the maximum cooling or heating capacity, and then keeps it constant.

In the highest setting you activate the maximum heating capacity, regardless of the outside temperature. And in the lowest setting, the maximum cooling capacity.

▶ When switching between different temperature settings in rapid succession, the automatic climate control does not have sufficient time to adjust the set temperature. ◀

Adjusting temperature in upper body region

1. Press the **MENU** button.
This opens the start menu.
2. Move the controller to the left to open "Climate".
3. Select "Vent settings" and press the controller.

4. Select the driver's or front passenger side if necessary. Move the controller to the right or left repeatedly until the driver's or front passenger side is selected.
5. Move the controller to select the field.
6. Turn the controller to adjust the temperature.



Defrosting windows and removing condensation



Quickly remove ice and condensation from the windshield and front side windows.

To do this, also switch on the cooling function.

Rear window defroster



The rear window defroster switches off automatically after a while. Depending on the vehicle equipment, upper wires are used as an antenna and are not part of the rear window defroster.

Air volume, manual



You can vary the air volume by pressing on the corresponding side. You can reactivate the automatic mode for the air volume with the AUTO button.

Air distribution, manual

You can route the air flowing out into the vehicle interior via various programs, separately for the driver's and passenger's side.

- ▷ Upper body region
- ▷ Upper body region and footwell
- ▷ Footwell

- ▷ Driver's side: windows and footwell
- ▷ Individual program

Selecting program

 Press the button repeatedly until the desired program is shown on the Control Display.

Adjusting air distribution individually – individual program

The settings are stored in this program.

iDrive, for operating principle refer to page 16.

1. Press the **MENU** button.
This opens the start menu.
2. Move the controller to the left to open "Climate".
3. Select "Vent settings" and press the controller.
The driver's and front passenger side can be adjusted separately with the fields on the right or left side.
4. Select the driver's or front passenger side if necessary.
Move the controller to the right or left repeatedly until the driver's or front passenger side is selected.
5. Select the desired field by moving the controller.
6. Turn the controller to adjust the air distribution.



Driver's side:

- 1 Air toward the windshield and side windows
- 2 Air for the upper body
- 3 Air to footwell

Front passenger side:

- 4 Air for the upper body
- 5 Air to footwell

 Pressing the AUTO button cancels the manual air distribution settings. ◀

The automatic mode for the air volume remains effective with manual air distribution.

Switching cooling function on and off



The cooling function cools and dehumidifies the incoming air before also reheating it as required, according to the temperature setting. This function is only available when the engine is running.

The cooling function helps to avoid condensation on the window surfaces or to quickly remove them.

Depending on the weather, the windshield may fog over briefly when the engine is started.

The cooling function is switched on automatically with the AUTO program.

Maximum cooling



Maximally cooled air is obtained as quickly as possible at an outside temperature above approx. 32 °F / 0 °C and with the engine running.

The automatic climate control switches into the recirculated-air mode at the lowest temperature. The maximum air volume flows out of the air vents for the upper body. Therefore, open these vents for maximum cooling.

AUC Automatic recirculated-air control/recirculated-air mode



You can respond to pollutants or unpleasant odors in the immediate environment by suspending the supply of outside air. The system then recirculates the air currently within the vehicle. During AUC operation, a sensor detects pollutants in the outside air and controls the shut-off automatically.

By pressing the button repeatedly, you can request three operating modes:

- ▷ LED off: outside air flows in continuously.
- ▷ Left LED on, AUC mode: the system detects pollutants in the outside air and shuts off the supply as needed.
- ▷ Right LED on, recirculated-air mode: the supply of outside air is permanently shut off.

⚠ Should the windows fog up in the recirculated-air mode, press the AUTO button or switch off the recirculated-air mode and increase the air volume if necessary.

The recirculated-air mode should not be used without interruption over an extended period of time, as the air quality inside the vehicle deteriorates continuously. ◀

Residual heat

The heat stored in the engine is used to heat the passenger compartment, e.g. while stopped at a school to pick up a child.

Switching on



Pressing the right side switches on the residual heat utilization when the following conditions are met:

- ▷ up to 15 minutes after switching off the engine
- ▷ with the engine at operating temperature
- ▷ with sufficient battery voltage
- ▷ at an outside temperature below 77 °F / 25 °C

REST appears on the display of the automatic climate control when the residual heat utilization is switched on.

From radio readiness the interior temperature, the air volume and the air distribution can be set.

Switching off

You can select the lowest blower speed by pressing and holding the left side. Pressing again switches off the residual heat utilization. REST disappears from the display of the automatic climate control.

Switching automatic climate control on and off



You can select the lowest blower speed by pressing and holding the left side. Pressing again switches off the automatic climate control.

You switch on the system again by pressing any button of the automatic climate control.

Front ventilation

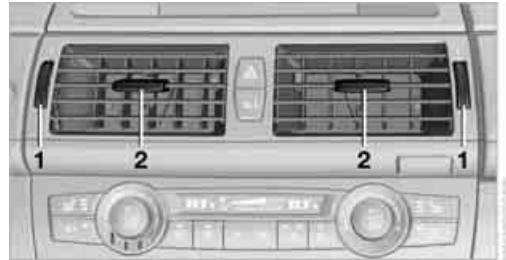

- 1 Knurled wheels to smoothly open and close air vents
- 2 Levers to change the air vent direction



Do not drop any foreign objects into the air vents, otherwise these could be catapulted outwards and lead to injuries. ◀

Ventilation for cooling

Adjust the air vents to direct the flow of cool air in your direction, for instance, if the interior has become too warm, etc.

Draft-free ventilation

Set the air vents so that the air flows past you and is not directed straight at you.

Ventilation in rear

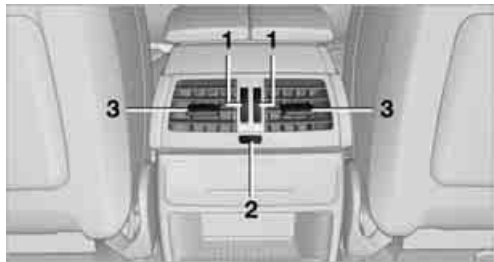

- 1 Knurled wheels to smoothly open and close air vents
- 2 Knurled wheel for adjusting the temperature in the upper body region:
 - ▷ Turn toward blue: colder
 - ▷ Turn toward red: warmer
- 3 Levers to change the air vent direction

Heating and ventilation, 3rd row seats

The air in the area of the 3rd row seats can be heated or recirculated. Air vents are located in the storage compartment area between the seats and in the footwell of the 3rd row seats.

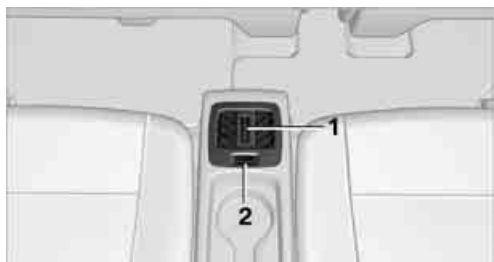

- 1 Knurled wheel:
 - ▷ Activating heating and distributing air in footwell:
Turn toward front
 - ▷ Distributing air in storage compartment area between seats:
Turn toward rear
- 2 Button for switching on blower:
LED lights up

 The heating is not ready for operation without switching on the blower. After the heating is switched off, the blower can be used

to recirculate the air within the vehicle, e.g. at high temperatures. To do this, turn the knurled wheel **1** toward the rear and switch on the blower, button **2**. ◀

Microfilter/activated-charcoal filter

The microfilter removes dust and pollen from the incoming air. The activated-charcoal filter provides additional protection by filtering gaseous pollutants from the outside air. This combined filter is changed during maintenance by your BMW Sports Activity Vehicle Center. You can select a display of more detailed information on the Control Display, refer to page 75.

Rear automatic climate control*

The control unit of the rear automatic climate control is located in the center console in the rear.

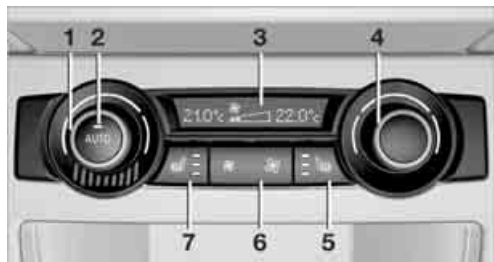

- 1 Temperature, left rear seating area
- 2 AUTO program
- 3 Display
- 4 Temperature, right rear seating area
- 5 Seat heating, right rear seat
- 6 Air volume, manual
- 7 Seat heating, left rear seat

The current setting for the temperature and the air volume is shown on the display **3**.

Activating rear automatic climate control

iDrive, for operating principle refer to page 16.

1. Press the **MENU** button.
This opens the start menu.
2. Move the controller to the left to open "Climate".
3. Select "Rear climate control" and press the controller.

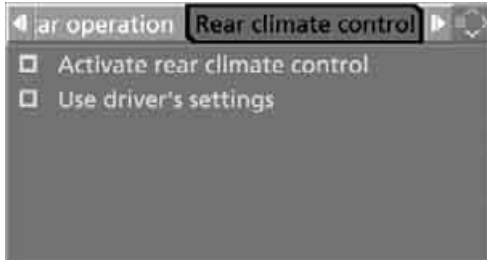

4. Select the desired settings and press the controller.

The rear automatic climate control is activated and the settings of the automatic climate control on the driver's side can be applied if necessary.

 The rear automatic climate control is not ready for operation if the automatic climate control is switched off. When activating the function of the automatic climate control for defrosting the windows and removing condensation, the rear automatic climate control is also not ready for operation. ◀

AUTO program



The AUTO program assumes the adjustment of the air distribution toward the upper body and in the footwell, as well as the air volume for you. It also adapts your instructions for the temperature to outside influences throughout the year.

Temperature



Set the desired temperature individually on the left and right side.

The rear automatic climate control adjusts this temperature as quickly as possible at any time of year, if necessary with the maximum cooling or heating capacity, and then keeps it constant.

 When switching between different temperature settings in rapid succession, the rear automatic climate control does not have sufficient time to adjust the set temperature. ◀

Air volume, manual



You can vary the air volume by pressing on the corresponding side. You can reactivate the automatic mode for the air volume with the AUTO button.

Switching off rear automatic climate control



You can select the lowest blower speed by pressing and holding the left side. Pressing again switches off the rear automatic climate control.

 The rear automatic climate control can also be switched off with iDrive. To switch on the rear automatic climate control again, the system must first be reactivated, refer to Activating rear automatic climate control. ◀

You switch on the system again by pressing any button of the rear automatic climate control.

Ventilation in rear

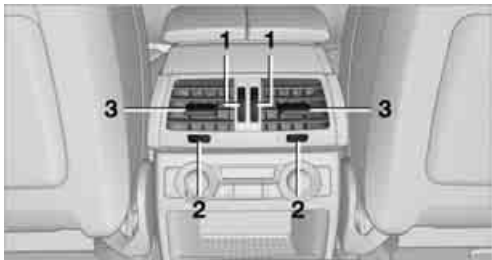

- 1 Knurled wheels to smoothly open and close air vents
- 2 Knurled wheels to adjust temperature in upper body region; can be adjusted separately for left and right:
 - ▷ Turn toward blue: colder
 - ▷ Turn toward red: warmer
- 3 Levers to change the air vent direction

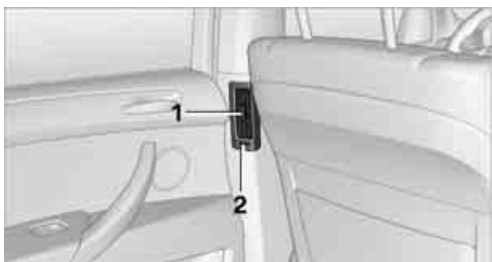

- 1 Lever to change the air vent direction
- 2 Knurled wheel to smoothly open and close air vents

For information on the ventilation of the 3rd row seats, refer to page [111](#).

Parked car ventilation*

The concept

The parked car ventilation blows air into the passenger compartment to lower interior temperatures.

It is ready to use in the parked car mode at any outside temperature.

You can set two different times for the system to start. The parked car ventilation can also be switched on and off directly. It remains switched on for 30 minutes.

Since the system uses a substantial amount of electrical current, you should refrain from activating it twice in succession without allowing the battery to be recharged in normal operation between use.

The air emerges through the upper body region air vents in the instrument panel. Therefore, please open the air vents.

The parked car ventilation is operated via iDrive.

Switching on and off directly

iDrive, for operating principle refer to page [16](#).

1. Open the start menu.
2. Move the controller to the left to open "Climate".
3. Select "Parked car operation" and press the controller.
4. Select "Automatic ventilation" and press the controller.
5. Select "Parked car ventilation" and press the controller.

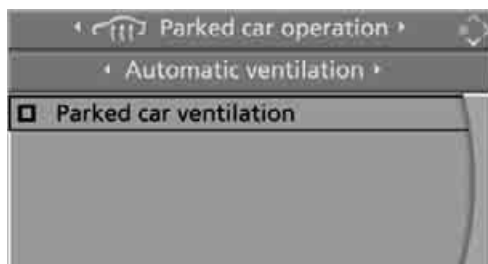

 The parked car ventilation is switched on.

☞ The symbol on the display of the automatic climate control flashes.

Preselecting activation times

iDrive, for operating principle refer to page 16.

1. Open the start menu.
2. Move the controller to the left to open "Climate".
3. Select "Parked car operation" and press the controller.
4. Select "Activation time" and press the controller.
5. Move the controller to the left or right to select "Timer 1" or "Timer 2".



6. Select the time and press the controller.

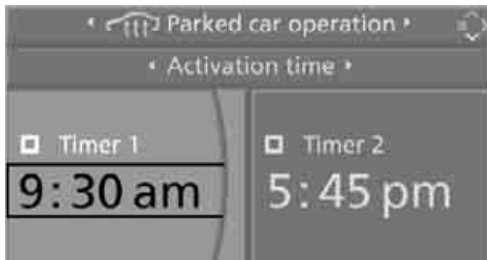

The first time setting is highlighted.

7. Turn the controller to make the adjustment.
8. Press the controller to apply the setting. The next setting is highlighted.
9. Make the remaining adjustments. After the last adjustment, the time is stored.

Activating activation time

Move the controller to the left or right to select "Timer 1" or "Timer 2" and press the controller.

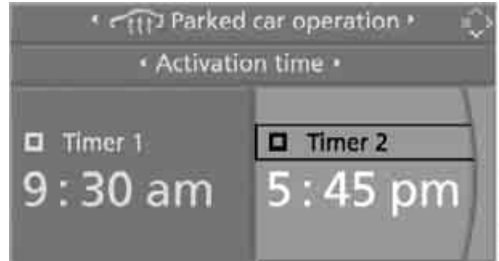

☑ The activation time is activated.

The ☞ symbol on the display of the automatic climate control lights up.

The ☞ symbol on the display of the automatic climate control flashes when the parked car ventilation has switched on.

▶ The parked car ventilation is only available for activation within the next 24 hours. Then it must be activated again. ◀

Integrated universal remote control*

The concept

The integrated universal remote control can replace as many as three hand-held transmitters for various remote-controlled accessories, such as garage and gate or lighting systems. The integrated universal remote control registers and stores signals from the original hand-held transmitters.

The signal of an original hand-held transmitter can be programmed on one of the three memory buttons **1**. Then with the ignition switched on, this programmed memory button **1** can be used to operate the respective feature. The LED **2** flashes to confirm transmission of the signal.

Should you sell your vehicle one day, be sure to delete the stored programs beforehand for your safety, refer to page **116**.

 To prevent possible damage or injury, before programming or using the integrated universal remote control, always inspect the immediate area to make certain that no people, animals or objects are within the travel range of the device. Also, comply with the safety precautions of the original hand-held transmitter. ◀

Checking compatibility

 If you see this symbol on the packaging or in the manual supplied with the original hand-held transmitter, it is safe to assume that it is compatible with the integrated universal remote control.

 Should you have additional questions, please contact your BMW Sports Activity Vehicle Center or call: 1-800-355-3515. Information is also provided on the Internet at: www.bmwusa.com or www.homelink.com.

HomeLink is a registered trademark of Johnson Controls, Inc. ◀

Programming

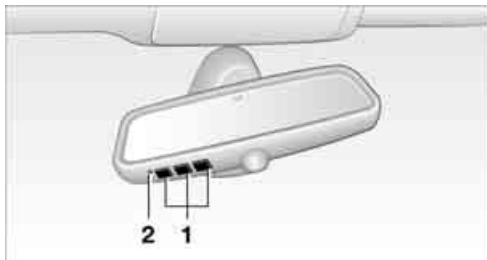

- 1** Memory buttons
- 2** LED

Fixed-code hand-held transmitters

1. Switch on ignition, refer to page **59**.
2. When starting operation for the first time: Press the left and right-hand memory button **1** for approx. 20 seconds until the LED **2** flashes quickly. All stored programs are deleted.
3. Hold the original hand-held transmitter at a distance of approx. 4 in/10 cm to 12 in/30 cm from the memory buttons **1**.
 The required distance between the hand-held transmitter and the memory buttons **1** depends on the relevant system of the original hand-held transmitter used. ◀
4. Simultaneously press the transmit button on the original hand-held transmitter and the desired memory button **1** on the integrated universal remote control. The LED **2** flashes slowly at first. As soon as the LED **2** flashes rapidly, release both buttons. If the LED **2** does not flash rapidly after approx. 15 seconds, alter the distance and repeat the step.
5. To program other original hand-held transmitters, repeat steps 3 and 4.

The corresponding memory button **1** is now programmed with the signal of the original hand-held transmitter.

You can operate the device when the engine is running or when the ignition is switched on.

 If the device cannot be used after repeated programming, check whether the original hand-held transmitter uses an alternating-code system. To do so, either read the instructions for the original hand-held transmitter or hold down the programmed memory button **1** of the integrated universal remote control. If the LED **2** on the integrated universal remote control flashes rapidly for a short time and then remains lit for approx. 2 seconds, this indicates that the original hand-held transmitter uses an alternating-code system. In the case of an alternating-code system, program the memory buttons **1** as described at Alternating-code hand-held transmitters. ◀

Alternating-code hand-held transmitters

To program the integrated universal remote control, consult the operating instructions for the equipment to be set. You will find information there on the possibilities for synchronization.

When programming hand-held transmitters that employ an alternating code, please observe the following supplementary instructions:

 Programming will be easier with the aid of a second person. ◀

1. Park your vehicle within the range of the remote-controlled device.
2. Program the integrated universal remote control as described above in the section Fixed-code hand-held transmitters.
3. Locate the button on the receiver of the device to be set, e.g. on the drive unit.
4. Press the button on the receiver of the device to be set. After step 4, you have approx. 30 seconds for step 5.
5. Press the programmed memory button **1** of the integrated universal remote control three times.

The corresponding memory button **1** is now programmed with the signal of the original hand-held transmitter.

 Should you have questions, please contact your BMW Sports Activity Vehicle Center. ◀

Deleting all stored programs

Press the left and right-hand memory button **1** for approx. 20 seconds until the LED **2** flashes quickly:

All stored programs are deleted.

Reassigning individual programs

1. Hold the original hand-held transmitter at a distance of approx. 4 in/10 cm to 12 in/30 cm from the memory buttons **1**.

 The required distance between the hand-held transmitter and the memory buttons **1** depends on the relevant system of the original hand-held transmitter used. ◀

2. Press the desired memory button **1** of the integrated universal remote control.
3. When the LED **2** flashes slowly after approx. 20 seconds, press the transmit button of the original hand-held transmitter. Release both buttons as soon as the LED **2** flashes rapidly. If the LED **2** does not flash rapidly after approx. 15 seconds, alter the distance and repeat the step.

Digital compass*



- 1 Adjustment button
- 2 Display

The display indicates the cardinal or intercardinal direction in which you are currently driving.

Setting compass zones

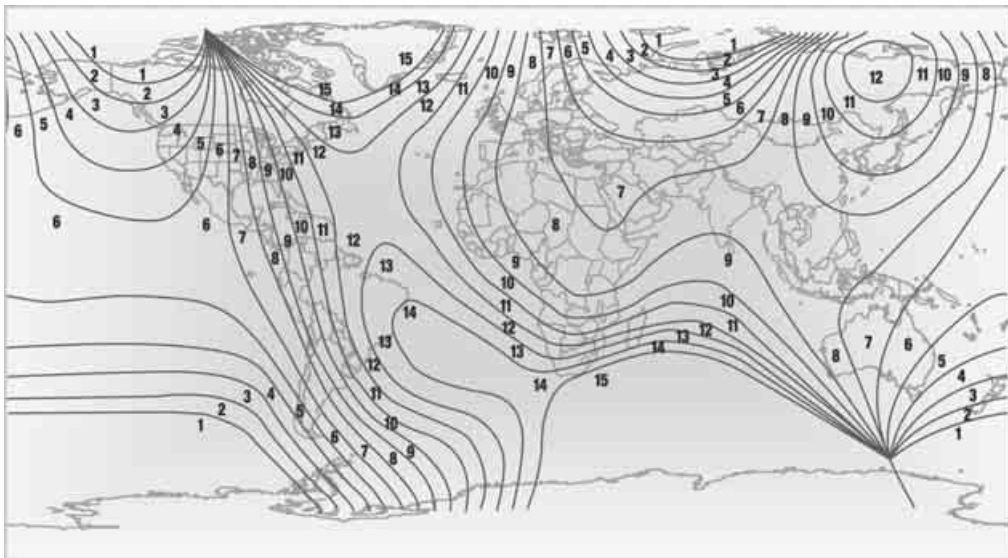

Set the respectively applicable compass zone in your vehicle so that the compass functions properly, refer to the map of the world with compass zones.

To set the compass zones, press the adjustment button for approx. 3-4 seconds. The display indicates the number of the currently set compass zone.

Operating principle

You can run various functions by pressing the adjustment button with a pointed object, e.g. a ball-point pen etc. The following setting options are displayed consecutively, depending on how long the adjustment button is pressed:

- ▷ Press briefly: switch display on/off
- ▷ 3 to 6 seconds: set compass zone
- ▷ 6 to 9 seconds: calibrate compass
- ▷ 9 to 12 seconds: set left/right-hand drive vehicle
- ▷ 12 to 15 seconds: setting language

To change the zone setting, briefly press the adjusting button repeatedly until the number of the compass zone that applies to your current position is displayed.

The compass will be operational again after approx. 10 seconds.

Calibrating digital compass

In the following situations, the digital compass must be calibrated:

- ▷ The wrong cardinal direction appears on the display.
- ▷ The cardinal direction displayed does not change despite a change in the direction of travel.
- ▷ Not all cardinal directions are displayed.

Procedure

1. Make sure that there are no large metal objects or overhead power lines in the vicinity of your vehicle and that you have enough space to drive in a circle.
2. Input the currently applicable compass zone.
3. Press the adjustment button for approx. 6-7 seconds to display C. Then drive in a complete circle at least once at a maximum speed of 4 mph/7 km/h.
If the calibration is successful, display C is replaced with the points of the compass.

Setting right/left-hand drive vehicle

Your digital compass is already set to right or left-hand drive vehicle to match your vehicle at the factory.

Setting language

You can set the language of the display.

Press the adjustment button for approx. 12-13 seconds. Briefly press the adjustment button again to change between English "E" and German "O".

The setting is automatically stored after approx. 10 seconds.

Roller sun blinds for rear side windows*

Pull the loop of the roller sun blind and hook onto bracket.

 Do not open the window with the roller blind raised, as otherwise there is a danger of damage, and therefore a danger of injuries at higher speeds. ◀

Glove compartment

Opening

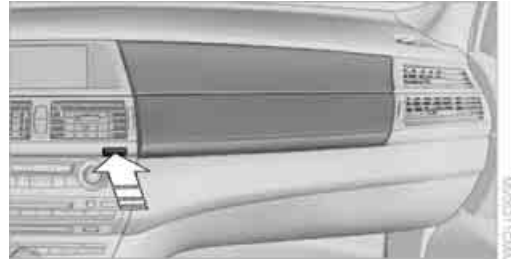

Press the button. The covers open upward and downward and the lighting in the glove compartment switches on.

 To prevent injury in the event of an accident while the vehicle is being driven, close the glove compartment immediately after use. ◀

Closing

Press one of the two covers closed.

Opening manually

In the event of a power failure or electrical malfunction, you can open the glove compartment manually.

1. Position the screwdriver from the onboard tool kit, refer to page 247, on the instrument panel at the side and open the cover, arrow.



2. Pull the strap upward, arrow. The glove compartment is opened manually.



Center armrest

A storage compartment is located under the armrest between the front seats and, depending on the vehicle's equipment, also a cover for the mobile phone bracket or the snap-in adapter. Also refer to page 208.

Opening cover



Press the button; the respective cover folds upward.

Connection for external audio device

You can connect an external audio device such as a CD or MP3 player and play audio tracks over the vehicle's loudspeaker system:

- ▷ AUX-In connection, refer to page 188
- ▷ USB audio interface*, refer to page 189

Flashlight*

The flashlight is located in the storage compartment between the front seats. Pull the flashlight out of the holder when needed.

Battery change

To remove and insert the batteries, screw off the flashlight head.

-  Return used batteries to a recycling collection point or to your BMW Sports Activity Vehicle Center. ◀

Storage compartments

There are other storage compartments in the doors as well as in the front and rear center console*.

Storage nets* are located on the backrests of the front seats.

-  Do not stow hard or sharp-edged objects in the storage nets or the net, otherwise there is an increased risk of injury in an accident. ◀

Clothes hooks

Clothes hooks are located near the grab handles in the rear.

-  When hanging clothing on the hooks, ensure that it will not obstruct the driver's vision. Do not hang heavy objects on the hooks. If you do so, they could cause personal injury to occupants during braking or evasive maneuvers. ◀

Cup holders

 Do not place containers made of glass in the cup holders. This would lead to an increased risk of injury in the event of an accident. Do not force unsuitable containers into the cup holders, as otherwise damage can result. ◀

Front



Slide back the cover.

Rear



Unlock the center armrest with the button in the lower section of the opening and fold down.

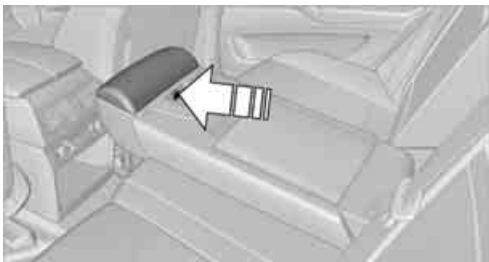

Press the button; the cover folds forward.

With 3rd row seats

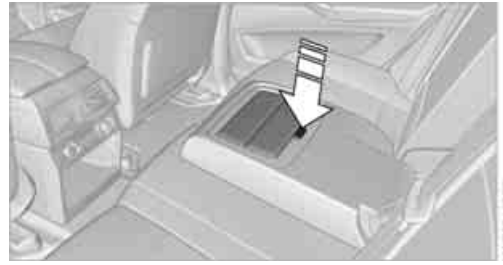

Fold down the center armrest.
Press the button; the cup holders are opened.

3rd row seats*

The cup holders are located in the center console between the seats.

Ashtray

Front

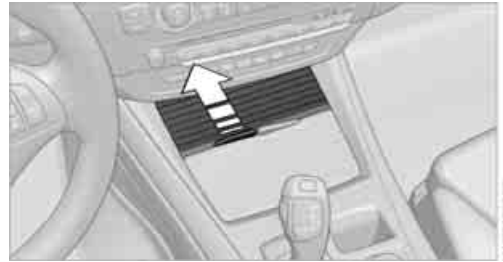

To open the cover, slide it forward.



Press the button. The ashtray insert raises slightly and can be removed.

Rear

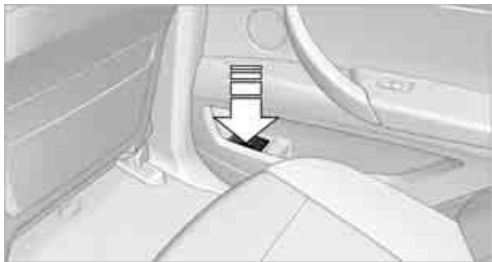

Press the entire cover down. The ashtray rises and can be removed.

Lighter

Front



Press in the lighter with the engine running or the ignition switched on.

The lighter can be removed as soon as it pops back out.

⚠ Hold or touch the hot cigarette lighter by the knob only. Holding or touching it in other areas could result in burns. Always take along the remote control when you leave the vehicle, otherwise children could, for example, use the lighter and burn themselves. ◀

Rear



Refer to Cigarette lighter, front.

Connecting electrical devices

Sockets

With the engine running or the ignition switched on, the cigarette lighter socket can be used as a power outlet for hand flashlights, car vacuum cleaners, etc., with power ratings of up to approx. 200 W at 12 V. Avoid damaging the socket due to inserting plugs of different shapes or sizes. The same is true for all power outlets in the vehicle.

In cargo bay

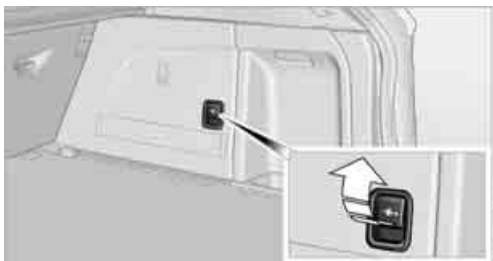

Access to socket:
Fold open the cover.

In the rear center console



Depending on your vehicle's equipment package, the socket in the rear is covered with a cap or equipped with a lighter. Refer to Cigarette lighter, front, page 121.

Access to socket:
Remove cap or lighter.

In storage compartment under center armrest



Access to socket*:
Pull off the cover.

Cargo bay

Roll-up cover

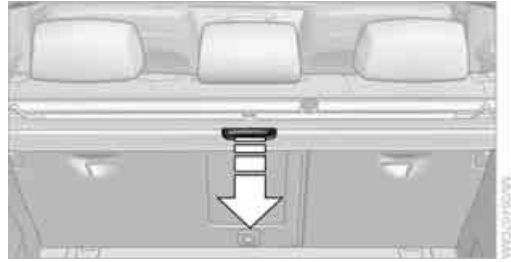

Pull out the roll-up cover and hook it into the brackets.

⚠ Do not place heavy or hard objects on the roll-up cover. If you do so, they may already pose a danger to vehicle occupants during braking or evasive maneuvers. Do not allow the roll-up cover to snap back, otherwise it can be damaged. ◀

Removing

1. Unlock the case with the button, arrow 1.

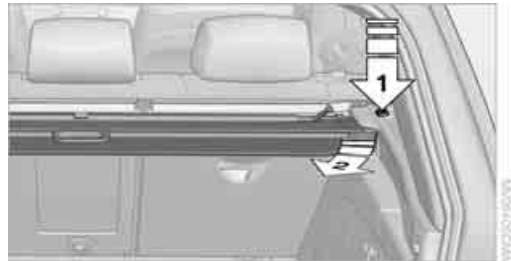

2. Swing the case somewhat to the left, arrow 2, and remove.

Installing

When installing, proceed in the opposite order of removal.



1. Lay on the case on the left-hand side and push it forward, arrow 1.
2. Swing the case toward the inside, refer to arrow 2.
3. Push the case forward at the ends until it engages in the two side brackets.
4. Check whether the case is properly locked in place by pulling it with a sudden movement.

Cargo bay, expanding

The rear seat backrest is divided. You can fold down both sides separately in order to expand the cargo bay.



Reach into the recess and pull toward the front.

⚠ When you fold back the backrest, be sure that the catch engages securely. The red warning indicator disappears in the recess when the catch is engaged. If it is not properly engaged, transported cargo could enter the passenger compartment during braking or evasive maneuvers and endanger the vehicle occupants. ◀

⚠ To ensure that the safety systems continue to provide optimized protection, please observe the safety belt information on page 42. ◀

Storage compartments in cargo bay

Depending on the vehicle's equipment, the following storage compartments are provided in the cargo bay.

- ▷ Storage compartments behind the removable side panels in the cargo bay on the right and left* and under the floor panel flap.
- ▷ Storage tray* under the floor panel flap, capacity approx. 21 US gal/80 liter.
- ▷ Retaining straps* on the left and right side panel for securing small objects.
- ▷ Hooks*, e.g. for hanging up shopping bags or carrier bags on the left and right in the cargo bay.
- ▷ Net* on the left side panel of the cargo bay for smaller objects.
- ▷ Lashing rail with lashing eyes*. You can secure heavy-duty cargo straps on the lashing eyes.

They can be removed at the notches in the rails. To move the lashing eyes, press the button.



Read and comply with the information enclosed with the heavy-duty cargo straps. ◀

Floor panel flap

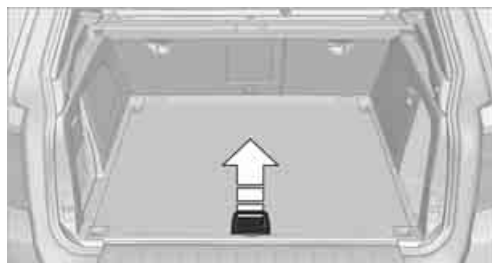

To access the onboard toolkit etc.

To open, swing up the flap by the handle, refer to arrow.

The floor panel flap can be locked.

Adaptive fastening system*

The adaptive fastening system is used to divide up the cargo bay. It consists of two brackets with a telescopic rail and retaining straps. These are guided into the two rails on the cargo bay floor.

⚠ Before using the adaptive fastening system, fold up and lock the backrest of the 2nd or 3rd row seats, as otherwise the cargo could be thrown around in the vehicle interior in an accident. ◀

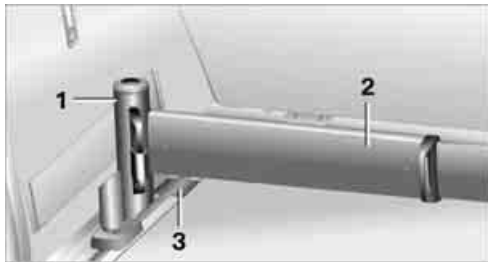

- 1 Brackets
- 2 Telescopic rail
- 3 Notch in the cargo bay rail

Mounting brackets

The two brackets are connected with a telescopic rail.

1. Insert the brackets at the respective notch in the rail on the cargo bay floor.
2. Press down the brackets to push them into the desired position.
3. Check the firm seating of the brackets. They must be clearly heard to engage.

⚠ Do not lay cargo on the brackets, as otherwise they could be unlocked. ◀

Dividing up cargo bay

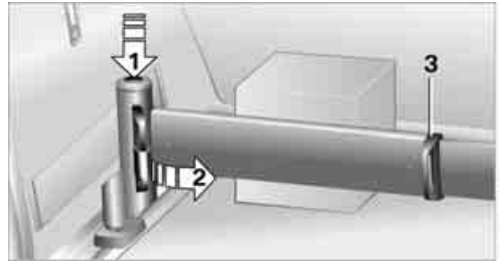

You can position the cargo as follows:

- ▷ between the rear backrest and the telescopic rail
- ▷ between the telescopic rail and the retaining strap

Positioning cargo between telescopic rail and retaining strap:

1. Lay the cargo on the telescopic rail. Press the button, arrow 1, and route the retaining strap around the cargo, arrow 2.
2. Hook the retaining strap into the mount 3 on the telescopic rail.
3. Press the button of the bracket, arrow 1. The retaining strap is tensioned.

▷ You can also hook both retaining straps into each other. ◀

When you are finished using the adaptive fastening system, unhook the retaining strap and guide it back into the bracket in order to prevent damage and injury.

Then slide the fastening system toward the front in order to permit the best possible use of the cargo bay.

Removing brackets

Press down the brackets, slide them up to the notches of the rails and remove them.

Ski bag*

The ski bag is designed for safe, clean transport of up to 4 pairs of standard skis or up to 2 snowboards.

With the ski bag you can stow skis with a length of up to 6.9 ft/2.10 m. When skis of 6.9 ft/2.10 m in length are loaded, the ski bag will tend to contract, reducing its overall capacity.

 Before loading the ski bag, fold in the display screen of the DVD system in the rear*, as otherwise the display screen could be damaged. ◀

Loading

1. Fold down the center armrest, press the button and open the cover.

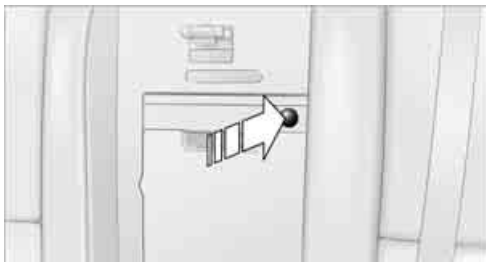

2. Press the button again; the cover in the cargo bay opens. If you press the button firmly the first time, this cover also opens.
3. Extend the ski bag between the front seats and fill it. The zipper facilitates access to the stowed items and drying of the ski bag.
4. Insert the latch plate of the ski bag retaining strap into the center safety belt buckle that is marked CENTER.



Only stow clean skis in the ski bag. Wrap sharp edges to prevent damage.

Securing cargo

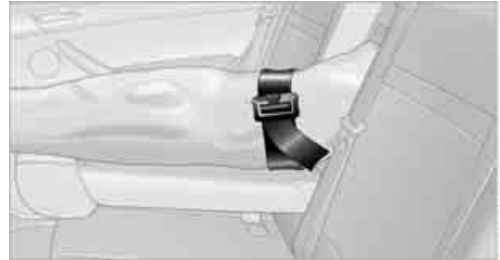

After loading, secure the ski bag and its contents. Tighten the retaining strap on the tensioning buckle for this purpose.

 Secure the ski bag in this way. If you fail to do so, it could endanger occupants during braking or evasive maneuvers. ◀

To store the ski bag, perform the above steps in reverse order.

Removing ski bag

The ski bag can be completely removed, e.g. for faster drying or to allow you to put it to other uses.

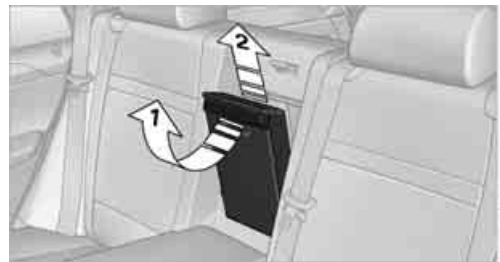

1. Pull the handle toward the front, arrow 1.
2. Take out the ski bag upward, arrow 2.
3. Close the cover in the cargo bay.

 Details on various inserts are available from your BMW Sports Activity Vehicle Center. ◀



Driving tips

This section is designed to provide you with extra support by supplying information useful in dealing with specific driving and operating conditions.

Things to remember when driving

Break-in period

Moving parts need breaking-in time to adjust to each other. To ensure that your vehicle continues to provide optimized economy of operation throughout an extended service life, we request that you devote careful attention to the following section.

Engine and differential

Always obey all official speed limits.

Up to 1,200 miles/2,000 km

Drive at changing engine and vehicle speeds, however do not exceed 4,500 rpm or 100 mph/160 km/h.

Avoid full-throttle operation and use of the transmission's kick-down mode during these initial miles.

From 1,200 miles/2,000 km

The engine and vehicle speed can gradually be increased.

Tires

Due to technical factors associated with their manufacture, tires do not achieve their full traction potential until after an initial break-in period. Therefore, drive reservedly during the first 200 miles/300 km.

Brake system

Brakes require an initial break-in period of approx. 300 miles/500 km to achieve optimized contact and wear patterns between brake pads and rotors. Drive in a reserved manner during this break-in period.

Following part replacement

Observe the break-in instructions again if components mentioned above must be replaced after subsequent driving operation.

Saving fuel

The fuel consumption of your vehicle depends on various factors. Through a few simple steps, your driving style, and regular maintenance, you can have a positive influence on your fuel consumption and environmental impact.

Removing unnecessary cargo

Additional weight increases fuel consumption.

Removing add-on parts after use

Remove unneeded auxiliary mirrors, roof or rear luggage racks after use. Add-on parts attached to the vehicle impede the aerodynamics and increase the fuel consumption.

Closing windows and panorama glass sunroof

An open panorama glass sunroof or open windows likewise increase the drag coefficient and therefore the fuel consumption.

Check tire inflation pressures regularly

Check and correct the tire inflation pressure as needed at least twice a month and before long trips.

An insufficient tire inflation pressure increases the rolling resistance and thus increases the fuel consumption and tire wear.

Driving off immediately

Do not allow the engine to warm up by leaving it running while the vehicle remains stationary. Instead, begin to drive at a moderate engine speed. This is the fastest way for the cold engine to reach its operating temperature.

Thinking ahead when driving

Avoid unnecessary acceleration and braking. To do so, maintain the appropriate distance from the vehicle in front of you. An anticipatory

and smooth driving style reduces fuel consumption.

Avoiding high engine speeds

Driving at a low engine speed reduces fuel consumption and minimizes wear.

Taking advantage of coasting

The flow of fuel is interrupted when coasting.

Switching off engine during longer stops

Switch off the engine at longer stops such as traffic signals, railroad crossings, or in traffic jams. Even having the engine switched off for approx. 4 seconds results in fuel savings.

Switching off functions currently not required

Functions such as air conditioning, seat heating, or rear window defrosting consume a lot of energy and require additional fuel. Their influence is particularly pronounced in city traffic and stop & go operation. For this reason, it is a good idea to switch these functions off when they are not really needed.

Having maintenance carried out

Have the vehicle serviced regularly in order to achieve the optimum economy and service life of your vehicle. BMW recommends having the maintenance performed by a BMW Sports Activity Vehicle Center. Also please pay attention to the BMW maintenance system, refer to page 245.

General driving notes

Closing liftgate/tailgate

 Operate the vehicle only when the tailgate and liftgate are completely closed. Otherwise, exhaust fumes could enter into the passenger compartment. ◀

If it is absolutely necessary to drive with the liftgate open:

1. Close all windows and the panorama glass sunroof.
2. Increase the air volume of the automatic climate control to a high level, refer to page 108.

Hot exhaust system

 As in all vehicles, extremely high temperatures are generated on the exhaust system. Do not remove the heat shields installed adjacent to it, and never apply undercoating to them. When driving, standing at idle and while parking take care to avoid possible contact between the hot exhaust system and any highly flammable materials such as hay, leaves, grass, etc. Such contact could lead to a fire, and with it the risk of serious property damage as well as personal injury. Do not touch hot tailpipes, as otherwise there is a danger of burns. ◀

Hydroplaning

 When driving on wet or slushy roads, reduce road speed. If you do not, a wedge of water can form between tires and road surface. This phenomenon is referred to as hydroplaning, and is characterized by a partial or complete loss of contact between the tires and the road surface, ultimately undermining your ability to steer and brake the vehicle. ◀

The risk of hydroplaning increases as the tread depth of the tires decreases, also refer to Mini-mum tread depth on page 238.

Driving through water

 Do not drive through water on the road if it is deeper than 20 in/50 cm, and then only at walking speed at the most. Otherwise, the vehicle's engine, the electrical systems and the transmission may be damaged. ◀

Braking safely

Your BMW is equipped with ABS as a standard feature. In situations that require it, it is best to brake with full force. Since the vehicle maintains steering responsiveness, you can still avoid

possible obstacles with a minimum of steering effort.

Pulsation of the brake pedal, combined with sounds from the hydraulic circuits, indicate that ABS is in its active mode.

 Do not drive with your foot resting on the brake pedal. Even light but consistent pedal pressure can lead to high temperatures, brake wear and possibly even brake failure. ◀

Driving in wet conditions

When roads are wet or there is heavy rain, briefly exert gentle pressure on the brake pedal every few miles. Monitor traffic conditions to ensure that this maneuver does not endanger other road users. The heat generated in this process helps dry the pads and rotors to ensure that full braking efficiency will then be available when you need it.

Hills

 To prevent overheating and the resulting reduced efficiency of the brake system, drive long or steep downhill gradients in the gear in which the least braking is required. Even light but consistent pressure on the brake pedal can lead to high temperatures, brake wear and possibly even brake failure. ◀

The braking effect of the engine can be further increased by downshifting in the manual mode of the automatic transmission, if necessary into first gear, refer to page 65. This prevents an excessive strain on the brakes.

 Do not drive in idle or with the engine stopped, otherwise there will be no engine braking action or support of the braking force and steering.

Never allow floor mats, carpets or any other objects to protrude into the area of movement of the pedals and impair their operation. ◀

Corrosion on brake rotors

When the vehicle is driven only occasionally, during extended periods when the vehicle is not used at all, and in operating conditions where brake applications are less frequent, there is an increased tendency for corrosion to form on

rotors, while contaminants accumulate on the brake pads. This occurs because the minimum pressure which must be exerted by the pads during brake applications to clean the rotors is not reached.

Should corrosion form on the brake rotors, the brakes will tend to respond with a pulsating effect that even extended application will fail to cure.

When vehicle is parked

Condensation forms in the automatic climate control system during operation, and then exits under the vehicle. Traces of condensed water under the vehicle are therefore normal.

Before driving into a car wash

Fold in the exterior mirrors, refer to page 51, otherwise they could be damaged due to the width of the vehicle.

Release the parking brake, particularly when you have activated Automatic Hold, refer to page 61.

General information on the care and maintenance of your BMW is contained in the Caring for your vehicle brochure.

Mixed tires*

 Before driving into a car wash, make sure that the vehicle width is not too large for the car wash, as otherwise the vehicle and the car wash could be damaged. ◀

Rear window wiper

The rear window wiper can be damaged in car washes. Take appropriate protective measures; ask the car wash operator if necessary.

With comfort access*

Insert the remote control into the ignition lock. The engine can be switched off in transmission position N, also refer to page 37.

Loading

⚠ To avoid loading the tires beyond their approved carrying capacity, never overload the vehicle. Overloading can lead to overheating and increases the rate at which damage develops inside the tires. The ultimate result can assume the form of a sudden blow-out. ◀

⚠ Make sure that no fluids leak in the cargo bay; otherwise the vehicle could be damaged. ◀

Determining loading limit



1. Locate the following statement on your vehicle's placard*:
 - ⚠** The combined weight of occupants and cargo should never exceed **YYY lbs.** or **XXX kg.** Otherwise, this could damage the vehicle and produce unstable vehicle operating conditions. ◀

2. Determine the combined weight of the driver and passengers that will be riding in your vehicle.
3. Subtract the combined weight of the driver and passengers from **YYY lbs.** or **XXX kg.**
4. The resulting figure equals the available amount of cargo and luggage load capacity. For example, if the **YYY** amount equals 1,400 lbs. and there will be five 150 lbs. passengers in your vehicle, the amount of available cargo and luggage load capacity is 650 lbs.:
1,400 lbs. minus 750 lbs. = 650 lbs.
5. Determine the combined weight of luggage and cargo being loaded on the vehicle. That weight may not safely exceed the available

cargo and luggage load capacity calculated in step 4.

6. If your vehicle will be towing a trailer, part of the load from your trailer will be transferred to your vehicle. Consult the manual for transporting a trailer to determine how this may reduce the available cargo and luggage load capacity of your vehicle.

Load

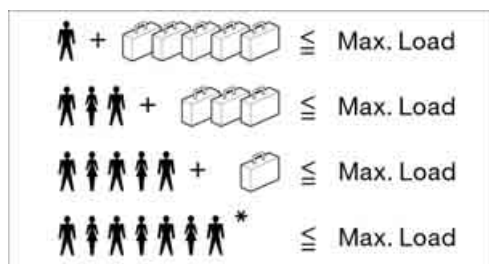

The permissible load is the total of the weight of occupants and cargo/luggage. The greater the weight of occupants, the less cargo/luggage can be transported.

Stowing cargo

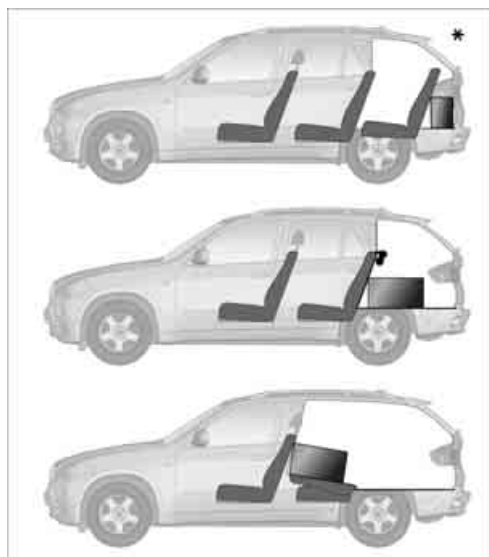

- ▷ Load heavy cargo as far forward and as low as possible, placing it directly behind the backrest.

- ▷ Cover sharp edges and corners.
- ▷ For very heavy cargo when the rear seat is not occupied, secure each safety belt in the opposite buckle.
- ▷ Do not pile objects higher than the top edge of the backrest.
- ▷ Wrap sharp-edged or pointed objects which could strike the rear window while driving.

Securing cargo

- ▷ Use the luggage net*, retaining straps*, or securing straps to hold down small and lightweight luggage and cargo.

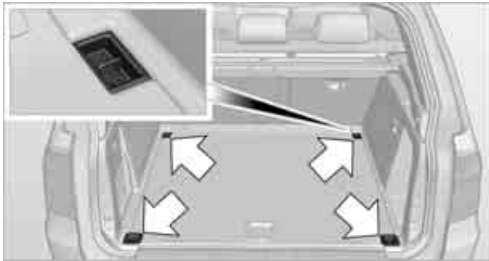

- ▷ For larger and heavier pieces, heavy-duty cargo straps* are available from your BMW Sports Activity Vehicle Center. Four lashing eyes mounted in the cargo bay are used to secure these heavy-duty cargo straps, refer to illustration.
- ▷ Please observe the special instructions supplied with the heavy-duty cargo straps.

⚠ Position and secure the cargo as described above, so that it cannot endanger the car's occupants, for example if sudden braking or evasive maneuvers are necessary. Use only the lashing eyes to secure heavy-duty cargo straps, refer to illustration, otherwise the cargo straps could become detached or the vehicle could be damaged.

Never exceed either the approved gross vehicle weight or either of the approved axle loads, refer to page 264, as excessive loads can pose a safety hazard, and may also place you in violation of traffic safety laws.

You should never transport unsecured heavy or hard objects in the passenger compartment, as they could fly around and pose a safety hazard to the vehicle's occupants during abrupt braking or evasive maneuvers. ◀

Roof-mounted luggage rack*

A special rack system is available as an option for your BMW. Please comply with the precautions included with the installation instructions.

Loading roof-mounted luggage rack

Because roof racks raise the vehicle's center of gravity when loaded, they have a major effect on its handling and steering response. You should therefore always remember not to exceed the approved roof load capacity, the approved gross vehicle weight or the axle loads when loading the rack.

You can find the specified weights under Weights on page 264.

The load on the roof must be evenly distributed and must not extend outward beyond the limits of the loading surface. Always stow the heaviest pieces on the bottom. Be sure that adequate clearance is maintained for raising the panorama glass sunroof, and that objects do not project into the opening path of the liftgate.

Secure roof-mounted cargo correctly and securely to prevent it from shifting or falling off during the trip.

Drive smoothly. Avoid sudden acceleration and braking maneuvers. Take corners gently.

Driving on poor roads

Your X5 is at home on all roads and surfaces. It combines a 4-wheel drive system with the advantages of a normal passenger car.



Do not drive on unpaved terrain, as otherwise the vehicle may be damaged. ◀

When you are driving on poor roads, there are a few points which you should strictly observe for your own safety, for that of your passengers, and for the safety of the vehicle:

- ▷ Familiarize yourself with the vehicle before driving off and avoid taking risks at all costs.
- ▷ Adapt your driving speed to the road conditions. The steeper and rougher the road surface is, the lower the speed should be.
- ▷ You can operate your vehicle on uphill and downhill gradients with a maximum slope of 50%. If you want to drive on uphill or downhill gradients of this kind, make sure beforehand that the engine oil and coolant levels are near the MAX mark, refer to page 242.
- ▷ Use the HDC Hill Descent Control when driving down extremely steep grades, refer to page 90. It is possible to start off on grades of up to 33%.
The permissible body roll is 50%.
- ▷ While driving, watch carefully for obstacles such as rocks or holes. Try to avoid these obstacles whenever possible.
- ▷ Please make sure that the undercarriage does not touch the ground, for example on crests and bumpy roads. The ground clearance of the vehicle is a maximum of approx. 8 in/20 cm. Please note that the ground clearance can vary depending on loading and the driving conditions of the vehicle.
- ▷ Only drive through water on roads up to a maximum depth of 20 in/50 cm and only at walking speed, making sure not to stop in the process.
- ▷ After driving through water at low speed, lightly press the brake pedal several times to dry the brakes and to prevent the braking effect from being reduced by wetness.

- ▷ Depending on the condition of the surface, it may be practical to briefly activate DTC, refer to DTC Dynamic Traction Control on page 89.
- ▷ If the drive wheels spin on one side, depress the accelerator pedal sufficiently so that the driving stability control systems can distribute the drive forces to the individual wheels.

Please note the following points after driving on poor roads to maintain the driving safety of your BMW:

- ▷ Clean the coarsest dirt from the body.
- ▷ Clean mud, snow, ice etc. from the wheels and tires and check the tires for damage.



Navigation

This chapter describes how you can enter destinations and specify your route so that your navigation system guides you reliably to your destination.

Starting navigation system*

Your navigation system can use satellites to ascertain the precise position of your vehicle and guide you reliably to any destination you enter.

Navigation DVD

The navigation system requires a special navigation DVD. The latest version is available at your BMW Sports Activity Vehicle Center.

Inserting navigation DVD



Use the lower drive for navigation DVD.

1. Insert the navigation DVD with the labeled side up.
The navigation DVD is automatically pulled in.
2. Allow several seconds for the system to scan the data from the DVD.

Removing navigation DVD

1. Press the  button **1**.
The DVD emerges slightly from the drive.
2. Remove the DVD.

If the DVD is not ejected from the drive, it is possible that it is blocked. In this case a message is also shown on the Control Display.

Display in assistance window

You can display the route or the current position in the assistance window. This display remains visible even if you change to another application.

1. Move the controller to the right to change to the assistance window.



2. Press the controller.
Other menu items are displayed.
3. Select the desired route view or "Current position".



4. Press the controller.

Displaying arrow view in map view

If the navigation system suggests a change of direction, the arrow view is briefly displayed.

1. Press the **MENU** button.
This opens the start menu.
2. Press the controller to open the **i** menu.
3. Turn the controller until "Settings" is selected and press the controller.
4. Turn the controller until "Language / Units" is selected and press the controller.
5. Change to upper field if necessary. Turn the controller until "Languages" is selected and press the controller.
6. Select "Arrow display pop-up instructions" and press the controller.

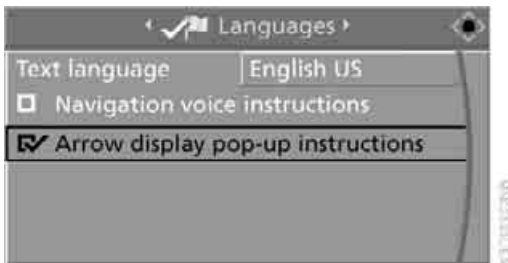

The arrow view appears in the assistance window.

Destination entry

In entering your destination you can select from among the following options:

- ▷ Entering a destination manually, see below
- ▷ Entering destination via voice*, refer to page 141
- ▷ Selecting destination using information, refer to page 144
- ▷ Selecting destination from a list, refer to Destination list, page 145
- ▷ Selecting destination from address book, refer to page 146
- ▷ Selecting home address, refer to page 148

After selecting your destination you can proceed to start the destination guidance, refer to page 150.

You can also store a navigation destination on the programmable memory/direct selection buttons, refer to page 21.

 Enter data only when the vehicle is stationary, and always give priority to the applicable traffic regulations in the event of any contradiction between traffic and road conditions and the instructions issued by the navigation system. If you do not observe this precaution, you can endanger the vehicle occupants and other road users.◀

Opening navigation system

iDrive, for operating principle refer to page 16.

1. Press the **MENU** button.
This opens the start menu.
2. Move the controller to the right to open "Navigation".



3. Select "Navigation" and press the controller.



The Control Display shows:

- ▷ the arrow view or map view during destination guidance
- ▷ the destination list when destination guidance is switched off

Entering a destination manually

The system's word matching principle makes it easier for you to enter the names of streets or towns/cities, refer to page 149. This allows you to enter different spellings and completes your entry automatically so that stored names can be called up quickly.

1. Change to upper field if necessary. Turn the controller until "Navigation" is selected and press the controller. "New destination" is selected.
2. Press the controller.



3. Select "Enter address" and press the controller.



The system also supports you with the following features:

- ▷ If you do not enter a street, the system will guide you to the downtown area of a town or city.
- ▷ You can skip the entry of country and town/city if the current entries should be retained for your new destination.

Selecting country

1. Select "State / Province" or the displayed country and press the controller.

The list of available countries appears on the display.



2. Select the country of destination and press the controller.

In order to be able to start the destination guidance, at least the town/city of the destination or its zip code must be entered.

Entering destination via town/city name

1. Select "Town / City" or the displayed town/city and press the controller.
2. Select the starting letter and press the controller. A list of all towns/cities starting with this letter appears on the Control Display.
3. To delete the letter entered if necessary:

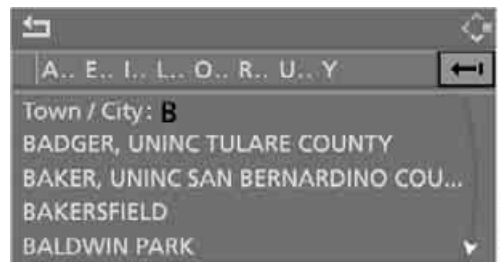

- ▷ Delete individual numbers or letters: Move the controller toward the right to select **←|** and press the controller.
- ▷ Delete all numbers or letters: Move the controller toward the right to select **←|** and press the controller longer.

- If necessary, enter more letters. The list gradually grows smaller each time you enter a new letter.
 - Enter blank space if necessary: Select the `_` symbol and press the controller.



- Change to the third field from the top if necessary. Turn the controller until the town/city name is selected from the list and press the controller.

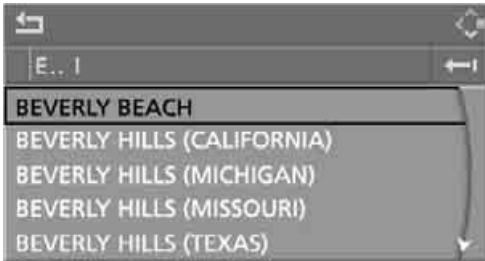

Entering destination via zip code

- Select "Town / City" and press the controller.
- Enter the zip code: Select the desired digits and press the controller.

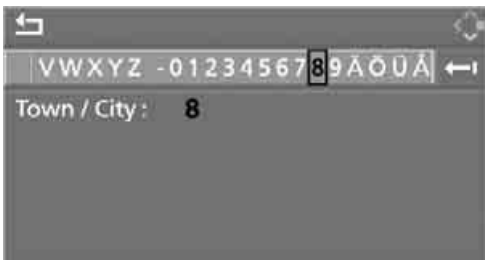

- Enter a blank space: Select the `_` symbol and press the controller.
- Delete individual numbers or letters: Move the controller toward the right to select `←|` and press the controller.
- Delete all numbers or letters: Move the controller toward the right to select `←|` and press the controller longer.

- Select the zip code and press the controller. The corresponding destination is displayed.
- Change into the third field from the top. Turn the controller until the destination is selected and press the controller.

Entering street, house number and intersection

After the street you can also enter the intersection or the house number.

Entering street and intersection

- Select "Street" or the displayed street and press the controller.
- Enter the street. The street is entered exactly like the destination.



The intersection is entered in the same way as the street.

Entering a street without entering a town/city of destination

You can also enter a street without entering a town/city of destination. In this case all streets of the entered country are offered for selection.

The related town/city is displayed after the street name.

If a town/city has already been entered, you can undo this entry. This may be practical if the desired street does not exist in the entered destination, because, for example, it belongs to another part of the town/city.

1. Change to upper field.
 The arrow is selected.



2. Turn the controller to the right until the request for the entry of a street in the country appears and press the controller.



3. Change to the second field from the top and enter the street.

Entering house number

All house numbers stored for the street on the navigation DVD can be entered.

1. Select "House number" and press the controller.
2. Enter the house number:
Select the desired digits and press the controller.
3. Change into the third field from the top.
Turn the controller until the house number is selected and press the controller.

Starting destination guidance with manual destination entry

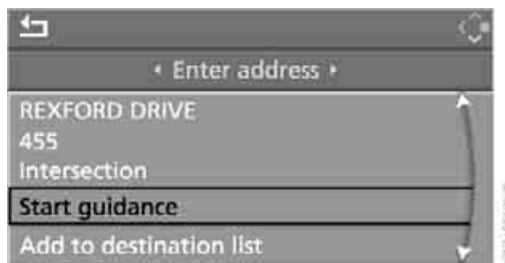

- ▷ Select "Start guidance" and press the controller.
Destination guidance starts immediately.
- ▷ If the destination guidance does not need to be started immediately:
Select "Add to destination list" and press the controller.
The destination is stored in the destination list, refer to page 145.

Entering destination via voice*

You can enter a desired destination with the voice command system. When entering the destination, it is possible to change between voice command and iDrive at any time. Reactivate the voice command system for this purpose if necessary.

- ▷ With ›Options‹ you can have the possible commands read aloud. ◀

1. Press the  button on the steering wheel.
2. ›Enter address‹



Selecting country

1. Wait for the system to ask for the country of destination.
2. Say the name of the country of destination.

Say the name of the country of destination in the language of the voice command system.

Entering destination

The destination can be spelled or entered as an entire word.

Spelling destination

To enter the destination, spell it using the orthography of the country of destination. Pronounce the letters smoothly and at normal volume, avoiding excessive emphasis and pauses.

1. Spell town/city name:
Say at least the first three letters of the destination. The more letters you say, the more exactly the system recognizes the town/city.

The system can suggest up to 20 destinations that match your entries. Up to 6 entries are displayed at once on the Control Display.



A destination is suggested by the system.

2. Select city/town:
 - ▶ Choose selected city/town: ›Yes‹
 - ▶ Select other city/town: ›No‹
 - ▶ Select entry, e.g. ›Entry 3‹
 - ▶ Display additional entries of the list: ›Next page‹
 - ▶ Spell the city/town again: ›Repeat‹

The town/city can also be selected from the list via iDrive:

Turn the controller until the destination is selected and press the controller.

Entering the destination as an entire word*

Towns/cities and streets located in the region where the language of the voice command system is spoken can be entered as an entire word.

Example: to enter a destination located in the US as an entire word, the language of the system must be English.

Speak smoothly and at normal volume, avoiding excessive emphases and pauses.

1. Wait for the system to request the destination.

2. Say the name of the destination.

The system can suggest up to 6 destinations that match your entries.



A destination is suggested by the system.

3. Select city/town:
 - ▶ Choose selected city/town: ›Yes‹
 - ▶ Select other city/town: ›No‹
 - ▶ Select entry, e.g. ›Entry 3‹
 - ▶ Enter city/town again: ›Repeat‹
 - ▶ Enter destination by spelling it: ›Spell‹

The town/city can also be selected from the list via iDrive:

Turn the controller until the destination is selected and press the controller.

▶ Destinations that sound the same which cannot be differentiated by the system are summarized in a separate list and shown as

a destination followed by three dots.
Select this entry with ›Yes‹ if necessary. Then select the desired city/town in this list. ◀

Entering street and house number

The street is entered in the same way as the destination.

To enter the house number:

1. ›House number‹
2. Say the house number.

Up to 4-digit house numbers can be entered.
Say the house number as individual numbers.

Starting destination guidance

1. ›Start guidance‹

Destination guidance starts immediately.

Saving destination

The destination is added to the destination list or can be stored in the address book.

1. ›Add to destination list‹ or
›Add to address book‹

Selecting destination via map

If you only know the location of the town/city or street of the destination, then you can enter the destination by using a map. You can use the cursor to select the destination on the map and then apply it in the destination guidance.

1. Select "Navigation" and press the controller.
"New destination" is selected.
2. Press the controller.



3. Select "Input map" and press the controller.

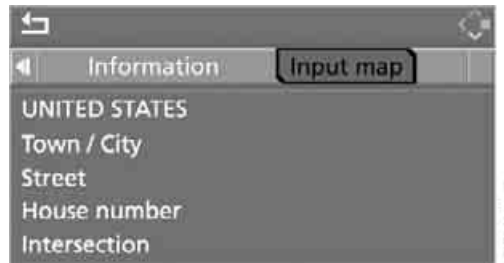

A section of a map is displayed on the Control Display:

- ▶ During destination guidance, around the current destination
- ▶ With the destination guidance deactivated, around the last destination entered



4. Select destination with cursor.
 - ▶ Changing scale: turn the controller.
 - ▶ Moving map: move the controller in the corresponding direction.
The controller can be moved to the left, right, forward and back.
5. To apply or store the destination in the destination guidance, press the controller.
The selected destination and other menu items are displayed.
6. Select the desired menu item:
 - ▶ "Start route guidance" starts destination guidance.
 - ▶ "Show current position" places the current position in the center of the map.
 - ▶ "Show destination position" places the current destination in the center of the map.

- ▷ "Return to map" changes back to the "Input map".
- ▷  Exit the menu.

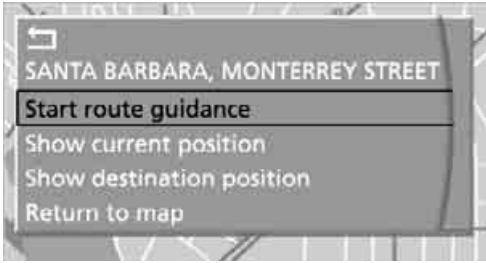

7. Press the controller.

The map for the destination entry can also be displayed in the map display:

Select the  symbol and press the controller.

Selecting destination using information

You can obtain a display of selected destinations, e.g. hotels, sights or hospitals, and apply them in the destination guidance.

1. Select "Navigation" and press the controller.
2. Select "Information" and press the controller.

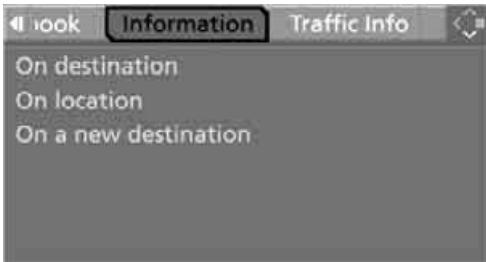

3. Select location:

- ▷ "On destination"
- ▷ "On location"
- ▷ "On a new destination"

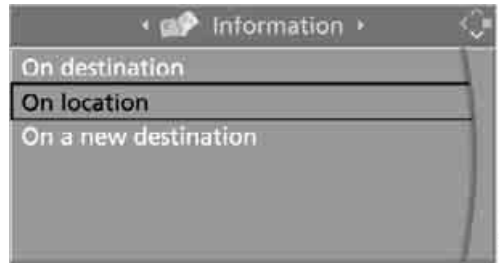



4. Press the controller.
5. Make your selection, e.g. "Hotels and restaurants", and press the controller.
6. Enter search criteria if necessary, e.g. the maximum distance from the current location.
7. Select "<Start search>" and press the controller.
These destinations are displayed on the Control Display.



8. Select a destination and press the controller.

 The scope of the information and symbols is dependent on the respective navigation DVD. ◀

9. Select the desired menu item:

- ▷ To apply the address in the destination list and start the destination guidance: Select the  symbol and press the controller.
- ▷ To establish a telephone connection: Select the  symbol and press the controller.
- ▷ To display additional destinations: Select the  symbol and press the controller.

- ▶ To start a new search:
Select the  symbol and press the controller.

To exit the menu:

 Select the arrow and press the controller.

Symbols in map view

If, for example, you have selected the category Hotels and have started the search, the hotels are shown on the map as symbols.

To hide the symbols in the map view:

1. Select the  symbol and press the controller.



2. Select "Hide map icons" and press the controller.

The symbols are hidden.

To display the symbols:

Select "Show map icons" and press the controller.

To exit the menu:

 Select the arrow and press the controller.

Destination list

The last 20 entered destinations are shown in the destination list. You can display these destinations and apply them in the destination guidance.

For example, to plan a longer route, you can store all destinations you want to drive to in advance in the destination list, refer to Entering a destination manually on page 139.

Select "Navigation" and press the controller.



The last destination entered is the first item in the destination list.

 This symbol indicates the current destination during destination guidance.

To display additional destinations from the destination list:

Turn the controller.

Applying destination in destination guidance

1. Select the desired destination and press the controller.
2. Select "Start guidance" and press the controller.

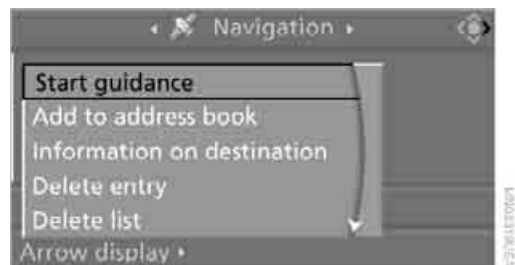

Editing destination list

1. Select the desired destination in the destination list and press the controller.
2. The selected destination can be edited:
 - ▶ Store entry:
Select "Add to address book".
 - ▶ Display information on destination:
Select "Information on destination".
 - ▶ Delete entry:
Select "Delete entry".

- ▷ Delete all entries:
Select "Delete list". The destination guidance is switched off.
- ▷ Change entry:
Select "Edit". For operation, refer to Entering destination via town/city name, page 139.

3. Press the controller.

Address book

Opening address book

iDrive, for operating principle refer to page 16.

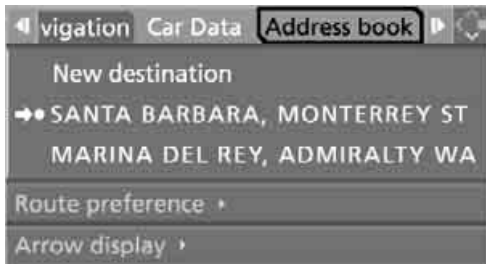

Select "Address book" and press the controller.

Storing destinations in address book

You can store approx. 100 destinations in the address book.

1. Select "Address book" and press the controller.
2. Select "New address" and press the controller.

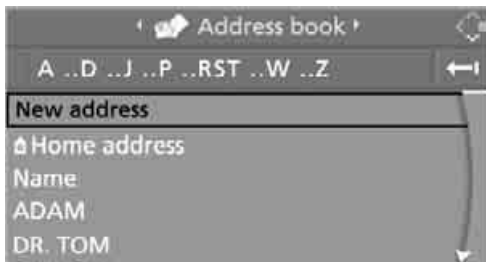

3. Select "Enter address" and press the controller.

4. Enter name and address, also refer to Entering a destination manually, page 139.
5. Select "Store in address book" and press the controller.
The entry is stored in the address book.

You can also store a destination from the destination list into the address book, refer to page 145.

Storing current position*

The current position can be applied in the address book.

1. Select "Address book" and press the controller.
2. Change into the third field from the top. Turn the controller until "New address" is selected and press the controller.

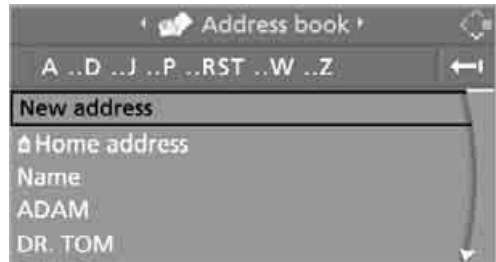

3. Select "Use current location as address" and press the controller.
The name given can be changed. For operation, refer to Entering a destination manually, page 139.
4. Select "Store in address book" and press the controller.

You can also apply your current position in the address book if you have left the sector covered by the navigation DVD. In this case, you must enter a name.

Selecting destinations from address book

1. Select "Address book" and press the controller.
The stored entries appear on the Control Display.



2. Select the entry and press the controller.
To start the destination guidance:
Select "Start guidance" and press the controller.

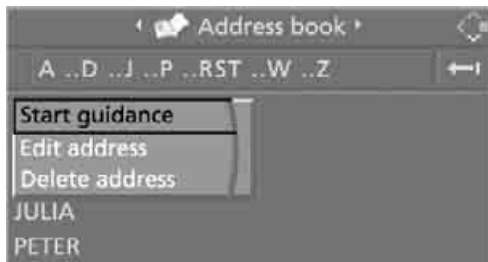

Changing destinations from address book

1. Select "Address book" and press the controller.
2. Select the entry and press the controller.
3. Select "Edit address" and press the controller.

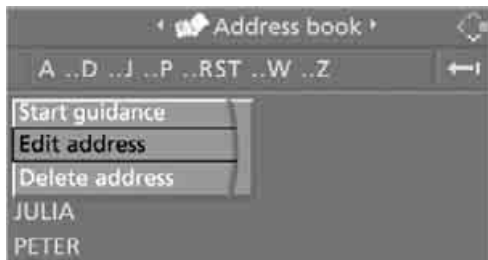

4. Change entry.
For operation, refer to Entering a destination manually, page 139.
5. Select "Store in address book" and press the controller.

Deleting individual destinations from address book

1. Select "Address book" and press the controller.
2. Select the entry and press the controller.
3. Select "Delete address" and press the controller.

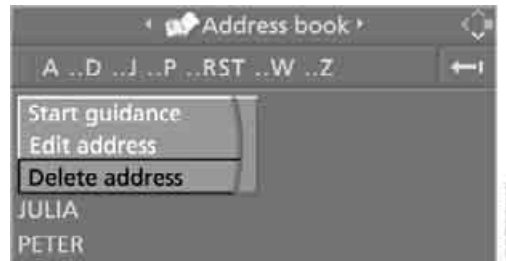

Deleting all destinations from address book

1. Open the start menu.
2. Press the controller to open the **i** menu.
3. Select "Settings" and press the controller.
4. Select "Vehicle / Tires" and press the controller.
5. Change to upper field if necessary. Turn the controller until "Delete data" is selected and press the controller.



6. Select "Delete address book" and press the controller.
7. Select "Yes" and press the controller.

Home address

You can store your current position or the current destination as the home address in the address book. This entry occupies the second position in the address book.

Storing home address

1. Select "Address book" and press the controller.
2. Change into the third field from the top. Turn the controller until "Home address" is selected and press the controller.

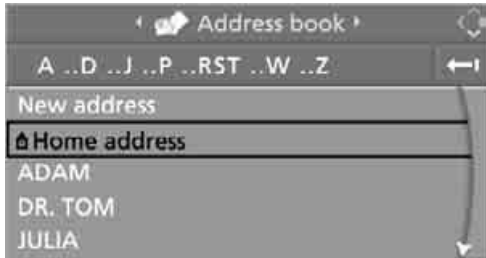

3. Select "Use current location as address", or "Save current destination" during the destination guidance, and press the controller.
4. Select "Store in address book" and press the controller.

Applying home address as destination

1. Select "Home address" and press the controller.
2. Select "Start guidance" and press the controller.

Changing home address

1. Select "Home address" and press the controller.
2. Select "Edit address" and press the controller. For operation, refer to Entering a destination manually, page 139.

Selecting route

You can influence the calculated route by choosing certain route criteria. You can change the route criteria as often as you like while entering the destination and whenever the destination guidance is active.

The route is planned according to fixed rules. The road type is taken into account, e.g. whether it is a highway or a winding road. The road types are stored on the navigation DVD. As a result, the routes recommended by the navigation system may not always be the same ones that you would choose based on personal experience.

Changing route criteria

1. Select "Navigation" and press the controller.
2. Change into the third field from the top. Turn the controller until "Route preference" is selected and press the controller.

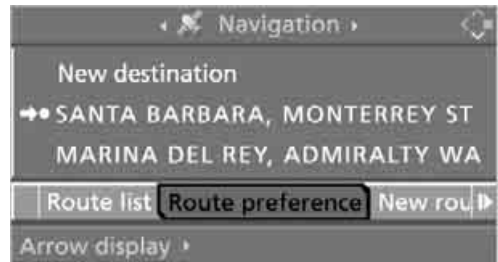

The various criteria are listed on the Control Display.

3. Select a route criterion for the route:
 - ▷ "With highways"
Freeways and major traffic arteries are given priority
 - ▷ "Avoid highways"
Freeways are avoided where possible
 - ▷ "Fast route"
The short traveling time, being a combination of the shortest possible route and the fastest roads
 - ▷ "Short route"
Short route, irrespective of how fast or slow progress will be

4. Press the controller.



 The route criterion is highlighted.

5. If necessary, select an additional route criterion and then press the controller:
 - ▷ "Dynamic route"*
Automatic changing of the route in case of traffic obstructions. Depending on road type and the kind and extent of the traffic obstruction, the route can also be calculated so that you travel through the traffic obstruction.
 - ▷ "Avoid tollroads"
Tollroads are avoided where possible.
 - ▷ "Avoid ferries"
Ferries are avoided where possible.

To exit the menu:

 Select the arrow and press the controller.

The route criteria can also be changed in the arrow or map display.

1. Select the symbol for the route criterion and press the controller.
2. Select a route criterion and press the controller.

 If the route criteria "Avoid highways", "Avoid tollroads" or "Avoid ferries" are selected, the calculation time for the route can increase considerably. ◀

Word matching principle

The system supports the word matching principle to make it easier for you to enter the names of streets or towns/cities. The system runs ongoing checks, comparing your destination entries with the data stored on the navigation DVD as the basis for instant response. The user benefits include:

- ▷ Names of specific locations can also vary from the official versions if you are using a spelling that is customary in another country.

Example:

Instead of "München", you can also enter the English spelling "Munich" or the Italian spelling "Monaco".

- ▷ When you are entering the names of towns/cities and streets the system will complete them automatically as soon as enough letters are available to ensure unambiguous identification.
- ▷ The system only accepts name entries beginning with letters that are stored on the navigation DVD. The system will not accept non-existent names and addresses.

Destination guidance

Starting destination guidance

Via iDrive

iDrive, for operating principle refer to page 16.

1. Change to upper field if necessary. Turn the controller until "Navigation" is selected and press the controller.
2. Select a destination from the destination list and press the controller or enter a new destination, refer to page 138.



3. Select "Start guidance" and press the controller.

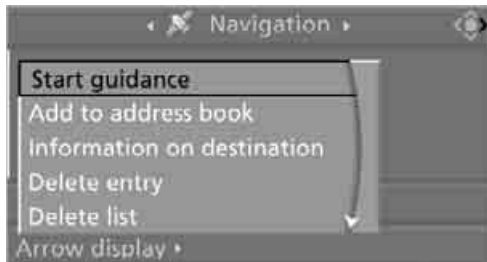

After the route has been calculated, destination guidance is indicated by arrows or a map display on the Control Display.



The destination guidance can also be started in the arrow or map view:

Select the  symbol and press the controller.

During destination guidance, you can operate other equipment via iDrive at any time. You will be punctually notified of a change of direction

by spoken instructions and the display of the direction arrow.

With programmable memory/ direct selection buttons

Press the  ...  button on which the desired destination is stored, also refer to page 22.

Ending/continuing destination guidance

In arrow or map display

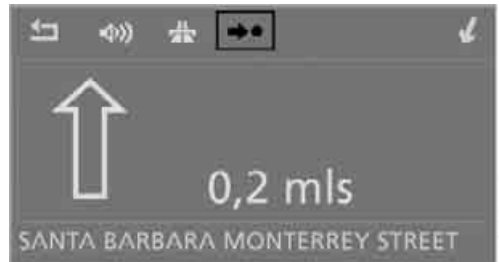

Select the  symbol and press the controller.

In destination list

 This symbol indicates the current destination.

1. Select the current destination and press the controller.



2. Select "Stop guidance" and press the controller.

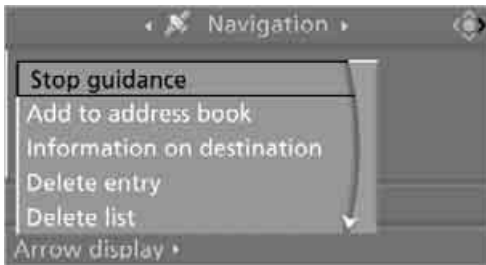

When you park the vehicle before reaching the entered destination, the following question is displayed before beginning the next trip: "Continue guidance to destination?".

The destination guidance starts automatically after a short time.

To start the destination guidance: Select "Yes" and press the controller.

Displaying route

You have the option of displaying various views of the route during destination guidance.

▶ From another menu, you can change directly to the screen last displayed, refer to Comfort opening of menu items on page 18. ◀

Displaying arrow display

1. Select "Navigation" and press the controller.
2. Change into the fourth field from the top. Turn the controller until "Arrow display" is selected and press the controller.

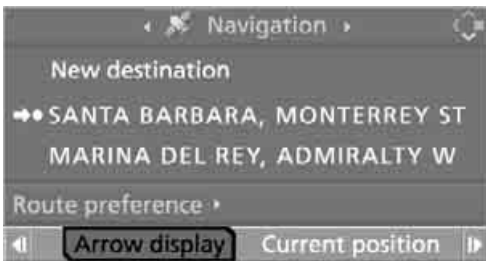

The arrow display is shown.



- 1 Switching voice instructions on/off
- 2 Selecting route criteria
- 3 Starting/ending destination guidance
- 4 Arrow to destination from a bird's eye view
- 5 Distance to the next change of direction
- 6 Current position
- 7 Direction of travel

- ▶ Outline arrow: Destination guidance on the calculated route
- ▶ Solid arrow: Arrow shows the route to be calculated from a bird's eye view when the vehicle is not located in an area contained on the navigation DVD, e.g. in a multi-level parking lot.

Depending on the equipment, the estimated time of arrival and the distance to the destination are displayed in the top or bottom line of the Control Display.

Before a change in direction, the representation of the arrow changes.

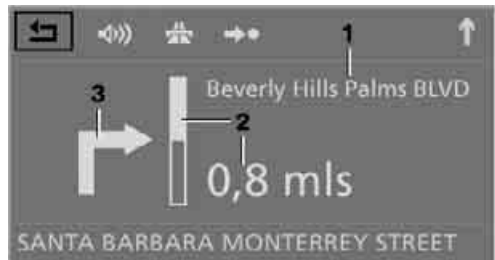

- 1 Street name for change of direction
- 2 Distance up to change of direction
- 3 Change of direction

To exit the menu:

 Select the arrow and press the controller.

Displaying map view

You can have your current position displayed on a map. After starting the destination guidance, the planned route is shown on the map.

1. Select "Navigation" and press the controller.
2. Change into the fourth field from the top. Turn the controller until the desired map view is selected:
 - ▷ "Map facing north"
 - ▷ "Map direction of travel"
 - ▷ "Perspective"

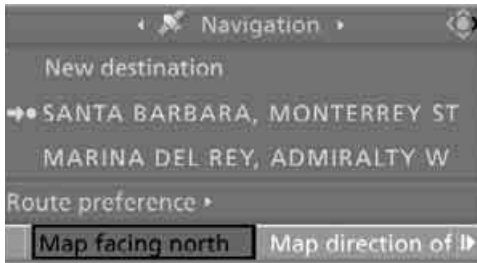



3. Press the controller.



- 1 Switching voice instructions on/off
- 2 Starting/ending destination guidance
- 3 Selecting destination via map
- 4 Displaying the menu in which the information last selected can be displayed/hidden, refer to Selecting destination using information, page 144

- 5 Changing map display

- ▷  "Map facing north"
- ▷  "Map direction of travel"
- ▷  "Perspective"

- 6 Changing route criteria

- 7 Manually displaying traffic information*

- 8 Arrow to destination from a bird's eye view

The estimated time of arrival and the distance to the destination are shown in the bottom line of the Control Display.

To exit from the menu:

 Select the arrow and press the controller.

At scales of less than 250 miles/500 km, you have the option of deciding whether to orient the map to north, toward your current direction of travel, or show the map in perspective. At scales of 250 miles/500 km or greater, the map always points toward north.

Changing map display



Select the corresponding symbol and press the controller.

The next map display is displayed.

Changing scale

Turn the controller to change the scale.

Displaying roads and towns/cities of route

You can have the roads and towns/cities along the route displayed during destination guidance.

The distances remaining to be traveled on each individual route are also displayed.

1. Select "Navigation" and press the controller.
2. Change into the third field from the top. Turn the controller until "Route list" is selected and press the controller.

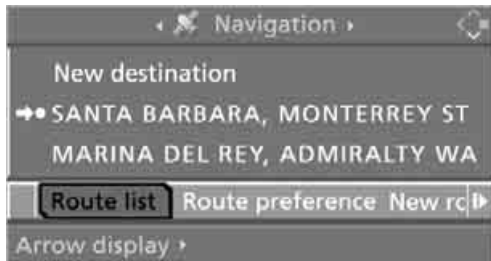

To exit the menu:

- ➡ Select the arrow and press the controller.

Destination guidance via voice instructions

Switching voice instructions on/off

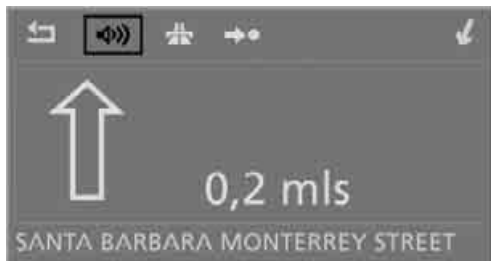

Voice instructions can be switched on or off during the destination guidance in the arrow or map view:

Select the  symbol and press the controller.

To switch the voice instructions on and off at any time:

1. Press the **MENU** button. This opens the start menu.
2. Press the controller to open the **i** menu.

3. Turn the controller until "Settings" is selected and press the controller.



4. Turn the controller until "Language / Units" is selected and press the controller.
5. Change to upper field if necessary. Turn the controller until "Languages" is selected and press the controller.

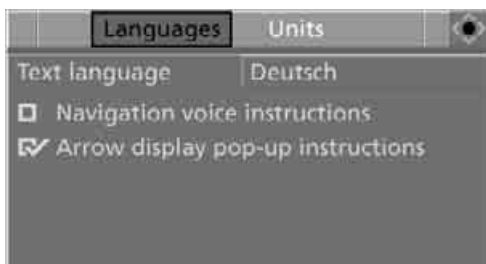

6. Select "Navigation voice instructions" and press the controller.

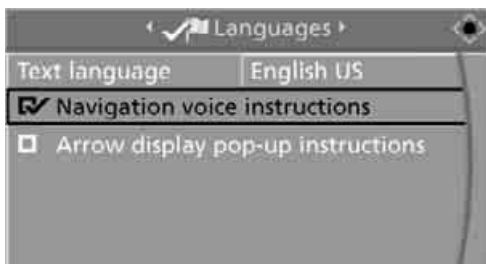

- ✔ The voice instructions are switched on.

Repeating and canceling voice instructions

With the programmable buttons on the steering wheel you can also make the following settings, refer to page 53:

- ▷ Repeat the voice instruction:
Press the button.
- ▷ Switch voice instructions on/off:
Hold the button down.

Setting volume of voice instructions

The volume can only be adjusted while a voice instruction is being output.

1. Repeat the last voice instruction, if necessary.
2. Turn the button during the voice instruction to select the desired volume.



This volume is independent of the volume of the audio sources.

The setting is stored for the remote control currently in use.

Changing route

During destination guidance, you can revise the navigation system's route recommendations to avoid particular stretches of road. Enter the number of miles/kilometers that you want to travel before returning to the original route.

1. Select "Navigation" and press the controller.
2. Change into the third field from the top. Turn the controller until "New route" is selected and press the controller.

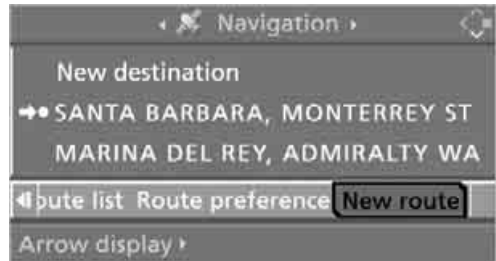

3. Turn the controller to enter the desired number and press the controller.

The route is recalculated.

To exit from the menu without changing the route:

- ↩ Select the arrow and press the controller.

Traffic information*

In many congested areas, you can receive traffic information transmitted by radio stations. The traffic conditions are monitored by traffic management centers and the traffic information is periodically updated.

During destination guidance, the traffic information relevant to your planned route is automatically displayed and, if you wish, taken into account in the route planning. Whether destination guidance is active or not, you can have the traffic information displayed in the map view or in the traffic info list.

Switching reception of traffic information on/off

iDrive, for operating principle refer to page 16.

1. Press the **MENU** button.
This opens the start menu.
2. Press the controller to open the **i** menu.
3. Turn the controller until "Settings" is selected and press the controller.



4. Turn the controller until "Traffic Info settings" is selected and press the controller.

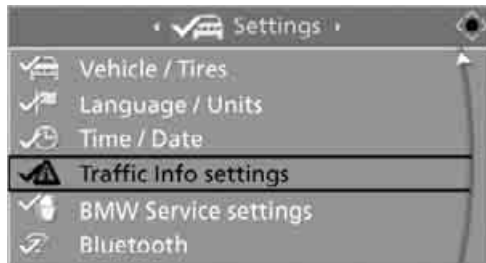

5. Select "Traffic Info" and press the controller.

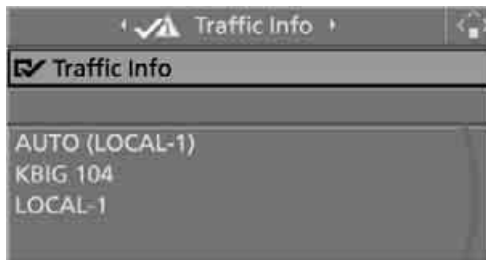

The traffic information can be received and displayed.

"AUTO": automatic selection of the Traffic Info station with the strongest reception.

 Depending on the station, either the station name, frequency, local number or other information is displayed. ◀

Manually displaying traffic information

During destination guidance

During destination guidance, traffic information can be displayed in the arrow or map view.

If the  symbol is shown with a red border, traffic information is available for the planned route.

Select the  symbol and press the controller.

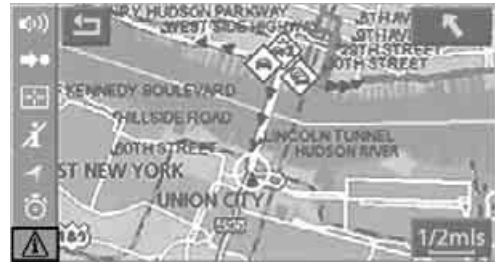

During destination guidance, the traffic information on the planned route is marked with a yellow diamond.

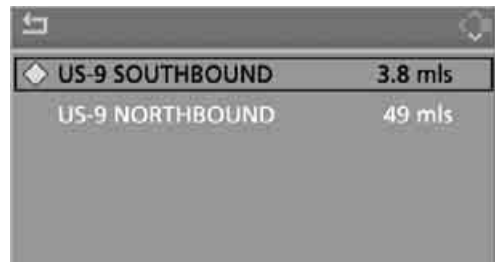

First the traffic information along the planned route is shown sorted according to the distance to the current vehicle position.

With destination guidance switched off

1. Open the start menu.
2. Move the controller to the right to open "Navigation".
3. Select "Traffic Info" and press the controller.

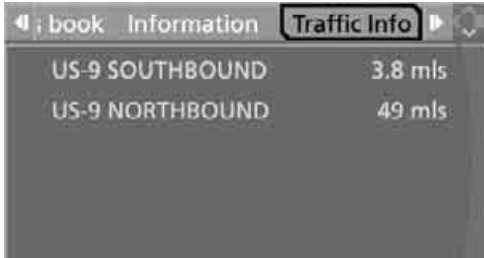

First the traffic information along the planned route is shown sorted according to the distance to the current vehicle position.

Depiction of traffic information in map view

The traffic information symbols are shown in the map view up to a scale of 100 miles/200 km. The section of the route affected by a traffic report as well as the indication for the type of incident, which will be described below, are displayed and hidden. This occurs as a function of the scale selected.

Displaying detailed traffic information

Select traffic information from the displayed list and press the controller.



To exit from the menu:

- ← Select the arrow and press the controller.

Symbols for traffic information

- Traffic event with map scales greater than 5 miles/10 km, arrow points in the direction of travel concerned
- Several traffic events have been received. Select a smaller scale to display these individually.
- Traffic light failure
- Roadwork
- General traffic obstruction
- Transport of hazardous load
- Vehicle on wrong carriage way
- Danger
- Low clearance
- No parking
- Fog
- Heavy rain
- Slippery road
- Cross winds
- Smog
- Road closed
- Slow traffic
- Traffic back up
- Stopped traffic
- Icy roads
- Uneven surface
- Accident

 Lane closure

 Delay

 Police checkpoint



 Slow traffic or other traffic event

 Stop-and-go traffic

 Stopped traffic

 Traffic event in both directions of travel

Traffic information during destination guidance

System response will vary depending on whether or not "Dynamic route" is selected, refer to page 148.

Displaying traffic obstructions

If a traffic obstruction is reported to the navigation system and "Dynamic route" is not selected, then you will be provided with certain information from a distance of approx. 25 miles/ 40 km, e.g. the length of the traffic jam. The last possible junction will be displayed shortly before this.



Select "Detour" and press the controller. The navigation system determines a new route to bypass the traffic congestion.

This information is displayed even if you have activated a different function on the Control Display.

Dynamic route planning

When "Dynamic route" is selected, the route will be changed automatically in the event of a traffic obstruction. The system does not point out traffic obstructions along the original route. Depending on road type and the kind and extent of the traffic obstruction, the calculated route may nevertheless lead through the traffic obstruction.

Displaying current position

You can have your current position displayed even when the destination guidance is switched off.

1. Select "Navigation" and press the controller.
2. Change into the fourth field from the top. Turn the controller until "Current position" is selected and press the controller.

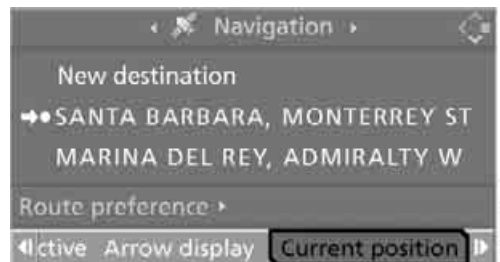

The current position of your BMW is displayed.

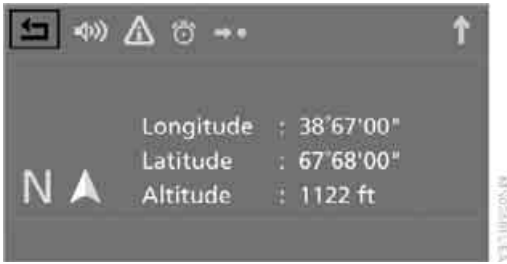

If the navigation system is unable to identify a town or city, your current map coordinates will appear.

To exit the menu:

☞ Select the arrow and press the controller.

You can also have the current position displayed on a map, refer to page [152](#).

What to do if ...

What to do if ...

- ▷ a navigation DVD is inserted, but an instruction to insert the DVD appears on the Control Display?
The navigation DVD may not be the correct DVD for the navigation system. This information is indicated on the DVD label.
- ▷ you request the current position of your vehicle, but do not receive a precise display?
The system is unable to receive enough GPS signals at your current position due to obstructions, your position is not yet available on your navigation DVD, or the system is in the process of calculating your position. Reception is best when you have an unobstructed view to the sky.
- ▷ the destination guidance does not accept a destination?
The data of the destination is not stored on the navigation DVD that is loaded. Select a destination that is as close as possible to the original.
- ▷ the destination guidance does not accept an address without the street name?
On the navigation DVD, no downtown area can be determined for the city or town entered. Enter any street, or a destination such as the railway station in the selected town, and then start the destination guidance.
- ▷ you want to enter a destination for the destination guidance, but it is not possible to select the letters for your desired entry?
The data of the destination is not stored on the navigation DVD that is loaded. In this case, the system will not offer you any letters to choose from. Select a destination that is as close as possible to the original.

- ▷ the system stops furnishing directions on which way to turn as you approach intersections?
You are driving in an area that has not yet been completely recorded on the navigation DVD. Instead of an arrow indicating a turn, you will see an arrow which indicates the general direction of your planned route. Or you have left the recommended route and the system requires a few seconds to calculate a new recommended route.
- ▷ the navigation system does not react to entries?
If the battery was disconnected, it takes about 10 minutes before the system is once again operational.





Entertainment

Operation of the radio and CD as well as their tone settings are described in this chapter.

On/Off and settings

The following audio and video sources have common controls and adjustment options:

- ▷ Radio
- ▷ CD player
- ▷ CD changer*

Controls



The audio and video sources can be operated with:

- ▷ Buttons in the area of the CD player
- ▷ iDrive
- ▷ Buttons on steering wheel, refer to page 11
- ▷ Programmable memory/direct selection buttons, refer to page 21

Buttons on CD player

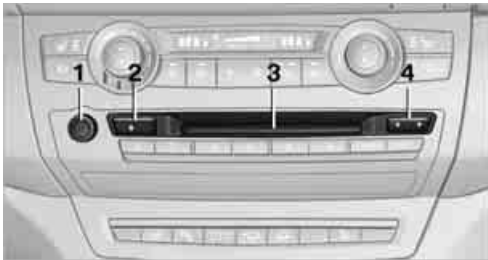

Equipment with a single drive

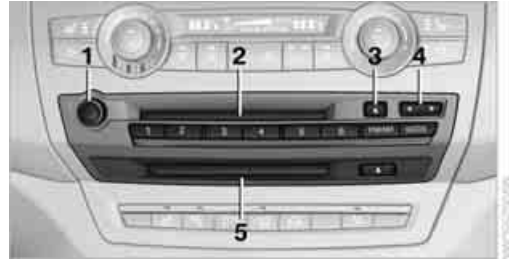

- 1 Entertainment sound output on/off, volume
 - ▷ Press: switch on/off.
When the system is switched on, the most recently selected radio station or CD track is played.
 - ▷ Turn: adjust volume.
- 2  Eject CD.
- 3 Drive for audio CDs
- 4  Station scan/track search
 - ▷ Change radio station.
 - ▷ Select track for CD player and CD changer.

Equipment with two drives



- 1 Entertainment sound output on/off, volume
 - ▷ Press: switch on/off.
When the system is switched on, the most recently selected radio station or CD track is played.
 - ▷ Turn: adjust volume.
- 2 Drive for audio CDs
- 3  Eject CD.
- 4  Station scan/track search
 - ▷ Change radio station.
 - ▷ Select track for CD player and CD changer.
- 5 Drive for navigation DVDs

Operation via iDrive

iDrive, for operating principle refer to page 16.

1. Press the **MENU** button.
This opens the start menu.
2. Move the controller backwards to open "Entertainment".



You have the following choices:

- ▷ "FM" and "AM": radio reception
- ▷ "WB": Weather Band station
- ▷ "SAT": satellite radio*
- ▷ "CD": CD player or changer
- ▷ "AUX": AUX-In connection, USB audio interface
- ▷ "Set": depending on the audio source, other adjustments can be made, e.g. with the radio: update station with strongest reception, store station, tone control, sample stations.

 From another menu, you can change directly to the screen last displayed, refer to Comfort opening of menu items on page 18. ◀

From radio readiness, the selected audio source is stored for the remote control currently in use.

Switching on/off

To switch the Entertainment sound output on and off:

Press knob **1** on the CD player.

 This symbol on the Control Display indicates that sound output is switched off.

For equipment with a single drive, the sound output is available for approx. 20 minutes with the ignition switched off.

Switch on the sound output again for this purpose.

Adjusting volume

Turn knob **1** on the CD player until the desired volume is set.

You can also adjust the volume with buttons on the steering wheel, refer to page 11.

From radio readiness, the setting is stored for the remote control currently in use.

Tone control

You can alter various tone settings, e.g. treble and bass, or the speed-dependent volume increase.

The tone settings are set for all audio sources at once.

From radio readiness, the settings are stored for the remote control currently in use.

Changing tone settings

1. Press the **MENU** button.
This opens the start menu.
2. Press the controller to open the **i** menu.
3. Turn the controller until "Settings" is selected and press the controller.
4. Select "Audio" or "Tone / Volume" and press the controller.



The tone settings can also be selected when you have opened "Entertainment" in the start menu:

Select "Set" and then "Tone", and press the controller.

Treble and bass

1. Select "Treble / Bass" and press the controller.



2. Move the controller to the left or right to select "Treble" or "Bass".



3. Turn the controller until the desired setting is selected.

Balance and fader

You can adjust the volume distribution in the same manner as "Treble / Bass".

- ▷ "Balance": left/right volume distribution
- ▷ "Fader": front/rear volume distribution

Speed-dependent volume control

The speed-dependent volume control automatically increases the volume with increasing speed. You can set various stages for the increase in volume.

When equipped with two drives:

1. Select "Speed volume" and press the controller.



2. Turn the controller: The adjustment is applied; the field can be changed.



When equipped with a single drive:

1. Select "Volume settings" and press the controller.
2. Change to the second field from the top if necessary. Select "Speed volume" and press the controller.



3. Turn the controller: The adjustment is applied; the field can be changed.



Professional HiFi System*

You can choose between stereo and multi-channel playback, surround.

1. Select "Surround Settings" and press the controller.

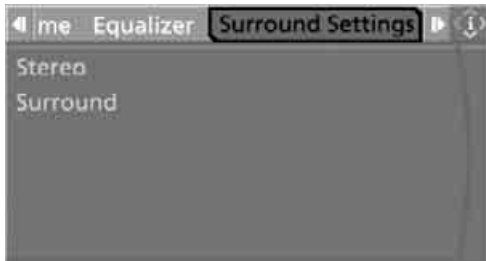

2. Select "Stereo" or "Surround".

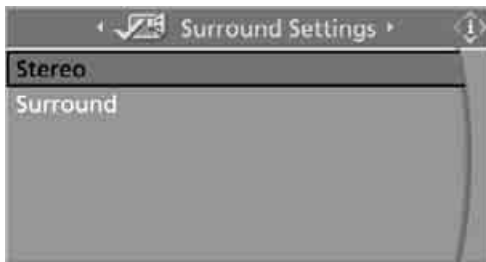

3. Press the controller.
The spatial sound effect is activated.

Equalizer*

You can set individual sound frequency ranges.

1. Select "Equalizer" and press the controller.



2. Move the controller to the left or right to select the desired frequency range.

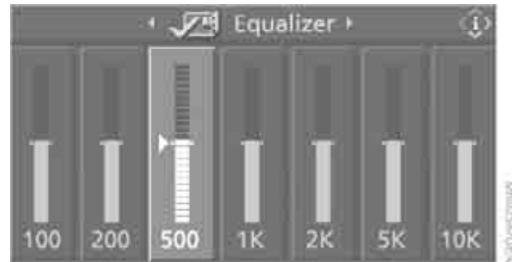

3. Turn the controller until the desired setting is selected.

Resetting tone settings

You can reset all tone settings to the default settings.

1. Open the start menu.
2. Press the controller to open the **i** menu.
3. Turn the controller until "Settings" is selected and press the controller.
4. Select "Audio" and press the controller.
5. Change to upper field if necessary. Turn the controller until "Reset" is selected and press the controller.



6. When equipped with two drives:
Select "Yes" and press the controller.

Radio

Your radio provides reception of the FM and AM wavebands.

Listening to radio



Press the knob if the sound output is switched off.

iDrive, for operating principle refer to page 16.

1. Press the **MENU** button.
This opens the start menu.
2. Move the controller backwards to open "Entertainment".
3. Change to upper field if necessary. Select "FM" or "AM".



4. Press the controller.

Stations are shown on the Control Display on the basis of various selection criteria, e.g. "Presets".

If "Autostore" does not display any stations or if the stations displayed can no longer be received in the AM reception range, to update the station with the strongest signal, refer to page 167.

Changing stations



Turn the controller.

Buttons on CD player

Press the  button for the corresponding direction.

The system changes to the next displayed station.

You can also change stations with the buttons on the steering wheel, refer to page 11.

Changing selection criteria

In addition to the stations currently displayed, you can have stations with another selection criterion displayed.

You can choose from the following selection criteria:

- ▷ "All stations"*:
Stations that can currently be received in the "FM" waveband.
- ▷ "Autostore":
The stations with the strongest received signals in the "AM" waveband.
With High Definition Radio: the stations with the strongest received signals in the "FM" waveband.
- ▷ "Presets":
Stations you have previously stored, refer to page 168.
- ▷ "Manual":
To set stations that can be received in addition to those displayed, refer to Manually selecting frequency on page 167.

To change the selection criterion:

1. Change into the second field from the top.
2. Select the selection criterion and press the controller.



Sampling stations, scan

The system automatically plays a brief sample from each of the stations on the current waveband.

1. Select "FM" or "AM" and press the controller. "Set" is selected.
2. Press the controller. Other menu items are displayed.
3. Select "Scan" and press the controller.



The stations are sampled.

To end sampling:

1. Press the controller.
2. Select "Scan" and press the controller.

This cancels sampling of the stations, and the radio remains on the current station.

Buttons on CD player

To sample the stations, press and hold the  button for the corresponding direction.

To end scanning, press the button again.

Selecting frequency manually

With "Manual" you can select stations that can be received in addition to those displayed.

1. Select "FM" or "AM" and press the controller.
2. Change into the second field from the top.
3. Select "Manual" and press the controller.



4. Turn the controller to set a certain frequency.

Updating stations with best reception

If you are on a longer journey and leave the transmission range of the stations originally set, you can update the list of stations in the AM range with the best reception.

1. Select "AM" and press the controller.
2. Change into the second field from the top.
3. Select "Autostore" and press the controller. "Set" is selected.



4. Press the controller. Other menu items are displayed.

5. Select "Autostore" and press the controller.



The display of the stations with the strongest reception is updated. The frequencies of the stations are displayed.

Storing stations

Via iDrive

1. Select "FM" or "AM" and press the controller.
2. Change into the second field from the top. Turn the controller until the desired selection criterion is selected and press the controller.
3. Select the desired frequency or station. "Set" is selected.



4. Press the controller.
Other menu items are displayed.

5. Select "Store" and press the controller.

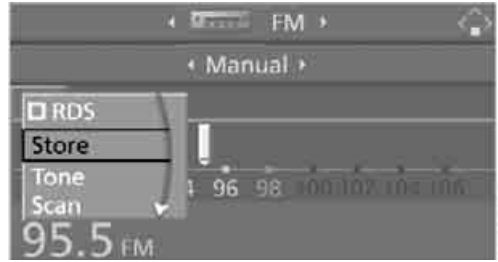

"Presets" is displayed.

6. Turn the controller until the desired memory position is selected.
7. Press the controller.
The station is stored.



The stations of the last selection criterion are displayed once again after a short time.

From radio readiness, the stations are stored for the remote control currently in use.

With programmable memory/ direct selection buttons

You can also store a station on the programmable memory/direct selection buttons, also refer to page 21.

1. Select a station.
2.  ...  Press and hold the desired button.

Changing a memory position

1. Select "Presets" and press the controller.
2. Select the desired station.
"Set" is selected.
3. Press the controller.
Other menu items are displayed.

4. Select "Store" and press the controller.



5. Turn the controller until the desired memory position is selected.
The number of the memory position appears beside the name or frequency of the station.
6. Press the controller.
The station is stored.

RDS Radio Data System

In the FM frequency range, additional information is transmitted via RDS. If the reception conditions are good, the station names are shown on the Control Display. If the reception is weak or disrupted, it can take some time before the station names are displayed.

Switching RDS on/off*

1. Select "FM" and press the controller.
"Set" is selected.
2. Press the controller.
Other menu items are displayed.
3. Select "RDS" and press the controller.



RDS is activated.

The setting is stored for the remote control currently in use.

High Definition Radio*

Many stations transmit both analog and digital signals. You can receive these stations digitally and with improved sound quality.

A digital radio network must be available in order to receive digital stations.

Activating/deactivating digital radio reception

iDrive, for operating principle refer to page 16.

1. Press the **MENU** button.
This opens the start menu.
2. Press the controller to open the **i** menu.
3. Turn the controller until "Settings" is selected and press the controller.
4. Select "Audio" and press the controller.
5. Change to upper field. Turn the controller until "HD radio" is selected and press the controller.



6. Select "Off" and press the controller.
 The reception of digital stations is activated.
HD This symbol is displayed when a station is being received digitally.



With some stations the digital signals are not transmitted simultaneously with the analog signals. If you are in an area in which the selected station is not continuously received digitally, playback changes between analog and digital reception. This can result in repetitions or interruptions. In this case it may be advisable to deactivate digital radio reception.

Selecting programs of a digital station*

Some stations transmit several programs on one frequency. To select one of these programs:

1. Select "FM" or "AM" and press the controller.

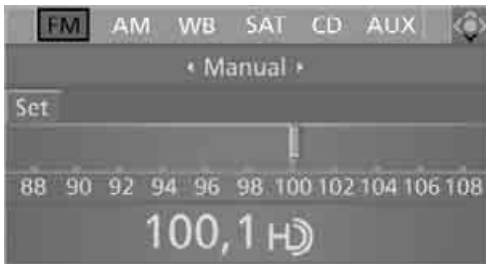

2. Select "Manual" and press the controller.
3. Select a station that is received digitally. HD This symbol is displayed when a station is being received digitally.
4. Switch to the next program of the digital station with the ◀ ▶ buttons on the radio or the steering wheel.

You can store a station, refer to page 168.

Updating stations offering digital reception

If you are on a longer journey and leave the transmission range of the stations originally set, you can update the list of stations with the best reception.

1. Select "FM" or "AM" and press the controller.



2. Change into the second field from the top.
3. Select "Autostore" and press the controller.



4. Press the controller. Other menu items are displayed.
5. Select "Autostore HD" and press the controller.



The display of the stations offering digital reception is updated. This can take up to 2 minutes.

Displaying additional information

With the digital stations, additional information on the current track is displayed, e.g. the name of the artist.

1. Select a station and press the controller.
2. Select "Details" and press the controller.



 The information is displayed.



If a digital station is received again when the station is changed, the additional information will be displayed again following a brief interruption.

Weather news flashes*

Weather Radio is a service of the National Oceanic and Atmospheric Administration (NOAA) of the US Department of Trade. Weather news flashes are repeated every four to six minutes and are routinely updated at intervals of one to three hours, and more often when necessary. Most stations operate 24 hours a day. In case of a storm, the National Weather Service interrupts the routine weather news and transmits special warning messages instead. If you have a question about NOAA Weather Radio, please contact the nearest office of the National

Weather Service. Details are also provided on the Internet at www.nws.noaa.gov.

Calling up weather news flashes

1. Select "WB" and press the controller.



2. Select a station.

The station for weather news flashes may be unavailable in some regions.

Satellite radio*

You can receive over 100 different channels with high sound quality.

The channels are offered to you in predefined packages. To receive the channels of your choice, you must have this package enabled.

 With this new technology the signal may fail, causing interruptions in reception. ◀

Enabling or disabling channels

iDrive, for operating principle refer to page 16.

1. Press the **MENU** button.
This opens the start menu.
2. Move the controller backwards to open "Entertainment".
3. Select "SAT".



4. Press the controller.

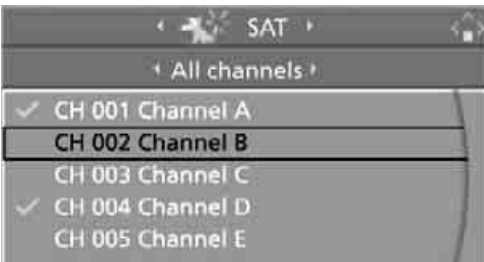

The channels are displayed.

✔ These channels are enabled.

Enabling

1. Select a channel that has not yet been enabled and press the controller.
A telephone number and the electronic serial number, ESN, are displayed.

 The electronic serial number is required for enabling or disabling. ◀

2. To enable the channels:
Dial the phone number.

Disabling

1. Select an enabled channel and press the controller.

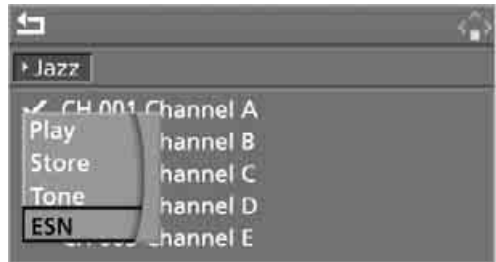

2. Select "ESN" and press the controller.
The electronic serial number, ESN, is displayed.

 The electronic serial number is required for disabling. ◀

3. To disable the channels:
Dial the phone number.

Selecting and storing channel

1. Select "SAT" and press the controller.



Channels or categories appear in the Control Display.

2. Select a menu item:
 - ▷ "Presets":
Up to twelve channels you have stored previously.
 - ▷ "All channels":
All channels are displayed.
 - ▷ "Categories":
All channels, sorted by categories, e.g. news, jazz.

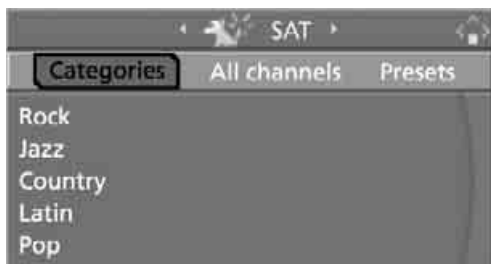

3. Press the controller.
4. If "Categories" has been selected:
Select the desired category and press the controller.

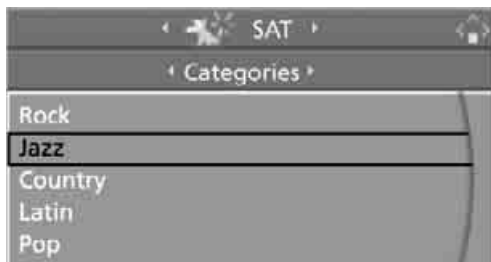

The channels of this category are displayed.

5. ✓ Select a channel marked with this symbol.

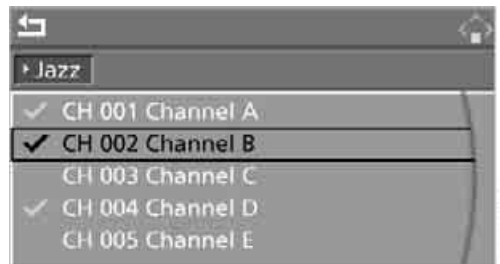

6. Press the controller.
Other menu items are displayed.
7. Select "Play" and press the controller.

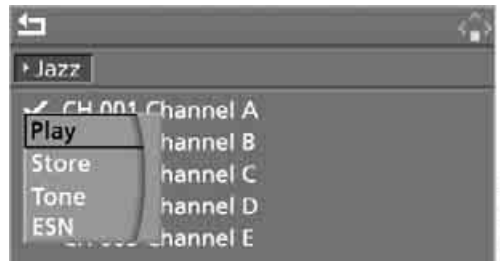

Additional information

The name of the channel and additional information on the current track are displayed, e.g. the name of the artist.

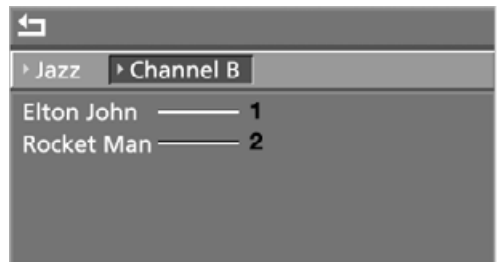

- 1 Artist
- 2 Track

Storing channel

1. Select desired channel.
2. Press the controller.
Other menu items are displayed.
3. Select "Store" and press the controller.

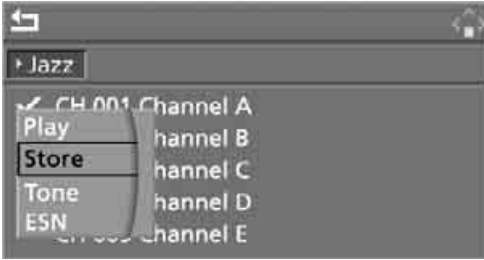

"Presets" is displayed.

4. Turn the controller to select a memory location and press the controller.

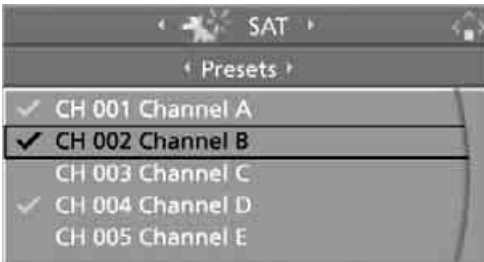

The channel is stored. The channels of the last selection criterion are displayed once again after a short time.

Changing channel with buttons on CD player

Press the  button for the corresponding direction.
The system switches to the next enabled channel.

Notes

If no signal can be received for more than four seconds, a message is displayed on the Control Display.



Reception may not be possible for certain reasons, e.g. environmental influences or topographical conditions. The satellite radio has no influence on this.

The signal may not be available in tunnels or underground garages, next to tall buildings, near trees, mountains or other sources of radio interference.

Reception is usually possible again as soon as the signal is available again. ◀

CD player and CD changer*

Listening to CDs



When equipped with two drives:
The upper drive is for audio CDs.

Compressed audio files

CDs with compressed audio files, i.e. MP3, can be played by the CD player and CD changer.

Starting CD player

Inserting CD

Insert the CD into the drive with the labeled side up.

The CD is automatically pulled in. Playback starts automatically if the sound output is on. For CDs with compressed audio files, it can take up to approx. 1 minute to read in the data depending on the directory structure.

Via iDrive

Starting playback when there is already a CD in the drive:

iDrive, for operating principle refer to page 16.

1. Press the **MENU** button.
This opens the start menu.
2. Move the controller backwards to open "Entertainment".

3. Change to upper field if necessary. Select "CD" and press the controller.



4. Change to the second field from the top if necessary. On vehicles with a CD changer, select "CD" and press the controller to start the CD player.



Playback starts automatically if the sound output is switched on.

With programmable memory/ direct selection buttons

You can store the function CD player on the programmable memory/direct selection buttons to start the CD player, refer to page 21.

Starting CD changer

Filling CD changer, refer to page 179.

Via iDrive

1. Press the **MENU** button.
This opens the start menu.
2. Move the controller backwards to open "Entertainment".

3. Change to upper field if necessary. Select "CD" and press the controller.
4. Change to the second field from the top if necessary. Select the desired CD and press the controller.



At the end of the last track, the next CD will be selected.

With programmable memory/direct selection buttons

You can store a CD compartment of the CD changer on the programmable memory/direct selection buttons to start the CD changer, refer to page 21.

Selecting a track

Buttons on CD player

Press the  button for the corresponding direction repeatedly until you reach the desired track.

The track is displayed on the Control Display. You can also change tracks using the buttons on the steering wheel, refer to page 11.

Via iDrive



Select a track by turning the controller.

Compressed audio files

1. Select the directory if necessary and press the controller.

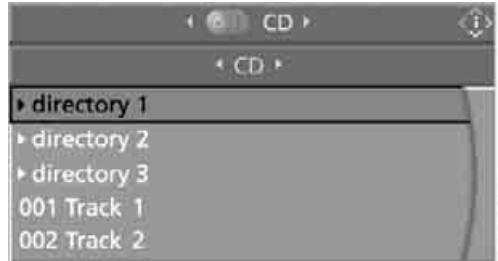

2. Select the track and press the controller.

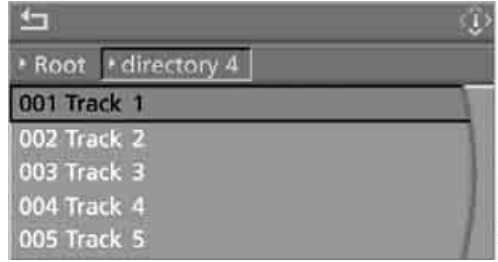

To change the directory:

Select the directory and press the controller.

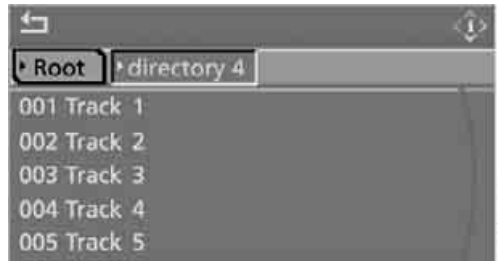

To exit from the menu:

 Select the arrow and press the controller.

For equipment with two drives, you can store a certain track on the programmable memory/direct selection buttons, refer to page 21.

Displaying information on track

With compressed audio files, you can display any information stored on the current track, e.g. the name of the artist.

1. Press the controller.
2. Select "Details" and press the controller.

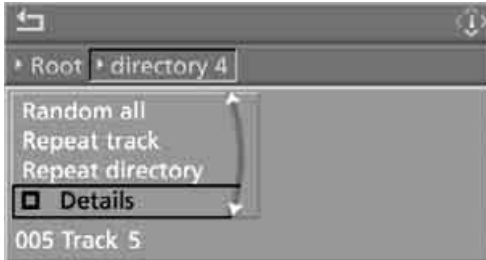

The information for the current track are displayed.

The setting is stored for the remote control currently in use.

Sampling tracks, scan

The system automatically plays a brief sample from each of the tracks on the current CD.

1. Select "Set" and press the controller.
Other menu items are displayed.



2. Select "Scan" and press the controller.

To end sampling:

1. Press the controller.
2. Select "Scan" and press the controller.

This cancels sampling of the tracks, and the player remains on the current track.

Compressed audio files

1. Select the current track and press the controller.
2. Select the desired menu item:
 - ▷ To sample all tracks of the current directory, select "Scan directory" and press the controller.
 - ▷ To sample all tracks of the CD, select "Scan all" and press the controller.



To end sampling:

1. Press the controller.
2. Select "Scan directory" or "Scan all" and press the controller.

This cancels sampling, and the player remains on the current track.

Repeating a track

1. Select "Set" and press the controller.
Other menu items are displayed.



2. Select "Repeat" and press the controller.



The current track on the CD is repeated.

To stop repeating:

1. Press the controller again.
2. Select "Repeat" and press the controller.

Compressed audio files

1. Select the current track and press the controller.
2. Select the desired menu item:
 - ▷ To repeat the selected track, select "Repeat track" and press the controller.
 - ▷ To repeat all tracks of the current directory, select "Repeat directory" and press the controller.

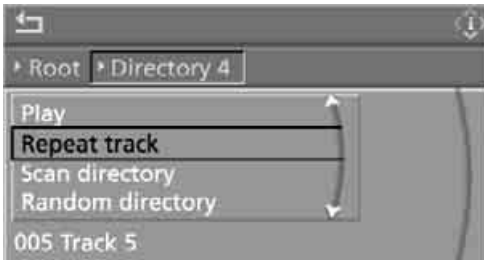

To stop repeating:

1. Press the controller.
2. Select "Repeat track" or "Repeat directory" and press the controller.

Random play sequence

In this mode, the tracks on the current CD are played once in a random sequence.

1. Select "Set" and press the controller. Other menu items are displayed.
2. Select "Random" and press the controller.

To stop random function:

1. Press the controller.
2. Select "Random" and press the controller.

Compressed audio files

1. Select the current track and press the controller.
2. Select the desired menu item:
 - ▷ To play all tracks of the current directory in random order, select "Random directory" and press the controller.
 - ▷ To play all tracks of the CD in random order, select "Random all" and press the controller.

To stop random function:

1. Press the controller.
2. Select "Random directory" or "Random all" and press the controller.

Fast forward/reverse

Buttons on CD player:

Press and hold the  button for the corresponding direction.

The tracks can be listened to with some distortion.

CD changer



The BMW CD changer for six CDs is installed in the glove compartment.

Controls and displays

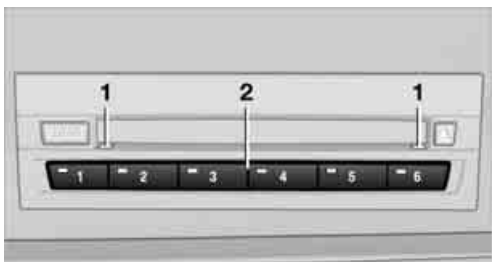

- 1 LEDs on the CD bay flash when the CD can be inserted.
- 2 Buttons for CD compartments LED lights up when CD compartment is filled.

Filling CD changer

1. Press the **LOAD** button.
The LED on the first empty compartment flashes.
2. Select another CD compartment if necessary:
Press the **1 ... 6** button.
3. When the LEDs **1** on the CD bay flash, insert an individual CD.
The CD is automatically pulled in and inserted into the selected CD compartment.

 Do not push in the CD until the LEDs **1** on the CD bay are flashing; otherwise, the CD or the CD changer may be damaged.

Do not continue to push on the CD; this may cause it to jam and prevent it from being able to eject again. ◀

4. To fill additional CD compartments:
Repeat steps 1 to 3.

Filling empty CD compartments

1. Hold down the **LOAD** button.
The LEDs on the empty CD compartments flash.
2. When the LEDs **1** on the CD bay flash, insert an individual CD.
The CD is automatically pulled in and inserted into the first available CD compartment.

 Do not push in the CD until the LEDs **1** on the CD bay are flashing; otherwise, the CD or the CD changer may be damaged.

Do not continue to push on the CD; this may cause it to jam and prevent it from being able to eject again. ◀

3. Wait until the CD has been pulled in.
4. To fill additional CD compartments:
Repeat steps 2 and 3.

Removing CDs from CD changer

1. Press the  button.
2. Press the **1 ... 6** button to select the CD compartment.
The CD is pushed partway out of the CD changer.
3. Remove the CD.

Removing all CDs from CD changer

1. Hold down the  button.
The CDs are pushed partway out of the CD changer in sequence.
2. Remove the CDs.

Notes

 BMW CD/DVD players and changers are officially designated Class 1 laser products. Do not operate if the cover is damaged, otherwise severe eye damage can result. Do not use self-recorded CDs/DVDs with labels applied as these can become detached during playback due to heat buildup and can cause irreparable damage to the device. Only use round CDs/DVDs with a standard diameter of 4.7 in/12 cm and do not play CDs/DVDs with an adapter, e.g. CD singles, as otherwise the CD/DVD or the adapter can jam and may no longer eject properly. Do not use a combined CD/DVD, e.g. DVD^{Plus}, otherwise the CD/DVD can jam and will no longer eject. ◀

General malfunctions

BMW CD/DVD changers and players have been optimized for performance in vehicles. In some instances they may be more sensitive to faulty CDs/DVDs than stationary devices would be. If a CD/DVD cannot be played, first check if it has been inserted correctly.

Humidity

High levels of humidity can lead to condensation on the CD/DVD or the laser's scan lens and temporarily prevent playback.

Malfunctions with individual CDs/DVDs

If malfunctions occur only with particular CDs/DVDs, this can be due to one of the following causes.

Filling the CD/DVD changer or removing CDs/DVDs

If all of the LEDs on the CD/DVD changer flash rapidly, then a malfunction is occurring.

To rectify the malfunction:

1. Press the  button.
The CD/DVD last inserted is ejected.
2. Remove the CD/DVD.

When the LEDs stop flashing rapidly, the CD/DVD changer is once more operational.

Self-recorded CDs/DVDs

Possible reasons for malfunctions with self-recorded CDs/DVDs are, e.g., inconsistent data-creation or recording processes, or poor quality or high age of the CD/DVD blank.

Only label CDs/DVDs on the upper side with a pen intended for this purpose.

Avoiding damage

Avoid fingerprints, dust, scratches and moisture.

Store CDs/DVDs in a sleeve.

Do not subject CDs/DVDs to temperatures over 122 °F /50 °C, high levels of humidity or direct sunlight.

CDs/DVDs with copy protection

CDs/DVDs are often provided with a copy protection feature by the manufacturer. This can mean that some CDs/DVDs cannot be played or can only be played to a limited extent.

Care

If necessary, clean the reflective scanning side of the CDs/DVDs with a commercially available cleaning cloth by wiping in straight lines from the center outward. For additional information on the care of CDs/DVDs, refer to the Caring for your vehicle brochure.

DVD changer*

Installation position



The BMW DVD changer for six DVDs is installed in the glove compartment.

Controls and displays



- 1 LEDs on the DVD bay
Flash when the DVD can be inserted.
- 2 Buttons for DVD compartments
The LED lights up when DVD compartment is filled.

Filling the DVD changer

1. Press the **LOAD** button.
The LED on the first empty compartment flashes.
2. Select another DVD compartment if necessary:
Press the **- 1 ... - 6** button.
3. When the LEDs **1** on the DVD bay flash, insert an individual DVD.
The DVD is automatically pulled in and inserted into the selected DVD compartment.

 Do not push in the DVD until the LEDs **1** on the DVD bay are flashing; otherwise, the DVD or the DVD changer may be damaged.

Do not continue to push on the DVD; this may cause it to jam and prevent it from being able to eject again. ◀

4. To fill additional DVD compartments:
Repeat steps 1 to 3.

Filling empty DVD compartments

1. Hold down the **LOAD** button.
The LEDs on the empty DVD compartments flash.
2. When the LEDs **1** on the DVD bay flash, insert an individual DVD.
The DVD is automatically pulled in and inserted into the first available DVD compartment.

 Do not continue to push on the DVDs; this may cause them to jam and prevent them from being able to eject again. ◀

3. Wait until the DVD has been pulled in and the LEDs **1** on the DVD bay are flashing again.

 Do not push in the DVD until the LEDs **1** on the DVD bay are flashing; otherwise, the DVD or the DVD changer may be damaged. ◀

4. To fill additional DVD compartments:
Repeat steps 2 and 3.

Removing DVDs from the DVD changer

1. Press the  button.
2. Press the **- 1 ... - 6** button in order to select the DVD compartment.
The DVD is pushed partway out of the DVD changer.
3. Remove the DVD.



 If the DVD is not removed, it is pulled back in again after about 10 seconds. ◀

Removing all DVDs from the DVD changer

1. Hold down the  button.
The DVDs are pushed partway out of the DVD changer in sequence.
2. Remove the DVDs individually.

Malfunctions

If all of the LEDs on the DVD changer flash rapidly, then a malfunction is occurring. In this case, proceed as follows.

1. Press the  button or  button.
The DVD last inserted is ejected.
2. Remove the DVD.

The DVD changer tests the DVD compartments and the rapid flashing of the LEDs stops. The DVD changer is once more operational.

DVD country codes

Your DVD player only plays DVDs with the coding of your home region, e.g. Europe = 2. The country codes supported by your DVD are contained in the information on your DVD. It is not possible to change this coding. An overview of the six coding zones:

Code	Region
1	USA, Canada
2	Japan, Europe, Middle East, South Africa
3	Southeast Asia
4	Australia, Central and South America, New Zealand
5	Northwest Asia, North Africa
6	China

 DVDs with the code 0 can be played back on all units. ◀

Playing DVDs

Depending on the equipment in your vehicle, you have the option of playing back both the audio track and video track of DVDs or only their audio track.

- ▷ Vehicles with two drives: audio and video playback
- ▷ Vehicles with a single drive: audio playback, refer to page 186

Audio and video playback

For your own safety, the picture only appears in the Control Display at speeds of up to about 2 mph/3 km/h. For certain national-market versions, the picture does not appear in the Control Display unless the vehicle is stopped and the transmission is in Park.

1. Press the **MENU** button.
This opens the start menu.
2. Move the controller backwards to open "Entertainment".
3. Change to upper field if necessary. Select "DVD" and press the controller.
4. Switch into the second field if necessary, select the desired DVD and press the controller.



It can take a little time for the DVD contents to be scanned in. Then the DVD is played and the DVD-specific menu is displayed.

DVD control

Using the DVD control, you can select the title and chapter, open the DVD-specific menu and operate functions such as language, fast forward and reverse, or freeze frame.

A DVD can briefly deactivate functions of the DVD control, under certain circumstances even while the entire DVD is being played. It is not possible to operate the DVD control under these circumstances. In this case, try to make the selection using the DVD-specific menu.

During playback:

1. Press the controller.
2. Select "DVD control bar" if needed and press the controller.

The DVD control is displayed.



The DVD control disappears again after a short time if you have not selected a function.

	Function
	Exit DVD control
"SET"	Settings for playing DVD
	Start playback
	Stop playback
	Activating freeze frame
	Skip chapter
	Fast forward/reverse
"Menu"	Open DVD-specific menu

Fast forward/reverse

Forward/reverse with DVD control

1. Press the controller during playback to hide the DVD control.
2. Select the symbol and press the controller.
3. Press the controller repeatedly to increase the speed of the fast forward/reverse. The DVD playback will be distorted.

To cancel fast forward/reverse:

Select the symbol and press the controller. The DVD will start play at the point selected.

Forward/reverse using the controller

1. Turn the controller during playback. Fast forward/reverse is interrupted.
2. Turn the controller further. The speed is increased.
3. Release the controller. Fast forward/reverse is interrupted. The current DVD will start play at the point selected.

Skip chapter

You can change to the next or previous chapter during playback.

1. Press the controller during playback to hide the DVD control.
2. Select the symbol and press repeatedly until you reach the desired chapter.

Or:

Press the button on the left or right repeatedly until you reach the desired chapter.

Making settings for DVD

With some DVDs, it is only possible to select language, subtitles, camera angle, or title by using the DVD-specific menu. Refer to the information on your DVD for possible selections. ◀

Tone control

In DVDs with multichannel or surround sound, for optimum playback, select an audio track with multichannel sound and set the tone settings to Surround, refer to Selecting language on page 184 and Professional HiFi System* on page 165.

Adjusting brightness and contrast

1. Press the controller during playback.
2. Select "SET" and press the controller.
3. Select "Video settings" and press the controller.

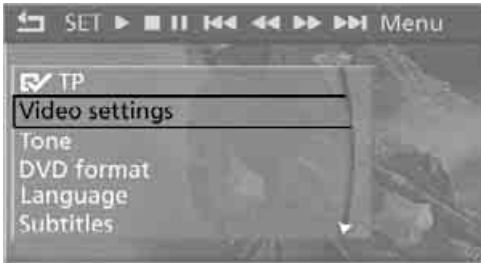

4. Select "Brightness" or "Contrast" and press the controller.



5. Turn the controller until the desired setting is selected.

Resetting to defaults:

Select "Reset" and press the controller.



DVD format

1. Press the controller during playback.
2. Select "SET" and press the controller.
3. Select "DVD format" and press the controller.

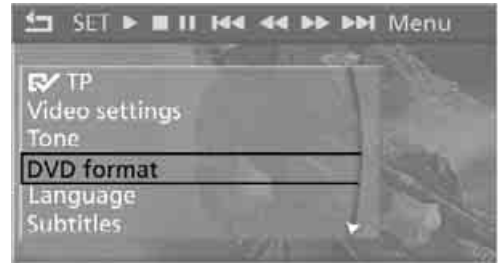

- ▷ "Standard"
- ▷ "Zoom": full-screen playback.

Selecting language

1. Press the controller during playback.
2. Select "SET" and press the controller.
3. Select "Language" and press the controller.
4. Select language or audio track and press the controller.

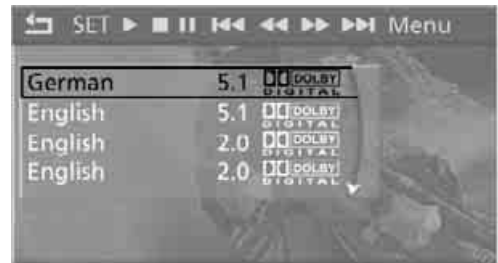

The languages and audio tracks are generally accompanied by an indication of how many channels are included. 5.1 means multichannel.

Selecting subtitles

1. Press the controller during playback.
2. Select "SET" and press the controller.
3. Select "Subtitles" and press the controller.
4. Select the language of the subtitles and confirm by pressing the controller.



Selecting title

1. Press the controller during playback.
2. Select "SET" and press the controller.
3. Select "Title" and press the controller.
4. Select the desired title.

Changing viewing angle

Notes or symbols that appear during the playback of a film generally indicate the availability of different camera angles. These are usually only briefly available.

1. Press the controller during playback.
2. Select "SET" and press the controller.
3. Select "Angle of view" and press the controller.



Opening DVD-specific menu

Additional functions may be available on DVDs. For example, the viewer can select from several possible plots or display information on the film.

1. Press the controller during playback.
2. Select "Menu" and press the controller.



3. Make your selection in the DVD-specific menu. To do so, move the controller in the corresponding direction in order to select the menu items and then press the controller.
4. Select "Confirm selection" and press the controller.

 You can also select language, subtitles, camera angle, or title in the DVD-specific menu.

Refer to the information on your DVD for possible selections. ◀

Closing the settings menu

- ▶ Select "Return" and press the controller.

Audio playback

In vehicles equipped with a single drive, you have the option of playing back the audio track of a DVD, even when no video playback is possible in the vehicle.

1. **MENU** button.
This opens the start menu.
2. Move the controller backwards to open "Entertainment".
3. Change to upper field if necessary. Select "DVD" and press the controller.
4. Switch into the second field if necessary, select the desired DVD and press the controller.



Displaying DVD audio contents

DVDs are usually divided into titles that are divided into chapters. The playback begins with the title that contains the most chapters. For example, this has the advantage that the introduction of a DVD is not played first.

All of the chapters, numbered all the way through, are show, i.e. the numbering is different than on the DVD. The numbering of the DVD is displayed in the status line.

Example:



Chapter 06 of the selection corresponds to chapter 4 in title 1 of the DVD.

	Display in the status line	Display in the chapter selection
Title 1	Chapter 1	01
	Chapter 2	02
Title 2	Chapter 1	03
	Chapter 2	04
	Chapter 3	05
	Chapter 4	06
Title 3	Chapter 1	07
	Chapter 2	08

Since the first title is not played automatically, the display in the chapter selection can begin with a higher number than 01.

 The behavior during playback of the DVD can differ, depending on the DVD. It may not be possible to play some DVDs or the playback may stop before the end. In this case, the system usually skips to the next DVD in the DVD changer. ◀

Selecting chapter

Select the chapter by turning the controller.



If playback does not automatically continue after the end of a title, then use the controller to select the next chapter.

A maximum of 99 chapters of a DVD can be played back.

Tone control

In DVDs with multichannel or surround sound, for optimum playback, select an audio track with multichannel sound, refer to [Selecting audio language](#), and set the tone settings to Surround, refer to [Professional HiFi System*](#) on page [165](#).

Selecting audio language

If there are different languages on a DVD, you can select the language.

1. Select "Set" and press the controller. Other menu items are displayed.
2. Select "Language / Audio format" and press the controller.



The different languages of the DVD are displayed.

3. Select the desired language and press the controller.



The languages and audio tracks are generally accompanied by an indication of how many channels are included. 5.1 means multichannel.

Notes

The DVD changer can play back the following formats:

- ▷ DVD video
- ▷ Video CD
- ▷ CD-DA
- ▷ CD-DTS
- ▷ Compressed audio files

MACROVISION

This product includes copyright-protected technology that is based on a series of registered US patents and the intellectual property of the Macrovision Corporation and other manufacturers. Use of this copyrighted material must be approved by Macrovision. Unless otherwise agreed upon with Macrovision, it is only permissible for correspondingly protected media to be produced for private use. The copying of this technology is strictly forbidden.

Dolby

Manufactured under license from Dolby Laboratories.

"Dolby", "Pro Logic", "MLP Lossless" and the double-D symbol are registered trademarks of Dolby Laboratories.

DTS

"DTS" and "DTS Digital Surround" are registered trademarks of DTS, Inc.

AUX-In connection

You can connect an external audio device, e.g. an MP3 player, and play the sound via the vehicle loudspeakers. The sound can be adjusted via iDrive.

Connecting

Open the lid of the center armrest.

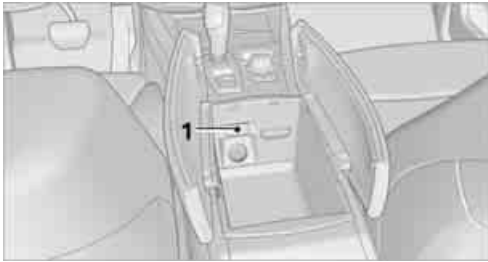

- 1 Connection for audio playback:
TRS connector 1/8 in/3.5 mm

To play audio tracks through the car's loudspeaker system, connect the headphone or line-out port of the device with the AUX-In connection.

Starting audio playback

The audio device must be switched on.

Via iDrive

iDrive, for operating principle refer to page 16.

1. Press the **MENU** button.
This opens the start menu.
2. Move the controller backwards to open "Entertainment".
3. Change to upper field if necessary. Turn the controller until "AUX" is selected and press the controller.



4. Select "AUX IN" and press the controller.
5. Adjust volume and sound if necessary.

With programmable memory/ direct selection buttons

You can save the function "AUX" on the programmable memory/direct selection buttons to start audio playback, refer to page 21.

USB audio interface*

You can connect audio devices to the USB audio interface, e.g. an iPod or a USB device (MP3 player, USB memory stick). You can then operate these with iDrive.

The common audio files, e.g. MP3, WMA, WAV (PCM) and AAC, as well as playback lists in the M3U format can be played back.

Due to the large number of audio devices available on the market, operation via the vehicle cannot be ensured for every audio device. Ask your BMW Sports Activity Vehicle Center which audio devices are suitable.

Connecting

Open the lid of the center armrest.

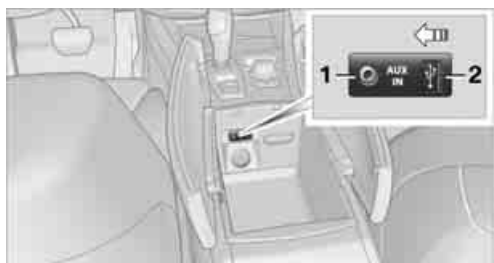

- 1 Connection for audio playback: TRS connector 1/8 in/3.5 mm
- 2 USB interface

iPod

To connect the iPod, use the BMW cable adapter for Apple iPods. For more information, please contact a BMW Sports Activity Vehicle Center or consult our website: www.bmw.com

For audio playback via the vehicle loudspeakers, connect the iPod to the connections **1** and **2**.

The menu structure of the iPod is supported by the USB audio interface.

USB device

 Use a flexible adapter cable for connection to protect the USB interface and your USB device against mechanical damage. ◀

For audio playback via the vehicle loudspeakers, connect the USB device to the connection **2**.

After connecting for the first time, the information of all tracks (e.g. artist, music genres) and the playback lists of the USB device are transferred to the vehicle. This process can take some time. The time required is dependent on the USB device and on the number of tracks.

During the transfer you can select the tracks via the directories and file names.

Following the transfer you can call up the tracks via the information and playback lists.

The information of up to four USB devices or for a total of approx. 20,000 tracks can be stored in the vehicle.

If a fifth USB device is connected or if more than 20,000 tracks are to be stored, then the information about existing tracks is deleted if necessary.

 Music tracks with integrated Digital Rights Management (DRM) cannot be played. ◀

Starting audio playback

Via iDrive

If the audio device has a device name, this will be displayed if possible.

1. Press the **MENU** button.
This opens the start menu.
2. Move the controller backwards to open "Entertainment".
3. Change to upper field if necessary. Turn the controller until "AUX" is selected and press the controller.



4. Select "USB" or the name of the audio device and press the controller.



The playback starts with the first track.

With programmable memory/ direct selection buttons

You can save the function "USB" on the programmable memory/direct selection buttons to start audio playback, refer to page 21.

Selecting a track

You can call up the tracks via the playback lists and information. With USB devices you can also call up the tracks via the file directory. The titles can be displayed if they are stored in the Latin alphabet.

1. Make your selection, e.g. "Playlists" or "Artists", and press the controller.



2. Select the track and press the controller.

Displaying information on track

You can display any information stored on the current track, e.g. the name of the artist.

1. Press the controller during playback.
2. Select "Details" and press the controller.

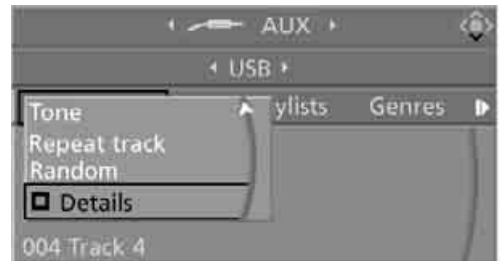

The information for the current track are displayed.

Repeating a track

1. Select the current track and press the controller.
2. Select "Repeat track" and press the controller.

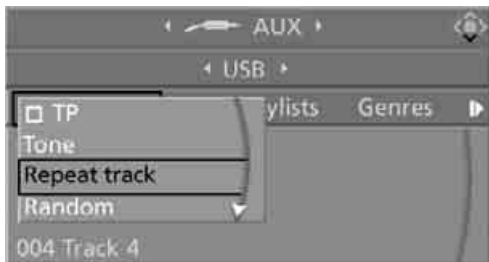

To stop repeating:

1. Press the controller.
2. Select "Repeat track" and press the controller.

Random play sequence

You can play back the tracks of the selected list in random order, e.g. all tracks of an artist.

1. Select the current track and press the controller.
2. Select "Random" and press the controller.

To end random playback:

1. Press the controller.
2. Select "Random" and press the controller.

Fast forward/reverse

Buttons on the steering wheel or on the CD player:

Press and hold the  button for the corresponding direction.

Notes

 Do not subject the audio device to extreme environmental conditions, e.g. extremely high temperatures, refer to the operating instructions of the audio device. Otherwise the audio device may be damaged, impairing driving safety while driving. ◀

Depending on the configuration of the audio files, e.g. bit rates greater than 256 Kbit/s, proper playback cannot always be ensured.

Information on connection

- ▷ The USB audio interface supplies the connected audio device with power, provided the audio device supports this function. Therefore, do not connect the USB audio device to a socket in the vehicle during operation.
- ▷ Do not use force when plugging the connector into the USB interface.
- ▷ Do not connect any devices, e.g. fans or lamps, to the USB audio interface.
- ▷ Do not connect USB hard disks.
- ▷ Do not use the audio interface to recharge external devices.

DVD system in rear*

With the DVD system in the rear you can play CDs and DVDs with audio, video and image data. External audio and video devices can also be connected and played via the DVD system in the rear.

Tone output is possible both via headphones and via the vehicle loudspeakers.

You can operate the DVD system in the rear with the buttons on the CD/DVD player or with the remote control.

 Some functions can only be operated with the remote control. ◀

Enabling DVD system

Enable the DVD system with iDrive. For operating principle refer to page 16.

1. Press the **MENU** button.
This opens the start menu.
2. Press the controller to open the **i** menu.
3. Select "Settings" and press the controller.
4. Select "Unlock rear menu" and press the controller.
5. Select "Rear enabled" and press the controller.

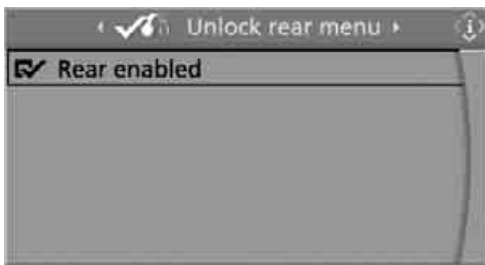

 The DVD system is enabled.

Controls

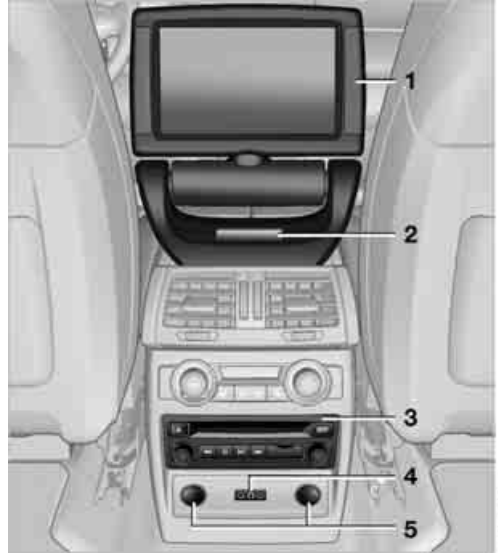

- 1 Display screen
- 2 Infrared interface for headphones
- 3 CD/DVD player
- 4 Headphone connection:
Jack plug 1/8 in/3.5 mm
- 5 12 V sockets, refer to page 122

Folding in display screen

When using the ski bag or when transporting bulky pieces of luggage, the display screen should be folded in, as otherwise it may be damaged.

 Do not open the covers of the center armrest or rest your arm on the display screen with the display screen folded in, as otherwise the display screen may be damaged. ◀



1. Turn display screen, arrow **1**.
The display screen switches off.
2. Fold in display screen, arrow **2**.
The display screen is folded out in the reverse order.

CD/DVD player

Controls

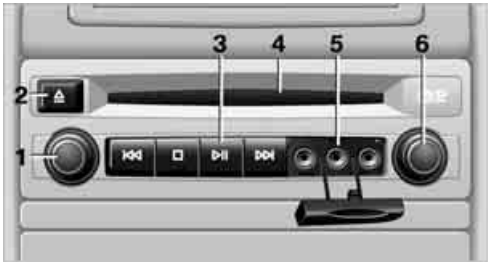

- 1 Press: switching DVD system on/off
Turn: volume for headphones on left
- 2 Eject CD, DVD
- 3 Start of track, reverse
 Stop
 Playback, pause, hold screen
 Next track, fast forward
- 4 CD/DVD bay
- 5 Connection for external device:
Cinch sockets with protective cap
- 6 Press: switching DVD system on/off
Turn: volume for headphones on right

Connecting headphones

You can connect headphones with a jack plug 1/8 in/3.5 mm or operate them using the infrared interface.

Ask your BMW Sports Activity Vehicle Center which infrared headphones are supported by the infrared interface.

When using infrared headphones, the infrared connection between the headphones and the infrared interface may not be interrupted. This means that no obstacle may be located between them and the cover of the infrared interface may not be covered or scratched. Unfavorable lighting conditions, such as glaring ambient light, can result in poor reception. ◀

Remote control

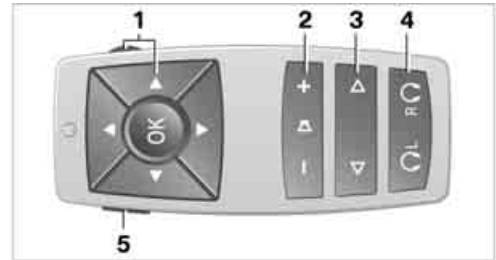

- 1 Menu navigation
- 2 Volume for headphones with jack plug
- 3 Change track or chapter with CD or DVD playback, fast forward/reverse
- 4 Switch over headphones right/left
- 5 Open start menu for DVD system

Menu navigation

You can navigate through the menus with the knurled wheel **1** and the buttons **1**. For operating principle also refer to iDrive, page **16**.

- ▶ Turn the knurled wheel **1**:
Selecting a menu item.
- ▶ Press buttons **1**:
Changing between fields.

- ▶ Press the **OK** button:
Activating menu item.

Changing batteries



1. Press the detent and remove the cover.
2. Change the batteries. The type and installation position are marked on the bottom of the battery compartment.
3. Close the cover.

 Return used batteries to a recycling collection point or to your BMW Sports Activity Vehicle Center. ◀

Sound output via loudspeakers

In addition to the headphones, you can also play the sound via the vehicle loudspeakers.

As soon as a plug is inserted in the AUX-In connection in the center console, the sound output of the DVD system via the vehicle loudspeakers is interrupted.

iDrive, for operating principle refer to page 16.

1. Press the **MENU** button.
This opens the start menu.
2. Move the controller backwards to open "Entertainment".

3. Select "AUX / Rear" and press the controller.

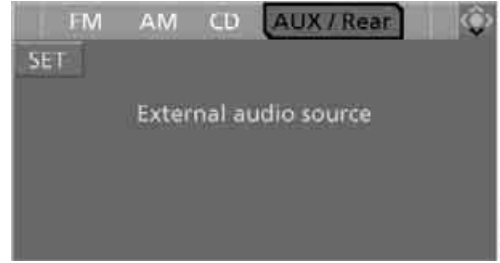

Switching DVD system on/off

Press the button on the CD/DVD player.

The DVD system switches on automatically when a CD or DVD is inserted.

Playing CD/DVD

The menu item with which the contents of the CD/DVD can be called up is dependent on the data on a CD or DVD:

- ▶ Video data via "DVD"
- ▶ Audio data via "CD"
- ▶ Images via "Photo"



Playing videos from CD/DVD

Country codes of DVDs

Your DVD player only plays DVDs with the coding of your home region, e.g. Europe = 2. The country codes supported by your DVD are contained in the information on your DVD.

An overview of the coding zones:

Code	Region
1	USA, Canada
2	Japan, Europe, Middle East, South Africa
3	Southeast Asia
4	Australia, Central and South America, New Zealand
5	Northwest Asia, North Africa
6	China

Starting playback

1. Push the CD/DVD into the drive with the labeled side facing upward. The CD/DVD is automatically pulled in.
 - ▷ Playback usually begins automatically after a few seconds.
 - ▷ If playback does not begin automatically: Select "DVD". Press the  button.
2. If the DVD control or the DVD-specific menu is displayed for a DVD, select the desired option for menu guidance with the remote control buttons.

Or:

Press the  button on the CD/DVD player.

You can control the playback with the buttons on the CD/DVD player or the DVD control.

 Video CDs, VCD, and Super Video CDs, SVCD, can be played like DVDs if they do not have a DVD menu of their own. ◀

Ejecting CD/DVD

Press the  button on the CD/DVD player. The DVD emerges slightly from the drive.



DVD control







With the DVD control, you can select the track and chapter, open the DVD-specific menu and operate functions such as Language, Fast forward and Reverse or Freeze frame.

A DVD can briefly deactivate functions of the DVD control, under certain circumstances while the entire DVD is being played. It is not possible to operate the DVD control under these circumstances. In this case, try to make the selection using the DVD-specific menu.

1. Press the  button on the remote control during playback.



2. Press the   buttons on the remote control or turn the knurled wheel to select the desired function.
3. Press the  button.

	Function
	Exit DVD control
"SET"	Settings for playing DVD
	Start playback
	Stop playback
	Activate and deactivate freeze frame
	Skip chapter
	Fast forward/reverse
"Menu"	Open DVD-specific menu





The DVD control disappears again after a short time if you have not selected a function.

Or:

Press the  button on the remote control to exit the DVD control.



Fast forward/reverse

Forward/reverse with DVD control

1. Press the  button on the remote control during playback.
2. Select the  symbol.
3. Press the  button.
4. Press the  button several times to increase the fast forward/reverse speed.

The DVD playback will be distorted.

To cancel fast forward/reverse:

1. Select the  symbol.
2. Press the  button.

Or:

Press the  button on the CD/DVD player.

The DVD will start play at the point selected.

Forward/reverse with remote control

Press and hold the  button until you reach the desired point.



Or:

1. During playback, turn the knurled wheel. Fast forward/reverse is interrupted.
2. Continue to turn the knurled wheel. The speed is increased.
3. Press the  button on the CD/DVD player. Fast forward/reverse is interrupted.

The DVD will start play at the point selected.

Skipping chapter

You can change to the next or previous chapter during playback.

1. Press the  button on the remote control during playback.
2. Select the  symbol.
3. Press the  button repeatedly, continuing until you reach the desired chapter.



Or:

Press the  button on the left or right on the remote control repeatedly until you reach the desired chapter.



Freeze frame

1. Press the  button on the remote control during playback.



2. Select the  symbol.
3. Press the  button.

To continue playback:

1. Select the  or  symbol.
2. Press the  button.



As an alternative you can also stop and continue playback with the  button on the CD/DVD player.

Making settings for DVD

1. Press the  button during playback.



2. Make the settings with the remote control:
 - ▷ "Video settings":
 - ▷ "Brightness", "Color" and "Contrast" of screen display
 - ▷ Additional settings can be made after changing to the top field.
 - "Language": system language of DVD system in rear.
 - "Display": background brightness of screen.

- ▷ "Tone":
 - ▷ "Treble / Bass" and "Balance": Separately adjustable for the left and right-hand headphones and the infrared headphones.
 - ▷ "Reset": The settings are reset to the default value.
- ▷ "DVD format":
 - ▷ "Standard"
 - ▷ "Zoom": full-screen playback.
- ▷ "Language": Language or sound track of DVD playback. The language advances one setting each time the menu item is selected.
- ▷ "Subtitles": Language of subtitles
"00 n/a": no subtitles.
- ▷ "Title": Selection of a single track of the DVD.
- ▷ "Angle of view": Camera angle
Notes or symbols that appear during the playback of a film generally point out different camera angles. These are usually only briefly available.
- ▷ "Menu": Call up the DVD-specific menu.
- ▷ "Return": Exit menu or:
Press the   buttons on the remote control.



Many DVDs offer dialogs and subtitles in various languages or scene descriptions for the hearing impaired. These functions are stored on the DVD.

 With some DVDs, it is only possible to select language, subtitles, camera angle, or track by using the DVD-specific menu. Refer to the information on your DVD for possible selections.

Entries marked in gray in the menus cannot be selected. ◀

Opening DVD-specific menu

Additional functions may be available on DVDs. For example, it is possible to select from several possible plots or display information on the film.

1. Press the  button on the remote control during playback.
2. Select "Menu".
3. Press the .

 On some DVDs, selecting "Menu" and "Title" gives you the option of choosing from additional menus. ◀

To make a selection:

1. Use the buttons on the remote control to select the desired function in the DVD-specific menu.
2. Press the .

 You can also select language, subtitles, camera angle, or track in the DVD-specific menu.

Observe the information on your DVD. ◀

Compressed video files

Playback

1. Select the directory if necessary.



2. Press the .

3. Select a track.

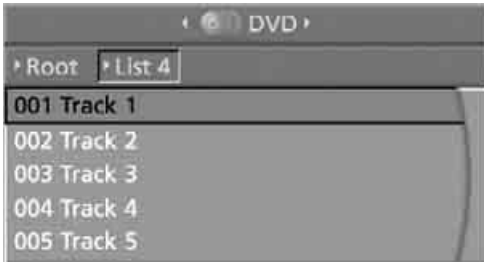

4. Press the **OK** button.
5. Select "Play".



6. Press the **OK** button.
- To change the directory:
1. Select the directory.



2. Press the **OK** button.

Playback functions

1. Select a track.
2. Press the **OK** button.
3. Select a menu item:
 - ▷ "Play": Start playback.
 - ▷ "Pause": Stop and continue playback.

- ▷ "Repeat track": Repeat the selected track.
- ▷ "Repeat directory": Repeat the tracks in the current directory.

4. Press the **OK** button.

Playing audio tracks from CD/DVD

Start playback

Push the CD/DVD into the drive with the labeled side facing upward.

The CD/DVD is automatically pulled in.

- ▷ Playback begins automatically after a few seconds.
- ▷ If playback does not begin automatically: Select "CD". Press the **OK** button.

For CDs/DVDs with compressed audio files, refer to page 199, it may take several minutes to read the data depending on the directory structure.

To start playback when there is already a CD/DVD in the drive:

1. Open the start menu with the remote control.
2. Select "CD".

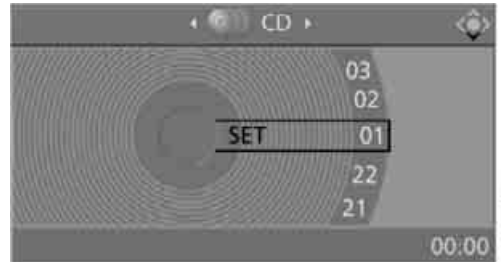



As an alternative you can also control the playback with the buttons on the CD/DVD player.

To eject CD/DVD:

Press the **EJECT** button on the CD/DVD player.



Selecting a track

Buttons on CD/DVD player

Press the   button for the corresponding direction repeatedly until you reach the desired track.

Playback begins at the start of the track.

Via the remote control

Press the   button for the corresponding direction repeatedly or turn the knurled wheel until you reach the desired track.

Playback begins at the start of the track.

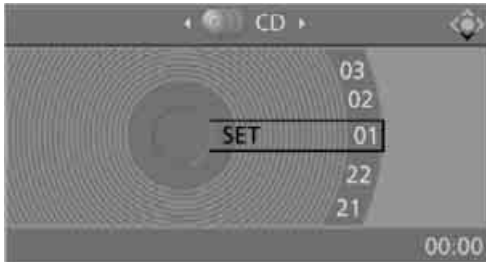

Settings and playback functions for audio CDs/DVDs

1. Select "SET".
2. Press the  button.

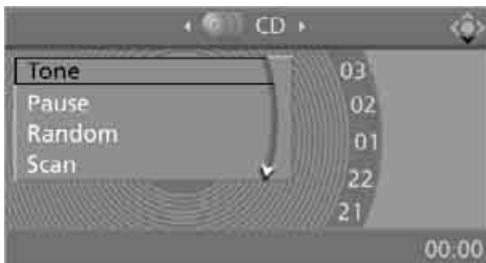

3. Make the settings with the remote control:

- ▷ "Tone":
 - ▷ "Treble / Bass" and "Balance": Separately adjustable for the left and right-hand headphones and the infrared headphones.
 - ▷ "Reset": The settings are reset to the default value.

- ▷ "Pause": Stop and continue playback.
- ▷ "Random": In this mode, the tracks on the CD/DVD are played once in a random sequence.
- ▷ "Scan": Automatically briefly sample all tracks of the CD/DVD consecutively.
- ▷ "Repeat": Repeat the current track. Select again to end.

Fast forward/reverse

Buttons on the CD/DVD player:

Press and hold the   button for the corresponding direction.

Remote control:

Press and hold the   button until you reach the desired point.

Compressed audio files

With some CDs/DVDs playback may automatically start with the first track.

Playback

1. Select the directory if necessary.



2. Press the  button.

3. Select a track.



4. Press the **OK** button.

To change the directory:

1. Select the directory.



2. Press the **OK** button.

Settings and playback functions for compressed audio files

1. Select a track.

2. Press the **OK** button.

3. Make the settings with the remote control:



▷ "Tone":

- ▷ "Treble / Bass" and "Balance": Separately adjustable for the left and right-hand headphones and the infrared headphones.

▷ "Reset":

The settings are reset to the default value.

▷ "Pause":

Stop or continue playback.

▷ "Scan directory":

Briefly sample the tracks in the current directory.

▷ "Scan all":

Briefly sample all tracks.

▷ "Random directory":

Play the tracks in the current directory in a random sequence.

▷ "Random all":

Play all tracks in a random sequence.

▷ "Repeat track":

Repeat the selected track.

▷ "Repeat directory":

Repeat the tracks in the current directory.

▷ "Details":

Display any stored information on the current track.

Displaying images from CD/DVD

1. Push the CD/DVD into the drive with the labeled side facing upward.

The CD/DVD is automatically pulled in.

2. Open the start menu with the remote control.

3. Select "Photo".

4. Press the **OK** button.

Displaying overview

1. Select the subdirectory if necessary.
2. Select "Overview".

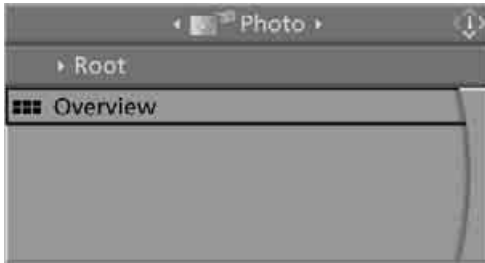

3. Press the **OK** button.
It may take some time until the overview is completely displayed.
4. Scroll through the overview with the menu guidance of the remote control.

 If a symbol is shown instead of an image, the image cannot be shown in the overview. ◀

Displaying images

1. Select an image with the buttons of the remote control.
2. Press the **OK** button.







3. Select type of display:
 - ▶ Scroll with the menu guidance buttons of the remote control.
 - ▶ Show slide show:
Turn the knurled wheel to set the display duration and the sequence of the display.
Stop slide show:
Select "Stop".

Adjusting

1. Press the **OK** button.





2. Select a menu item:

	Function
	Return to the photo menu
"SET"	"Display": adjusting the brightness of the screen. "Language": the language of the system can be set after changing to the top field
	Start slide show.
	Show first/last image
	Rotate image by 90°
"Overview"	Change to image overview

3. Press the **OK** button.

Ending display

1. Press the  button.
2. Select the  symbol.
3. Press the **OK** button.

Ejecting CD/DVD

Press the  button on the CD/DVD player.

Information on CD/DVD player

Safety notes

 The BMW CD/DVD player is a Class 1 laser product. Do not operate if the cover is damaged or open, otherwise severe eye damage can result. ◀

Suitable media

 Do not use self-recorded CDs/DVDs with labels applied as these can become detached during playback due to heat buildup and can cause irreparable damage to the device.

Only use round CDs/DVDs with a standard diameter of 4.7 in/12 cm.

Never play CDs/DVDs with adapters, e.g. single-CDs, as otherwise the CDs or the adapter can jam and may not be ejected.

Never use combined CD/DVD, e.g. DVD^{Plus} or hybrid disks, as otherwise the CD/DVD can jam and may not be ejected. ◀

The CD/DVD player can play the following media:

- ▷ Video DVD
- ▷ CD-DA (Audio CD)
- ▷ CDs/DVDs with compressed image files
- ▷ CDs/DVDs with compressed audio files
- ▷ CDs/DVDs with compressed video files

DVD Audio and SACD are not supported by the DVD player. However, many audio DVDs available in stores also contain a video track in the DVD Video format in addition to the audio track. These DVDs can be played back by the DVD player. Please refer to the information on your DVD to determine whether your audio DVD contains an additional video track.

Depending on the authoring used, it is possible that not all functions are available during playback.

Dual-sided DVDs available from retail suppliers are coated on both sides and bear no markings. This means both sides are information carriers.

To play the information on the other side, turn over the DVD.

Supported formats

Depending on the compression method used, not all files of the specified formats can be opened.

Images

JPEG/JPG

With very large image files, it may take a longer time until the images are shown.

Compressed audio files

- ▷ MP3
- ▷ WMA
- ▷ OGG
- ▷ AAC

Compressed video files

- ▷ VCD
- ▷ SVCD
- ▷ MPEG1
- ▷ MPEG2
- ▷ MPEG4

Digital Rights Management DRM

It may not be possible to play CDs/DVDs with integrated Digital Rights Management.

General malfunctions

The BMW CD/DVD player is optimized for operation in the vehicle. It may react more sensitively to defective CDs/DVDs than devices intended for stationary use.

If a CD/DVD cannot be played, first check whether it has been inserted correctly.

 Make sure that no foreign bodies or liquids enter the CD-/DVD bay, as otherwise the CD/DVD player will be damaged. ◀

Humidity

High levels of humidity can lead to condensation on the CD/DVD or the laser's scan lens and temporarily prevent playback.

Malfunctions with individual CDs/DVDs

If malfunctions occur only with particular CDs/DVDs, this can be due to one of the following causes.

Copied or self-recorded CDs/DVDs

Possible reasons for malfunctions with copied or self-recorded CDs/DVDs are, e.g., inconsistent data-creation or recording processes, or poor quality or high age of the CD/DVD blank. Only label CDs/DVDs on the side with the label using a pen intended for this purpose.

Damaged CDs/DVDs

Avoid fingerprints, dust, scratches and moisture.

Store CDs/DVDs in a sleeve.

Do not subject CDs/DVDs to temperatures over 122 °F/50 °C, high levels of humidity or direct sunlight.

CDs/DVDs with copy protection

CDs/DVDs are often provided with a copy protection feature by the manufacturer. As a result, some CDs/DVDs cannot be played, can only be played to a limited degree, or cause the system to switch off. In this case, wait a short while and then switch the system back on again. Then remove the CD/DVD from the drive.

CDs/DVDs with compressed audio files

If the language set for the CD/DVD player does not match the language of the music track, the music tracks may be displayed incorrectly.

Care instructions

Do not use cleaning CDs with a brush.

External device

Connecting

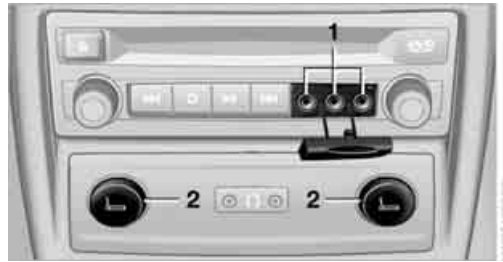

- 1 Connections for audio/video cables:
Watch the colors of the sockets when connecting.
Yellow socket: video
White socket: audio left
Red socket: audio right
- 2 Power supply for external device: sockets with removable cap, also refer to page 121

Playback

1. Switch on the external device and start the playback.
2. Open the start menu with the remote control.
3. Select "AUX".
4. Press the **OK** button.



For devices without a video signal, e.g. MP3 players, "No video signal" is shown. The sound is nevertheless played.

Settings for external devices

1. Press the **OK** button during playback.

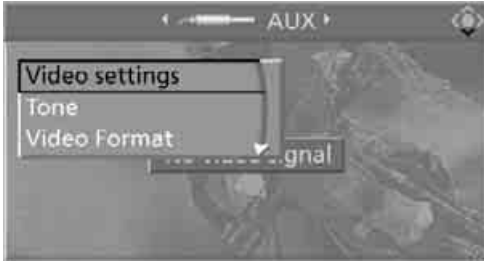

2. Make the settings with the remote control:

- ▷ "Video settings":
 - ▷ "Brightness", "Color" and "Contrast" of video playback.
 - ▷ "NTSC color":
The color can be adjusted on an external device with the NTSC standard.
 - ▷ "Standard":
The DVD system in the rear can be adapted to external devices with various TV standards. When doing so, also refer to the operating manual of the external device.
 - ▷ "Reset":
The settings are reset to the default value.
- ▷ "Tone":
 - ▷ "Treble / Bass" and "Balance" can be adjusted for the left and right-hand headphones and the infrared headphones.
 - ▷ "Reset":
Your settings are reset.
 - ▷ Additional settings can be made after changing to the top field.
 - "Audio": adjust the volume of the external device to the volume of the CD/DVD player.
 - "Language": system language of the DVD system in the rear.
 - "Display": background brightness of screen.
- ▷ "Video Format":
 - ▷ "Standard"
 - ▷ "Zoom": full-screen playback



Communications

This chapter summarizes how to operate your mobile phone using iDrive or voice control and how to use BMW Assist or TeleService.

Telephoning*

The concept

Your BMW is equipped with a full mobile phone preparation package. After pairing a suitable mobile phone in the vehicle once, you can operate the mobile phone via iDrive, with the buttons on the steering wheel and by voice.

A mobile phone that has been paired once is automatically detected again with the engine running or the ignition switched on as soon as it is in the vehicle interior. The pairing data of up to four mobile phones can be stored simultaneously. If several mobile phones are detected simultaneously, the respective last mobile phone paired can be operated via the vehicle.

Using a phone in your vehicle

Using snap-in adapter*

The so-called snap-in adapter, a mobile phone cradle, enables the battery to be charged and the mobile phone to be connected to the external antenna of your vehicle. This ensures improved network reception and a consistent voice reproduction quality. Ask your BMW Sports Activity Vehicle Center which mobile phones snap-in adapters are offered for.

For your safety

A car phone makes life more convenient in many ways, and can even save lives in an emergency. While you should consult your mobile phone's separate operating instructions for a detailed description of safety precautions and information, we request that you direct your particular attention to the following:



Only make entries when the traffic situation allows you to do so. Do not hold the mobile phone in your hand while you are driving; use the hands-free system instead. If you do not observe this precaution, your being distracted can endanger vehicle occupants and other road users. ◀

Suitable mobile phones

Ask your BMW Sports Activity Vehicle Center which mobile phones with a Bluetooth interface are supported by the mobile phone preparation package or which mobile phones snap-in adapters are available for. These mobile phones support the functions described in this Owner's Manual with a certain software version. Malfunctions can occur with other mobile phones.

Care instructions

You can find what you need to know about caring for your mobile phone in the Caring for your vehicle brochure and in the separate mobile phone operating instructions.

Operating options

You can operate the mobile phone* using:

- ▷ Buttons on steering wheel, refer to page 11
- ▷ iDrive, refer to page 214
- ▷ Voice commands, refer to page 219
- ▷ Programmable memory/direct selection buttons, refer to page 21

Avoid operating a mobile phone detected by the vehicle with the keypad of the mobile phone, otherwise malfunctions can occur.

Placing phone calls with BMW Assist system*: BMW Assist calls

You can use the BMW Assist system via the hands-free unit for BMW Assist calls.

When the status information "Communication" or "BMW Assist" is displayed in "BMW Service", only BMW Assist calls are possible.

It may not be possible to establish a telephone connection using the mobile phone while a connection is being established to BMW Assist or while a call to BMW Assist is already in

progress. If this happens, you must log off the mobile phone from the vehicle if you wish to place a call with the mobile phone.

Commissioning

Logging on mobile phone on vehicle

The following prerequisites must be met:

- ▶ Suitable mobile phone: the mobile phone is supported by the full mobile phone preparation package. Information on this subject is also provided on the Internet at: www.bmw.com
- ▶ The mobile phone is ready to operate.
- ▶ The Bluetooth link on the vehicle, refer to page 213, and on the mobile phone is active.
- ▶ Depending on the mobile phone, presettings on the mobile phone are necessary, e.g. via the following menu items:
 - ▶ Bluetooth activated
 - ▶ Connection not with confirmation
 - ▶ Reconnect
- ▶ Depending on the mobile phone model, the setting energy saving mode can, for example, result in vehicle failing to detect the paired mobile phone.
- ▶ For pairing, specify any desired number as the Bluetooth passkey, e.g. 1. This Bluetooth passkey is no longer required following successful logon.
- ▶ The ignition is switched on.

 Only pair the mobile phone with the vehicle stopped, otherwise the passengers and other road users can be endangered due to a lack of attentiveness on the part of the driver. ◀

Switching on ignition

1. Insert the remote control as far as possible into the ignition lock.
2. Switch on the ignition by pressing the Start/ Stop button without depressing the brake pedal.

Preparation via iDrive

iDrive, for operating principle refer to page 16.

3. Press the **MENU** button to open the start menu.



4. Press the controller to open the **i** menu.
5. Select "Settings" and press the controller.



6. Select "Bluetooth" and press the controller.



7. Change into the second field from the top, select "Phone" and press the controller.



8. Select "Pair new phone" and press the controller.



9. Select "Start pairing" and press the controller.



The Bluetooth name of the vehicle is displayed.

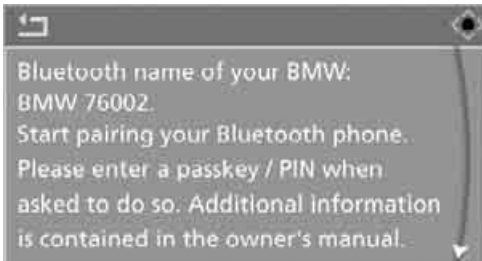

Preparation with mobile phone

10. Additional operations must be carried out on the mobile phone and differ depending on the model, refer to the operating instructions of your mobile phone, e.g. find, connect or pair under Bluetooth device. The Bluetooth name of the vehicle is also shown on the mobile phone display.
11. Select the Bluetooth name of the vehicle on the mobile phone display.

Pairing

Depending on your mobile phone, you will first be requested consecutively via the display of your mobile phone or iDrive to enter the Bluetooth passkey you specified.

12. Enter the Bluetooth passkey.

Depending on the mobile phone, approx. 30 seconds are available for entering the Bluetooth passkey on the mobile phone and on the Control Display.

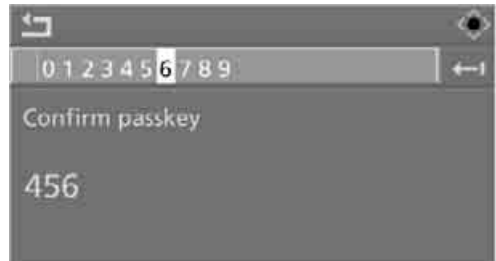

13. Change into the third field from the top, select "Confirm passkey" and press the controller.

14. Wait a few seconds until the "Communication" menu appears.

The next time you use the mobile phone in the vehicle interior, it will be detected within a maximum of 2 minutes with the engine running or the ignition switched on.

- ▶ With some mobile phone models it may be necessary to make certain settings for a permanent Bluetooth link, e.g. via the menu item Authorization or Secure connection, refer to the operating instructions of your mobile phone. ◀

As soon as a mobile phone is detected by the vehicle, the phone book entries stored on the SIM card or on your mobile phone are transmitted to your vehicle. This transmission is dependent on your mobile phone, refer to the operating instructions of your mobile phone if necessary, and can take several minutes.

If not all phone book entries are displayed:

- ▶ Transfer all phone book entries from the SIM card to the mobile phone if necessary.
- ▶ It may not be possible to display phone book entries with special characters.

Up to four mobile phones can be paired consecutively. When you pair a fifth mobile phone, the pairing data of the mobile phone for which the pairing data were stored first in the vehicle will be deleted.

Check if pairing is unsuccessful

- ▶ Is the mobile phone supported by the mobile phone preparation package? Information on this subject is also provided on the Internet at: www.bmw.com.
- ▶ Do the Bluetooth passkeys on the mobile phone and the vehicle match? The same Bluetooth passkey must be entered both on the mobile phone display and via iDrive.
- ▶ Have you required longer than 30 seconds to enter the Bluetooth passkey?
- ▶ Only a limited number of devices can be connected to the mobile phone. Delete the connection to other devices if necessary.
- ▶ The mobile phone no longer reacts? Switch the mobile phone off and then on again or disconnect the power supply.

To repeat pairing:

1. Select "Restart pairing" and press the controller.
2. Repeat steps 9 to 14.

If pairing was repeatedly unsuccessful, contact BMW Customer Relations.

To call BMW Customer Relations:
Select "Help" and press the controller.

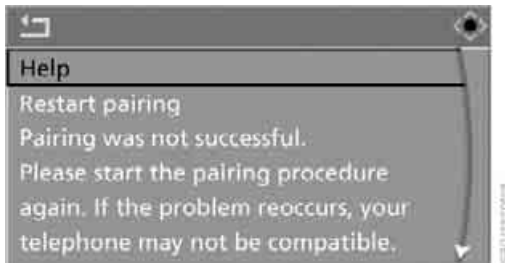

The phone number of BMW Customer Relations and information required for pairing is shown on the display. With mobile phones already paired, you can select the phone number of BMW Customer Relations to establish the connection.



List of paired mobile phones

The mobile phones for which the vehicle has stored the pairing data can be displayed. If several paired mobile phones are detected by the vehicle simultaneously, you can operate the mobile phone highest up in the list via the vehicle.

You can change the order of the mobile phones in the list. As long as a mobile phone is selected in this list, the mobile phones cannot be operated via the vehicle.

iDrive, for operating principle refer to page 16.

1. Press the **MENU** button to open the start menu.
2. Press the controller to open the **i** menu.
3. Select "Settings" and press the controller.
4. Select "Bluetooth" and press the controller.
5. Change into the second field from the top, select "Phone" and press the controller.
6. Select the desired mobile phone.

With two drives:

- ▷ Move the controller to the rear to change to the bottom field.
- ▷ Select the desired mobile phone and press the controller.

With a single drive:

- ▷ Select the desired mobile phone and press the controller.



7. Select "Move device up" and press the controller.



The selected mobile phone is moved upward by one position.

Unpairing mobile phone from vehicle

If you no longer want to operate a mobile phone via the vehicle, you can delete the pairing data of the mobile phone.

iDrive, for operating principle refer to page 16.

1. Switch off the mobile phone.
2. Press the **MENU** button to open the start menu.
3. Press the controller to open the **i** menu.
4. Select "Settings" and press the controller.
5. Select "Bluetooth" and press the controller. "Bluetooth" is selected.
6. Change into the second field from the top, select "Phone" and press the controller.
7. Select the desired mobile phone.

With two drives:

- ▷ Move the controller to the rear to change to the bottom field.
- ▷ Select the desired mobile phone and press the controller.

With a single drive:

- ▷ Select the desired mobile phone and press the controller.



8. Select "Delete device" and press the controller.

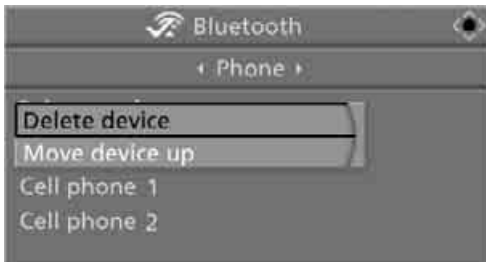

The unpaired mobile phone is deleted from the list.

The phone book entries and the lists of stored phone numbers are also deleted.

Activating/deactivating Bluetooth link

 Bluetooth technology is not approved in all countries. Observe the applicable local regulations. Temporarily deactivate the Bluetooth link between the vehicle and the mobile phone if necessary.

If the Bluetooth link is deactivated, you cannot operate your mobile phone via the vehicle and other devices with a Bluetooth interface can be used via the mobile phone, e.g. a laptop computer. ◀

To temporarily deactivate the Bluetooth link between your vehicle and your mobile phone:

1. Press the **MENU** button to open the start menu.
2. Press the controller to open the **i** menu.
3. Select "Settings" and press the controller.

4. Select "Bluetooth" and press the controller.



5. Change into the second field from the top, select "Settings" and press the controller.



6. Select "Bluetooth communication active" and press the controller to activate or deactivate the link.

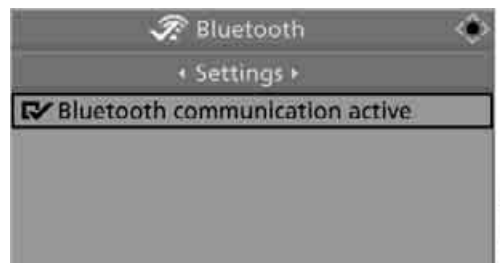

- The Bluetooth link is activated.
- The Bluetooth link is deactivated.

Adjusting volume

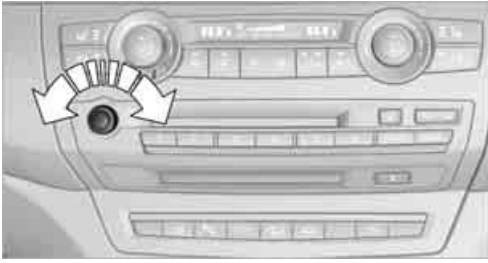

Turn the knob during a call to select the desired volume.

This volume for the hands-free system is maintained, even if the other audio sources are set to minimum volume.

You can also adjust the volume with buttons on the steering wheel, refer to page 10.

The setting is stored for the remote control currently in use.

Operation via iDrive

You can operate the following functions via iDrive:

- ▷ Accepting/refusing a call
- ▷ Dialing phone numbers
- ▷ Dialing phone numbers from the phone book
- ▷ Dialing stored phone numbers, e.g. from the list of accepted calls.
- ▷ Ending a call

When the ignition and radio readiness are switched off, e.g. after removing the remote control from the ignition lock, you can continue an ongoing call via the hands-free system for no more than 25 minutes.

Speech quality

If the person you are talking to cannot understand you well, this may be due to excessively loud background noises. The full mobile phone preparation package can compensate for these noises to a certain degree. To optimize the

speech quality during a call, we recommend that you:

- ▷ Reduce background noises, e.g. by closing the windows, reducing the air volume of the automatic climate control or pointing the opened front air vents downward
- ▷ Reduce volume of hands-free system

Requirements

- ▷ The pairing data of the mobile phone are stored in the vehicle and the mobile phone is ready to operate.
- ▷ The engine is running or the ignition is switched on.
- ▷ The mobile phone is detected by the vehicle.

Opening Communication

You operate many of the functions described in the following via the "Communication" menu.

iDrive, for operating principle refer to page 16.

1. Press the **MENU** button to open the start menu.



2. Move the controller forward to open "Communication".

Receiving calls

If you have the phone number of the caller stored in the phone book and the phone number has been transmitted, the name of the entry is displayed.

Accepting a call

Press the  button on the steering wheel.

Alternative:

"Accept" is selected.

Press the controller.

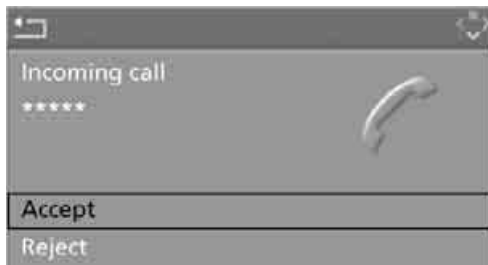

Rejecting a call

Select "Reject" and press the controller.

The caller is diverted to your mailbox if it has been activated.

Calling

Dialing phone numbers

1. Select "Phone" and press the controller.



2. Select "Dial" and press the controller.

3. Enter the desired phone number by dialing the individual digits and pressing the controller.

Always enter the complete phone number consisting of national dialing code, area code, and phone number.

The letters correspond to the digits on the keypad of the mobile phone.

To delete the last digit:

Move the controller toward the right to select the arrow  and press the controller.

4. Select "Dial number" and press the controller.

Alternative: press the  button on the steering wheel.



For your phone number to be displayed to the person you are calling, the display of phone numbers must be enabled by your service provider.

With programmable memory/ direct selection buttons

You can store phone numbers on the programmable memory/direct selection buttons to call them directly, refer to page 21.

Ending a call

Press the  button on the steering wheel.

Alternative:

1. Select the phone number and press the controller.



- "End call" is selected.
Press the controller.



Dialing a phone number from phone book or a phone number stored in a list

Phone numbers you have called, incoming calls and the entries of the phone book are stored in lists when the mobile phone is connected to the vehicle via Bluetooth. If the caller is entered in the phone book, the name of the entry is displayed instead of the phone number.

You can select the desired subscriber from the list and establish the connection.

Five lists are available:

- ▷ "A - Z"
The entries of the mobile-phone phone book, consisting of the name and phone number, are sorted alphabetically.
- ▷ "Top 8"
The eight numbers called most frequently from the phone book "A - Z" are automatically stored in the Top 8 list.
- ▷ "Redial"
The last eight phone numbers you have dialed are automatically stored. The last number dialed is at the top of the list.
- ▷ "Missed calls"
The phone numbers of the last eight calls which were not accepted are stored. This requires the telephone number of the caller to have been sent.
- ▷ "Received calls"
The phone numbers of the last eight accepted calls are stored. This requires the telephone number of the caller to have been sent.

Dialing phone numbers from phone book

The list "A - Z" is available for your phone book entries. The phone book entries appear on the Control Display.

- Select "Phone" and press the controller.



- Select "A - Z" and press the controller.
- To limit the number of displayed entries, select the first letter of the desired entry and press the controller.
- Select the desired entry and press the controller.

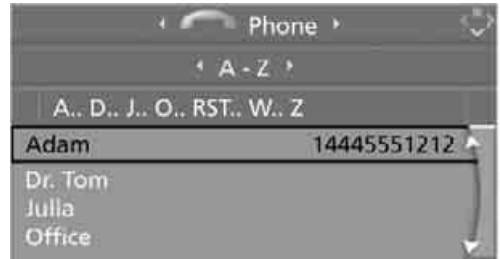

- Select "Call" and press the controller.
The system dials the number.

If different phone numbers are stored in the mobile phone under one name, e.g. office and home, the name is shown once for each phone number.

You can change a phone number stored in the phone book, e.g. to call a specific extension:

- Select "Phone" and press the controller.
- Select "A - Z" and press the controller.
- Select the desired entry and press the controller.
- Select "Add digits" and press the controller.

5. Change the phone number.
6. Select "Dial number" and press the controller.

Dialing a phone number stored in a list

To select an entry and establish a connection:

1. Select "Phone" and press the controller.
2. Select list and press the controller:
 - ▷ "Top 8"
 - ▷ "Redial"
 - ▷ "Missed calls"
 - ▷ "Received calls"



3. Select the desired entry and press the controller.



4. Select "Call" and press the controller. The system dials the number.

Deleting individual entries

1. Select the desired entry from the list and press the controller.
2. Select "Delete" and press the controller. The entry is deleted.



Deleting entire list

1. Select an entry from the list and press the controller.
2. Select "Delete all numbers" and press the controller.



3. Select "Yes" and press the controller. The list is deleted.

BMW Contact*

If you are not enabled for BMW Assist, you can have several service phone numbers displayed:

- ▷ Roadside Assistance* of the BMW Group when you require breakdown assistance
- ▷ BMW Sports Activity Vehicle Center, e.g. when you want to make an appointment for service
- ▷ BMW Customer Relations* for information on all aspects of your vehicle

If BMW Assist is enabled, refer to page 223.

You can select the displayed service phone number if your mobile phone is logged on in the vehicle:

iDrive, for operating principle refer to page 16.

1. Press the **MENU** button.
This opens the start menu.
2. Move the controller forward to select "Communication".
3. Select "BMW Contact" and press the controller.



4. Select "BMW Contact Numbers" and press the controller.



5. Select one of the following menu items and press the controller:
 - ▷ "Roadside Assistance"
 - ▷ "Customer Relations"
 - ▷ "Service Request"
6. Select "Call" and press the controller.
Contact is established.

Transferring phone number via tone dialing method

The tone dialing method is required for access to network services or for controlling devices, e.g. remote checking of an answering machine.

This function is available when a connection has been established.

1. Establish connection.



2. With a single drive:
Press the controller.
Select "Keypad" and press the controller.
With two drives:
Move the controller backwards until the bottom field is selected.
3. Select the desired character and press the controller.
Each character is sent immediately and confirmed by a tone depending on the mobile phone model.



Changing between mobile phone and hands-free system

From mobile phone to hands-free system*

You can continue calls begun outside the Bluetooth range of the vehicle via the handsfree system when the engine is running or the ignition is switched on. Depending on your mobile phone, the system automatically switches over to the handsfree mode.

For mobile phones that do not automatically switch over to the handsfree mode:

- ▶ Depending on the mobile phone model used, the conversation can be continued via the hands-free system if necessary. Act according to what is shown on the mobile phone display, refer to the operating instructions of your mobile phone.
- ▶ Press the  button above the storage compartment. Switching over may take several seconds.

From handsfree system to mobile phone

When you telephone via the handsfree system, you can also continue the call via the mobile phone if necessary, depending on the mobile phone model. Act according to what is shown on the mobile phone display, refer to the operating instructions of your mobile phone.

As an alternative, you can deactivate the Bluetooth link.

Depending on your mobile phone model, poor reception of the wireless communications network can result in the system changing from the hands-free system to the mobile phone.

Operation by voice*



The concept

You can operate your mobile phone without having to remove your hands from the steering wheel. When making your entries, you will be

supported by announcements or questions in many cases.

The same prerequisites as for operation via iDrive apply, refer to page 214.

Symbols in Owner's Manual

-  ›...‹ Say the specified commands word for word.
-  ›...‹ Indicates responses of the system.

Voice commands

Activating system

1. Briefly press the  button on the steering wheel.
An acoustic signal indicates that you can say commands.
2. Say the command.

Ending/canceling operation by voice

Press the  button on the steering wheel or

-  ›Cancel‹.

In dialogs where text is spoken, not a command, e.g. a name, canceling is only possible using the button on the steering wheel.

Having possible commands read aloud

The system understands default commands that must be spoken word for word. You can have the possible commands spoken by the system at any point:

-  ›Help‹

Using alternative commands

There are often a number of commands to run a function, e.g.:

-  ›Dial name‹ or ›Name‹.

The system recognizes digits from zero to nine. You can say each digit individually or group them into a sequence to accelerate the input.

Example: dialing phone numbers

To start the dialog:

Press the  button on the steering wheel.

Command	The voice control answers
›Dial number‹ e.g. ›123 456 7890‹	››Please say the number‹‹ Depending on equipment: ››123 456 7890. Continue?‹‹ or ››123 456 7890. And next?‹‹
›Dial‹	››Dialing number‹‹

Adjusting volume of instructions

You can adjust the volume for the instructions from the system:

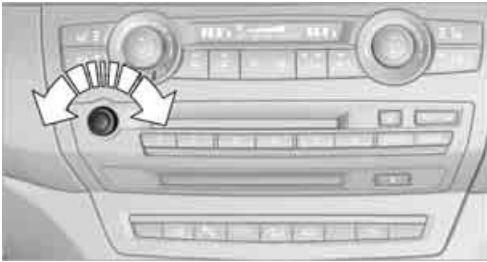

Turn the knob during instructions.

This volume for the instructions is maintained, even if the other audio sources are set to minimum volume.

The setting is stored for the remote control currently in use.

Calling

Dialing phone numbers

1. ›Dial number‹.
2. Say the phone number.
For telephone calls abroad, say ›Plus‹ and then the country code.
3. ›Dial‹.

The connection to the desired subscriber is established.

Correcting phone number

After the last spoken sequence of digits has been repeated by the system, you can delete this sequence of digits.

-  ›Correct number‹.
The digits are deleted.

The command ›Correct number‹ can be repeated as often as you like.

Deleting phone number

-  ›Delete‹.

All digits entered up to this point are deleted.

Voice phone book

Operating by voice command requires a personal voice phone book.

- ▶ With separate drives for audio CDs and navigation DVDs, the entries are automatically applied from your mobile phone's memory.
- ▶ With a single drive, the entries must be entered by voice and are independent of your mobile phone's memory. In this case, it is not possible to use voice command either to call phone numbers stored in the mobile phone or to store new numbers. Up to 50 entries can be input. An entry always consists of a name and phone number.

Creating and editing voice phone book*

Store entry:

An entry always consists of a name and phone number.

1. ›Save name‹.
The dialog for storing a name is opened.
2. Speak the name.
The spoken length of the names in the phone book must not exceed approx. 2 seconds.
3. Say the phone number when prompted.
4. To store the phone number:
›Save‹.

Delete entry:

You can delete any entry from the voice phone book.

1. ›Delete name‹.
The dialog for deleting an entry is opened.
2. Say the name when prompted.
3. Confirm the prompt with ›Yes‹.

Delete all entries:

›Delete phone book‹ deletes all entries in the phone book.

1. ›Delete phone book‹.
The dialog for deleting phone book is opened.
2. Confirm the prompt with ›Yes‹.
3. Confirm the repeated prompt with ›Yes‹.

Have entries read aloud and select:

You can have all the entries of your voice phone book read aloud in the order of input and select a certain entry to establish a connection:

1. ›Read phone book‹.
The dialog for reading phone book is opened.
2. ›Dial number‹ when the desired entry is read aloud.

Selecting an entry

The connection to the phone number of the selected entry is established.

1. ›Dial name‹.
The dialog for selecting an entry is opened.
2. Say the name when prompted.
3. Confirm the prompt with ›Yes‹.

Redialing

The ›Redial‹ command opens "Redial".

Notes

Important for voice commands

For voice commands, keep the following in mind:

- ▷ Issue the commands smoothly and at normal volume, avoiding excessive emphases and pauses.
- ▷ Keep the doors, windows and glass sunroof closed to prevent interference from ambient noise.
- ▷ Avoid making other noise in the vehicle while speaking.

Mounting/removing snap-in adapter

1. Press the area **1** around the button and remove the cover*.

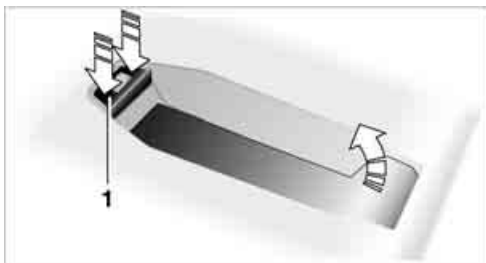

2. Insert the snap-in adapter at the front and press down until it engages.



To remove the snap-in adapter:
Press the area 1 around the button.

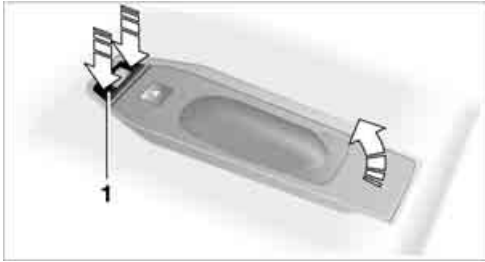

Inserting mobile phone

1. Remove the protective cap from the mobile phone's antenna connector if necessary, so that the mobile phone can engage in the snap-in adapter.
2. Push the mobile phone with the buttons facing upward toward the electrical connections and press down until it engages.

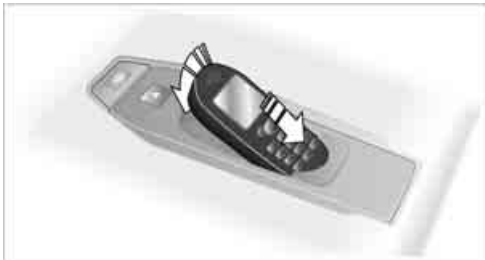

The mobile phone battery is charged from the radio readiness position.

 To protect the vehicle's batteries, avoid using the phone when the ignition is switched off. ◀

Removing mobile phone

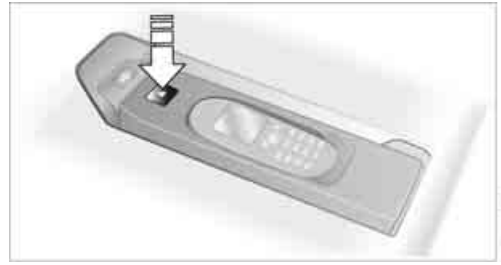

Press the button.

BMW Assist provides you with various services. For example, the position data of your vehicle can be transferred to the BMW Assist Response Center if an emergency request* has been initiated.

Many BMW Assist services depend on the individually agreed contract.

After your contract has expired, the BMW Assist system will be deactivated by the BMW Assist Response Center without you having to visit a BMW Sports Activity Vehicle Center. After the BMW Assist system has been deactivated, no BMW Assist service will be available. The BMW Assist system can be reactivated by a BMW Sports Activity Vehicle Center after signing a new contract.

Requirements

If the following requirements are met, you can use BMW Assist:

- ▶ The installed BMW Assist system is logged in on a wireless communications network. This network must be capable of transmitting the services.
- ▶ To transmit position data, the vehicle must be able to determine the current position.
- ▶ To activate and update BMW Assist, a GPS signal must be available.
- ▶ You have subscribed to BMW Assist with your BMW Sports Activity Vehicle Center or with the BMW Assist Response Center. Enabling must have been completed.
- ▶ BMW Assist is activated, refer to page 228.

Offered services

The following services are available via BMW Assist:

- ▶ **Emergency requests, refer to page 255:**
When you press the SOS button, a connection is established to the BMW Assist Response Center. The BMW Assist Response Center contacts you and takes further steps to help you.
- ▶ **Automatic collision notification:**
Under certain conditions, a connection is established to the BMW Assist Response Center after a serious accident. If possible, the BMW Assist Response Center contacts you and takes further steps to help you.
- ▶ **Enhanced roadside assistance:**
You can call BMW Roadside Assistance* should you require help in the event of a breakdown. If possible, the vehicle and position data are transmitted in the process.
- ▶ **BMW Customer Relations:**
For information on all aspects of your vehicle, you can be connected to BMW Customer Relations.
- ▶ **TeleService:**
The data on the service status of your vehicle or on required inspections are transmitted to your BMW Sports Activity Vehicle Center either automatically prior to the due date or when you request a BMW service appointment.
- ▶ **Remote door unlock:**
Inform the BMW Assist Response Center, e.g. if your remote control is not available and you want to have the vehicle unlocked.
- ▶ **Stolen vehicle recovery:**
After your vehicle has been reported to the police as stolen, the BMW Assist Response Center can locate its position.

In addition, you can be provided with other services, e.g. the concierge service or information on route planning, traffic conditions, and the

weather. With Critical Calling, you can make a limited number of calls via the BMW Assist Response Center, e.g. if you do not have your mobile phone with you.

Press the SOS button to contact the BMW Assist Response Center, see below.

You also have access to the BMW Assist concierge service via the Internet.

Characteristics of the offered services

The following special aspects apply to the services:

- ▷ The services offered are country-specific.
- ▷ Voice contact is established or data are transferred, depending on the equipment and the country. In some countries, it is possible to do both.
- ▷ The data transferred can, for example, be the vehicle data, your current position or the data of the CBS Condition Based Service.

Using services

Contact to the BMW Assist Response Center

You can contact the BMW Assist Response Center via the SOS button.

1. Briefly press protective cover to open. Depending on the vehicle's equipment, the arrangement of the switches and indicator lamps may differ somewhat.



2. Press the button for at least 2 seconds. The BMW Assist Response Center is contacted.

Roadside assistance

iDrive, for operating principle refer to page 16.

1. Press the **MENU** button. This opens the start menu.



2. Move the controller forward to select "Communication".
3. Change to upper field if necessary. Turn the controller until "BMW Assist" is selected and press the controller.

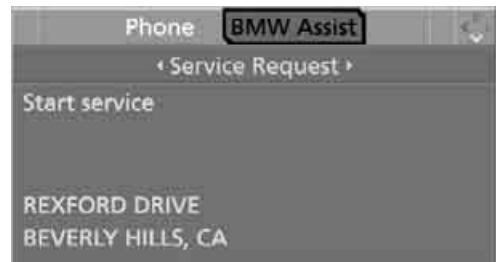

4. Select "Roadside Assistance" and press the controller.

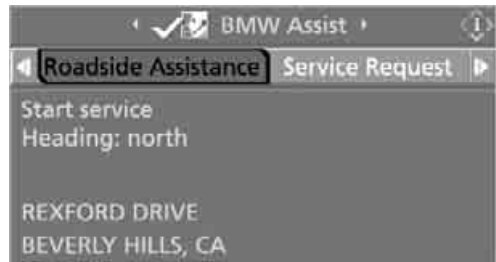

If the current position can be determined, the current vehicle location is displayed.

5. Select "Start service" and press the controller.

The BMW Assist Response Center will connect you to the BMW Roadside Assistance.

TeleService

Automatic service notification*

The data on the service status of your vehicle or on required inspections are transmitted automatically directly to your BMW Sports Activity Vehicle Center prior to the due date. You can check when the BMW Sports Activity Vehicle Center was notified.

1. Press the **MENU** button.
This opens the start menu.
2. Press the controller to open the **i** menu.
3. Select "Info sources" and press the controller.



4. Select "Service Info" and press the controller.
5. Change to upper field if necessary. Turn the controller until "Service requirements" is selected and press the controller.

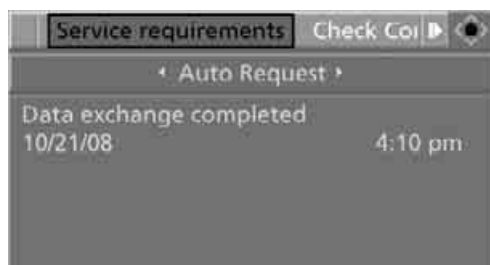

6. Select "Auto Request" and press the controller.

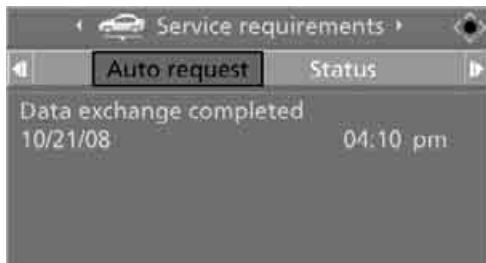

Manual service notification

You can transmit data regarding your vehicle's service status to your BMW Sports Activity Vehicle Center when you wish to arrange a service appointment.

1. Press the **MENU** button.
This opens the start menu.
2. Move the controller forward to select "Communication".
3. Change to upper field if necessary. Turn the controller until "BMW Assist" is selected and press the controller.

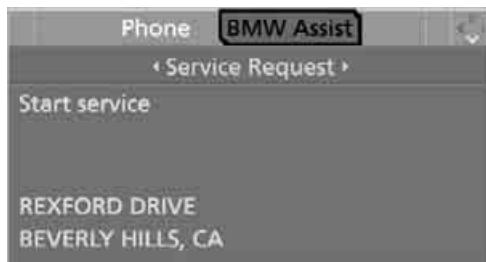

4. Select "Service Request".

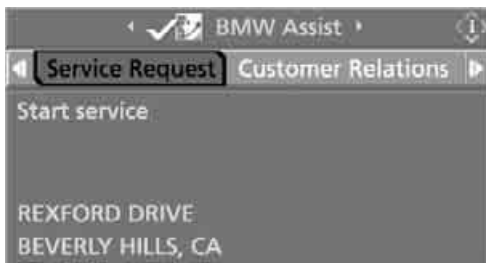

5. Press the controller.

6. Select "Start service" and press the controller.

The data relevant for service are transmitted. Your BMW Sports Activity Vehicle Center will contact you to set up an appointment for service.

Contacting BMW Customer Relations

For information on all aspects of your vehicle, you can contact BMW Customer Relations.

1. Press the **MENU** button.
This opens the start menu.
2. Move the controller forward to select "Communication".
3. Change to upper field if necessary. Turn the controller until "BMW Assist" is selected and press the controller.

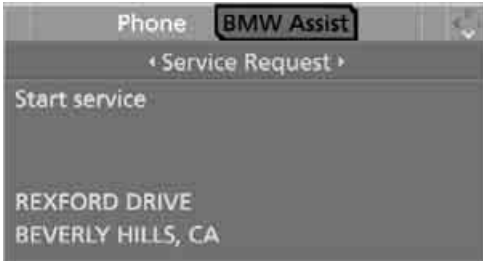

4. Select "Customer Relations".

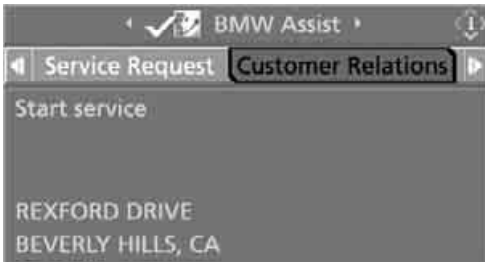

5. Press the controller.
6. Select "Start service" and press the controller.

You are connected to BMW Customer Relations by the BMW Assist Response Center.

Concierge service*

When you call the BMW Assist concierge service, you can, for example, obtain information on current events, filling stations or hotels and have their phone numbers and addresses transmitted. Many hotels can be booked directly through the BMW concierge service.

The concierge service must be enabled separately by the BMW Assist Response Center.

Calling up information

1. Press the **MENU** button.
This opens the start menu.
2. Move the controller forward to select "Communication".
3. Change to upper field if necessary. Turn the controller until "BMW Assist" is selected and press the controller.



4. Select "Concierge" and press the controller.

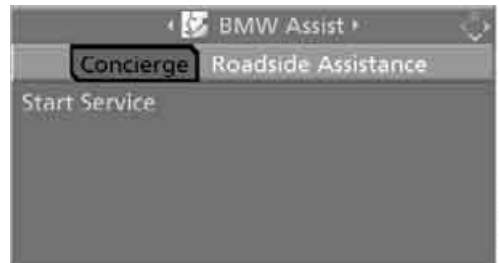

5. Select "Start Service" and press the controller.

The BMW Assist Response Center will connect you with a BMW Assist concierge.

Displaying transferred data

Select the received message if necessary and press the controller.



Dialing a phone number or transferring an address for destination guidance

1. Select "Options" and press the controller.



2. Select a menu item:
 - ▷ With "Call" you can establish a telephone connection. A prerequisite for this is that your Bluetooth mobile phone has been paired with the vehicle.
 - ▷ With "Select as destination" you can transfer the address to the navigation system for destination guidance.

Customizing BMW Assist

Displaying and updating services

You will be notified of any changes in the services offered by BMW Assist. In this case you should update the service functions.

1. Press the **MENU** button.
This opens the start menu.
2. Press the controller to open the **i** menu.

3. Turn the controller until "Settings" is selected and press the controller.



4. Turn the controller until "BMW Service settings" is selected and press the controller.



5. Change to upper field if necessary. Turn the controller until "Enabled services" is selected and press the controller. The currently available BMW Assist services are displayed.
6. Select "Options" and press the controller.

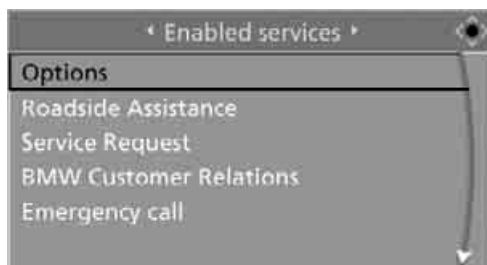

7. Select "Update services" and press the controller.

Blocking services*

If you block the services, the connection to BMW Assist is deactivated.

1. Press the **MENU** button.
This opens the start menu.
2. Press the controller to open the **i** menu.
3. Turn the controller until "Settings" is selected and press the controller.
4. Turn the controller until "BMW Service settings" is selected and press the controller.



5. Change to upper field if necessary. Turn the controller until "Enabled services" is selected and press the controller.
6. Select "Options" and press the controller.

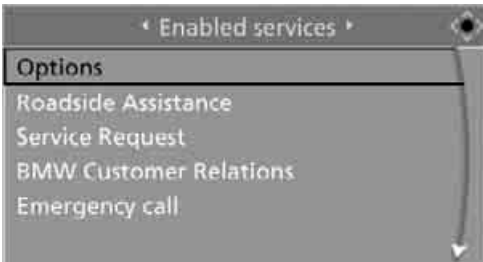

7. Select "Terminate services" and press the controller.

The use of BMW Assist is blocked, and the current vehicle position will not be transferred during an emergency request*. To cancel the blocking, and reactivate BMW Assist, see below. This does not affect the contractual agreements.

Reactivate BMW Assist if necessary to re-enable.

Activating BMW Assist

BMW Assist must be activated to use the services.

Requirements

- ▷ Make sure that the vehicle can determine its current position. Reception is best when you have an unobstructed view to the sky.
- ▷ Leave vehicle ignition switched on during the activation process.

Activating

1. Press the **MENU** button.
This opens the start menu.



2. Press the controller to open the **i** menu.
3. Turn the controller until "Settings" is selected and press the controller.



- Turn the controller until "BMW Service settings" is selected and press the controller.



- Change to upper field if necessary. Turn the controller until "Enabled services" is selected and press the controller.



- Select "Enable services" and press the controller. BMW Assist is enabled and the data exchange with the BMW Assist Response Center begins.

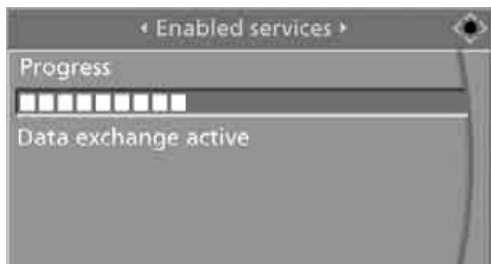

Activation takes a few minutes. The status is displayed on the Control Display. If you open another menu, the activation process continues to run in the background.

Displaying vehicle data

When BMW Assist is activated, the license plate and the vehicle identification number of your vehicle may be displayed.

- Open the start menu.
- Press the controller to open the **i** menu.
- Select "Settings" and press the controller.



- Select "BMW Service settings" and press the controller.



- Change to upper field if necessary. Turn the controller until "Profile" is selected and press the controller.







Mobility

This section helps you maintain your mobility by supplying important information on vital topics including fuels and lubricants, wheels and tires, service, maintenance and roadside assistance.

Refueling

⚠ Switch off the engine before refueling. When handling fuel, always observe all applicable precautionary measures and regulations. Never transport reserve fuel containers in the vehicle. These could become leaky and cause an explosion or a fire in an accident. ◀

Fuel filler door

Opening

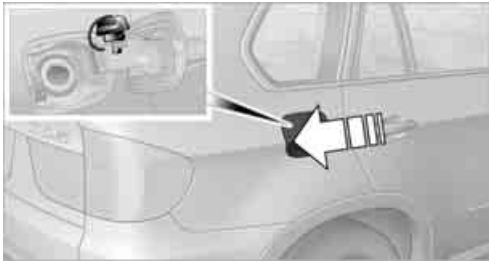

1. Open the fuel filler door. To do this, briefly press the lower edge.
2. Turn the fuel filler cap counterclockwise.
3. Place the fuel filler cap in the bracket attached to the fuel filler door.

Closing

Fit the cap and turn it clockwise until you clearly hear a click.

⚠ Do not crush the band attached to the cap; otherwise, the cap may not properly seal and fuel vapors can escape. ◀

A message* is displayed if the cap is loose or missing.

Releasing manually

If an electrical malfunction should occur, you can unlock the fuel filler door manually.

1. Open the right-hand side panel in the cargo bay.
2. Pull the knob with the gas pump symbol.

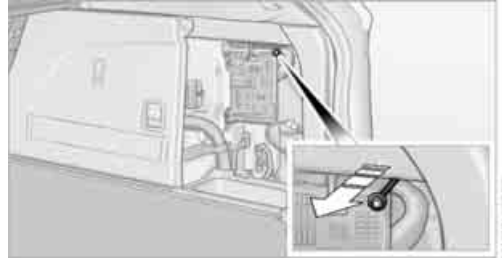

Observe the following when refueling

⚠ When handling fuels, follow the safety precautions posted at the filling station. Otherwise, there is a danger of personal injury or property damage. ◀

When refueling, insert the filler nozzle completely into the filler pipe. Avoid raising the filler nozzle during refueling, otherwise this leads to

- ▷ premature pump shutoff
- ▷ a reduced efficiency of the fuel-vapor recovery system.

The fuel tank is full when the filler nozzle clicks off the first time.

Fuel tank capacity

- ▷ X5 3.0si:
Approx. 22.5 US gal/85 liters, including the reserve capacity of approx. 2.1 US gal/8 liters
- ▷ X5 4.8i:
Approx. 22.5 US gal/85 liters, including the reserve capacity of approx. 2.6 US gal/10 liters

 Refuel as soon as possible once your cruising range falls below 30 miles/ 50 km, otherwise engine functions are not ensured and damage can occur. ◀

Fuel specifications

 Do not use leaded gasoline, otherwise damage to the catalytic converter will result.

Do not use E85, i.e. fuel that consists of 85% ethanol, or Flex Fuel, otherwise permanent damage to the engine and the fuel supply system will result. ◀

Required fuel

Super Premium Gasoline/AKI 91

This gasoline is highly recommended.

However, you may also use gasoline with less AKI. The minimum AKI Rating is 87.

If you use gasoline with this minimum AKI Rating, the engine may produce knocking sounds when starting at high outside temperatures. This has no effect on the engine life.

 Do not use gasoline below the specified minimum quality, otherwise engine damage can result. ◀

Use high-quality brands

Field experience has indicated significant differences in fuel quality: volatility, composition, additives, etc., among gasolines offered for sale in the United States and Canada. Fuels containing up to and including 10% ethanol or other oxygenates with up to 2.8% oxygen by weight, that is, 15% MTBE or 3% methanol plus an equivalent amount of co-solvent, will not void the applicable warranties with respect to defects in materials or workmanship.

 The use of poor-quality fuels may result in drivability, starting and stalling problems especially under certain environmental conditions such as high ambient temperature and high altitude.

Should you encounter drivability problems which you suspect could be related to the fuel you are using, we recommend that you respond by switching to a recognized high-quality brand such as gasoline that is advertised as Top Tier Detergent Gasoline.

Failure to comply with these recommendations may also result in unscheduled maintenance. ◀

Wheels and tires

Tire inflation pressure

Information for your safety

The condition of the tires and the maintenance of the specified tire pressure are crucial not only to the tire's service life, but also to driving comfort and most importantly, driving safety.

Checking pressure

Only check tire inflation pressure when the tires are cold. This means after a maximum of 1.25 miles/2 km driving or when the vehicle has been parked for at least 2 hours. When tires are warm, the tire inflation pressure increases.

 Check the tire inflation pressure regularly and correct it as needed, even on the compact tire*: at least twice a month and before starting long trips. If you fail to observe this precaution, you may be driving on tires with incorrect tire pressures, a condition that can not only compromise your vehicle's driving stability, but also lead to tire damage and the risk of an accident. Do not drive with depressurized, i.e. flat tires, except run-flat tires. A flat tire will seriously impair your vehicle's handling and braking response. Attempts to drive on a flat tire can lead to a loss of control over the vehicle. ◀

 After correcting the tire inflation pressure, reinitialize the Flat Tire Monitor, refer to page 92, or reset the Tire Pressure Monitor, refer to page 94. ◀

Pressure specifications

The tables below provide all the correct inflation pressures for the specified tire sizes at ambient temperature.

 The inflation pressures apply to the tire sizes and tire brands respectively approved and recommended by BMW; a list of these is available from your BMW Sports Activity Vehicle Center. ◀

For correct identification of the right tire inflation pressure for your tires, observe the following:

- ▷ Tire sizes of your vehicle
- ▷ Load conditions
- ▷ Maximum allowable driving speed

Tire inflation pressures for speeds up to 100 mph/160 km/h

For normal driving up to 100 mph/160 km/h, adjust pressures to the respective tire inflation pressures listed on the following pages in the column Traveling speeds up to max. of 100 mph/160 km/h to achieve optimum driving comfort.

These pressure specifications can be found on the door post when you open the driver's door.





 The permissible top speed for these tire inflation pressures is 100 mph/160 km/h. Do not exceed this speed, otherwise tire damage and accidents may result. ◀

Tire inflation pressures for speeds above 100 mph/160 km/h

 In order to drive at maximum speeds in excess of 100 mph/160 km/h, please observe, and, if necessary, adjust tire pressures for speeds exceeding 100 mph/160 km/h from the relevant table on the following pages. Otherwise tire damage and accidents could occur. ◀

Observe all national and local maximum speed limits, otherwise violations of the law could occur.

Tire inflation pressures for X5 3.0si/4.8i with two rows of seats

Tire size	Pressure specifications in psi/kPa					
	Traveling speeds up to a max. of 100 mph/160 km/h		Traveling speeds including those exceeding 100 mph/160 km/h			
All pressure specifications in the table are indicated in psi/kilopascal with cold tires. Cold = ambient temperature						
	Compact wheel*: T 155/90 R 18 113 M	61/420	61/420	61/420	61/420	61/420
without sport package:						
255/55 R 18 109 H M+S XL	32/220	32/220	32/220	32/220	32/220	38/260
255/50 R 19 107 H M+S XL	32/220	35/240	32/220	32/220	32/220	38/260
Front: 255/50 R 19 107 V XL	32/220	-	32/220	-	32/220	-
Rear: 285/45 R 19 111 V XL	-	32/220	-	32/220	-	35/240
Front: 275/40 R 20 106 W XL	32/220	-	32/220	-	32/220	-
Rear: 315/35 R 20 110 W XL	-	32/220	-	32/220	-	35/240
Front: 285/35 R 21 105 W XL	32/220	-	32/220	-	32/220	-
Rear: 325/30 R 21 108 W XL	-	32/220	-	32/220	-	38/260
with sport package:						
255/55 R 18 109 H M+S XL	32/220	32/220	32/220	32/220	32/220	38/260
255/50 R 19 107 H M+S XL	32/220	35/240	32/220	32/220	32/220	38/260
Front: 255/50 R 19 107 V XL	32/220	-	32/220	-	35/240	-
Rear: 285/45 R 19 111 V XL	-	32/220	-	32/220	-	38/260
Front: 275/40 R 20 106 W XL	32/220	-	32/220	-	35/240	-
Rear: 315/35 R 20 110 W XL	-	32/220	-	32/220	-	38/260
Front: 285/35 R 21 105 W XL	32/220	-	32/220	-	35/240	-
Rear: 325/30 R 21 108 W XL	-	32/220	-	35/240	-	41/280

More details on the permissible load and weights can be found on page [264](#).

Tire inflation pressures for X5 3.0si/4.8i with three rows of seats

Tire size	Pressure specifications in psi/kPa					
	Traveling speeds up to a max. of 100 mph/160 km/h			Traveling speeds including those exceeding 100 mph/160 km/h		
All pressure specifications in the table are indicated in psi/kilopascal with cold tires. Cold = ambient temperature						

without sport package:

255/55 R 18 109 H M+S XL	32/220	35/240	32/220	32/220	32/220	39/270
255/50 R 19 107 H M+S XL	32/220	38/260	32/220	35/240	35/240	42/290
Front: 255/50 R 19 107 V XL	32/220	-	32/220	-	32/220	-
Rear: 285/45 R 19 111 V XL	-	35/240	-	32/220	-	36/250
Front: 275/40 R 20 106 W XL	32/220	-	32/220	-	32/220	-
Rear: 315/35 R 20 110 W XL	-	35/240	-	32/220	-	36/250
Front: 285/35 R 21 105 W XL	32/220	-	32/220	-	32/220	-
Rear: 325/30 R 21 108 W XL	-	35/240	-	32/220	-	39/270

with sport package:

255/55 R 18 109 H M+S XL	32/220	35/240	32/220	32/220	32/220	39/270
255/50 R 19 107 H M+S XL	32/220	38/260	32/220	35/240	35/240	42/290
Front: 255/50 R 19 107 V XL	32/220	-	32/220	-	35/240	-
Rear: 285/45 R 19 111 V XL	-	35/240	-	35/240	-	39/270
Front: 275/40 R 20 106 W XL	32/220	-	32/220	-	35/240	-
Rear: 315/35 R 20 110 W XL	-	35/240	-	35/240	-	39/270
Front: 285/35 R 21 105 W XL	32/220	-	32/220	-	35/240	-
Rear: 325/30 R 21 108 W XL	-	35/240	-	35/240	-	42/290

More details on the permissible load and weights can be found on page [264](#).

Tire identification marks

Knowledge of the labeling on the side of the tire makes it easier to identify and choose the right tires.

Tire size

e.g. 255/55 R 18 109 H

Nominal width in mm ————
 Aspect ratio in % ————
 Belted construction – radial ————
 Rim diameter in inches ————
 Carrying capacity ID-code ————
 (not in ZR tires)
 Speed code letter ————
 (in ZR tires before the R)

Speed letter

Q = up to 100 mph/160 km/h

T = up to 118 mph/190 km/h

H = up to 131 mph/210 km/h

V = up to 150 mph/240 km/h

W = up to 167 mph/270 km/h

Y = up to 186 mph/300 km/h

Tire Identification Number

Tires with DOT codes meet the guidelines of the US Department of Transportation.

DOT code:

e.g. DOT xxxx xxx 0806

Manufacturer code
for tire make ————
 Tire size and tire design ————
 Tire age ————

Tire age

The manufacturing date of tires is contained in the tire coding: DOT ... 1207 indicates that the tire was manufactured in week 12 of 2007.

BMW recommends that you replace all tires after 6 years at most, even if some tires may last for 10 years.

Uniform Tire Quality Grading

Quality grades can be found where applicable on the tire sidewall between tread shoulder and maximum section width. For example:

Tread wear 200 Traction AA

Temperature A

DOT Quality Grades

Tread wear

Traction AA A B C

Temperature A B C



All passenger car tires must conform to Federal Safety Requirements in addition to these grades. ◀

Tread wear

The tread wear grade is a comparative rating based on the wear rate of the tire when tested under controlled conditions on a specified government test course. For example, a tire graded 150 would wear one and one-half (1 ½) times as well on the government course as a tire graded 100. The relative performance of tires depends upon the actual conditions of their use, however, and may depart significantly from the norm due to variations in driving habits, service practices and differences in road characteristics and climate.

Traction

The traction grades, from highest to lowest, are AA, A, B, and C.

These grades represent the tire's ability to stop on wet pavement, as measured under controlled conditions on specified government test surfaces of asphalt and concrete. A tire marked C may have poor traction performance.



The traction grade assigned to this tire is based on straight-ahead braking traction tests, and does not include acceleration, cornering, hydroplaning, or peak traction characteristics. ◀

Temperature

The temperature grades are A, the highest, B, and C, representing the tire's resistance to the generation of heat and its ability to dissipate heat when tested under controlled conditions on a specified indoor laboratory test wheel. Sustained high temperature can cause the material of the tire to degenerate and reduce tire life, and excessive temperature can lead to sudden tire failure. The grade C corresponds to a level of performance which all passenger car tires must meet under the Federal Motor Vehicle Safety Standard No. 109. Grades B and A represent higher levels of performance on the laboratory test wheel than the minimum required by law.

 The temperature grade for this tire is established for a tire that is properly inflated and not overloaded. Excessive speed, underinflation, or excessive loading, either separately or in combination, can cause heat buildup and possible tire failure. ◀

RSC – run-flat tires

You will recognize run-flat tires by a circular symbol containing the letters RSC on the side of the tire, refer to page 239.

M+S

Winter and all-season tires. These have better winter properties than summer tires.

XL

Indicates specially reinforced tires.

Tire condition

Inspect your tires frequently for tread wear, signs of damage and for foreign objects lodged in the tread. Check the tread depth.

Minimum tread depth

The tread depth should not drop below 0.12 in/ 3 mm, although, for example, European legislation only specifies a minimum tread depth of

0.063 in/1.6 mm. At tread depths below 0.12 in/ 3 mm there is an increased risk of high-speed hydroplaning, even when only small amounts of water are present on the road surface. When winter tires wear down past a tread depth of 0.16 in/4 mm, they become perceptibly less suitable for winter conditions. For the sake of safety, new tires should be installed.

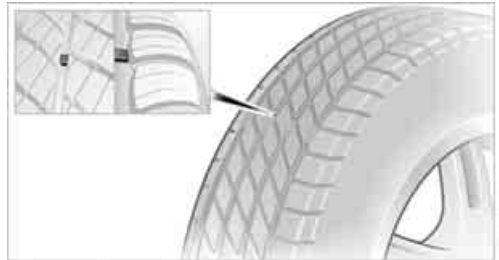

Wear indicators at the tread-groove base, refer to arrow, are distributed over the tire's circumference and are marked on the side of the tire with TWI – Tread Wear Indicator. If the tire tread has been driven down to the wear indicators, a tread depth of 0.063 in/1.6 mm has been reached.

Wheel/tire damage

Please note that low-profile tires cause wheels, tires and suspension parts to be more susceptible to road hazards and consequential damages.

Unusual vibrations encountered during normal vehicle operation can indicate tire failure or some other vehicle defect. This can, for example, be caused by driving over curbs. These kinds of problems may also be signaled by other changes in vehicle response, such as a strong tendency to pull to the left or right.

 In these cases, reduce speed immediately and have wheels and tires thoroughly checked. To do so, drive carefully to the nearest BMW Sports Activity Vehicle Center or tire shop that works according to BMW repair procedures with correspondingly trained personnel. If necessary, have the vehicle towed there. Otherwise, tire damage can be extremely dangerous to vehicle occupants and other road users. ◀

Run-flat tires



You will recognize run-flat tires by the circular symbol containing the letters RSC on the side of the tire.

Run-flat tires consist of partially self-contained tires and special rims. The sidewall reinforcement ensures that the tire retains some residual safety in the event of pressure drop and driving remains possible to a restricted degree.

To continue driving with a damaged tire:

- ▶ With Flat Tire Monitor, refer to Indication of a flat tire page [93](#)
- ▶ With Tire Pressure Monitor, refer to Message with low tire inflation pressure page [95](#)

New wheels and tires

 Have new wheels and tires installed only by your BMW Sports Activity Vehicle Center or a tire shop that works according to BMW repair procedures with correspondingly trained personnel. If this work is not carried out properly, there is a danger of subsequent damage and related safety hazards. Make sure that the new wheels are balanced. ◀

Retreaded tires

 BMW does not recommend that you use retreaded tires, as driving safety may be impaired. The causes for this include the possibly different tire casing structures and the often wide variations in their age, which can result in a limited service life. ◀

The right wheels and tires

When mounting new tires or changing over from summer to winter tires and vice versa, mount Run-Flat Tires for your own safety. Your BMW Sports Activity Vehicle Center will be happy to advise you.

 For safety reasons, BMW recommends that you do not have damaged run-flat tires repaired; they should be replaced. Otherwise it is not possible to rule out occurrences of consequential damage. ◀

 BMW recommends that you use only wheel and tire combinations that BMW has tested and approved for your particular vehicle. Variations in factors such as manufacturing tolerances mean that even wheels and tires with identical official size ratings could actually have different dimensions than the approved units – these differences could lead to body contact, and with it the risk of severe accidents. If non-approved wheels and tires are used, BMW cannot evaluate their suitability, and therefore cannot be held liable for driving safety. ◀

 When changing to larger wheels and tires, it may be necessary to make changes to the wheel-well trim piece, as otherwise road users could be endangered or the vehicle could be damaged. Only have this work carried out by a BMW Sports Activity Vehicle Center or a workshop that works in accordance with BMW guidelines and uses appropriately trained personnel. ◀

You can ask your BMW Sports Activity Vehicle Center for the correct wheel/tire combination.

The correct wheel/tire combination also affects various systems whose function would otherwise be impaired, e.g. ABS, DSC, xDrive or Flat Tire Monitor.

To maintain good handling and vehicle response, use only tires of a single tread configuration from a single manufacturer. Following tire damage, have the original wheel and tire combination remounted on the vehicle as soon as possible.

Wheels with electronics for TPM Tire Pressure Monitor

When mounting new tires or changing from summer to winter tires or vice versa, only use wheels with TPM electronics, otherwise the Tire Pressure Monitor cannot detect a flat tire, refer to page 94. Your BMW Sports Activity Vehicle Center will be happy to advise you on this subject.

Recommended tire brands

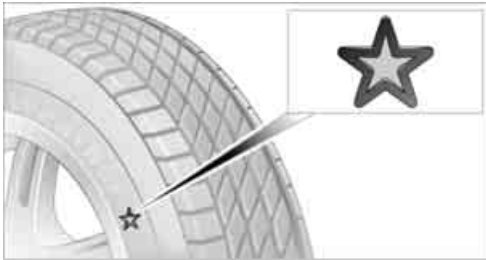

Certain tire makes are recommended by BMW depending on the tire size. You can recognize these from the clearly visible BMW marking on the tire sidewall.

When used properly, these tires comply with the most demanding standards for safety and vehicle response.

Special characteristics of winter tires

BMW recommends winter tires for use in cold winter driving conditions. Although all-season M+S tires provide better winter traction than summer tires, they generally fail to provide the same levels of cold-weather performance as winter tires.

Paying attention to speed

 Always observe the maximum permissible speed for the winter tires, otherwise tire damage may occur, which can result in accidents. ◀

Storage

Store wheels and tires in a cool, dry place with as little exposure to light as possible. Always protect tires against all contact with oil, grease and fuels. Do not exceed the maximum tire inflation pressure indicated on the side wall of the tire.

Rotating wheels between axles

BMW does not recommend moving the front wheels to the rear or vice versa, as otherwise the handling characteristics may be impaired.

Snow chains*

BMW only tests certain fine-link snow chains, classifies them as road-safe and recommends them. Your BMW Sports Activity Vehicle Center can provide you with this information.

Use is only permissible in pairs on the rear wheels.

Observe the manufacturer's instructions when mounting snow chains. Do not exceed a speed of 30 mph/50 km/h with the chains mounted.

 After mounting snow chains, do not initialize the Flat Tire Monitor*, as otherwise incorrect displays can occur.

When you are driving with snow chains, it can be beneficial to activate DTC briefly, refer to page 89. ◀

Under the hood

! Never attempt to perform any service or repair operations on your vehicle without the required professional technical training. If you do not know what repair procedures to follow, have work on your vehicle done only by your BMW Sports Activity Vehicle Center or a workshop that works according to BMW repair procedures with correspondingly trained personnel. If this work is not carried out properly, there is a danger of subsequent damage and related safety hazards. ◀

Hood

Releasing

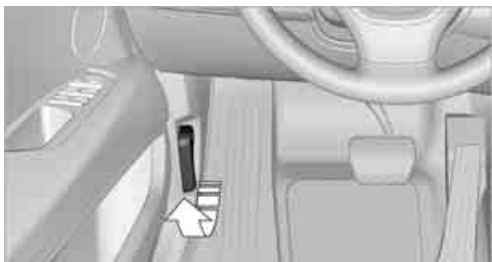

Pull lever.

Opening



Press the release handle and open the hood.

Closing



Close the hood from a height of approx. 16 in/ 40 cm with momentum. It must be clearly heard to engage.

! Make sure that the closing path of the hood is clear, otherwise injuries may result.

If you see any signs that the hood is not completely closed while driving your vehicle, you should stop at once and close it securely. ◀

Engine compartment

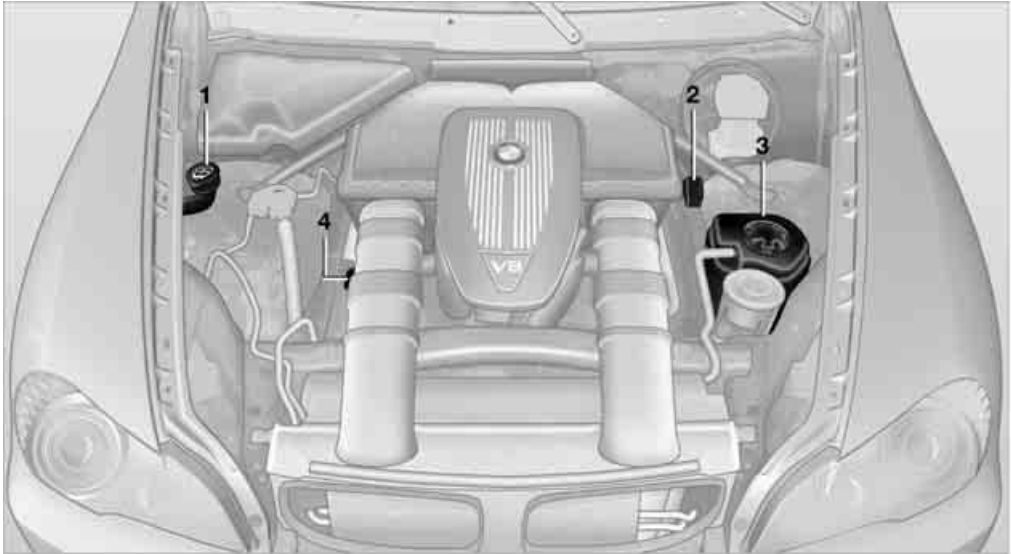

- 1 Filler neck for washer fluid of the headlamp and windshield cleaning systems, refer to page 68
- 2 Starting-aid terminal, refer to page 256
- 3 Expansion tank for coolant, refer to page 244
- 4 Filler neck for engine oil, refer to Adding engine oil on page 243

Engine oil

The engine oil consumption is dependent on driving style and driving conditions.

Checking engine oil level

Your vehicle is equipped with an electronic oil level check.

The condition for the most accurate indication of the oil level possible is measurement with the engine at operating temperature, i.e. following an uninterrupted drive of at least 6 miles/10 km. You can display the oil level while driving or when stopped on a level surface with the engine running.

iDrive, for operating principle refer to page 16.

1. Press the **MENU** button.
This opens the start menu.
2. Press the controller to open the **i** menu.

3. Select "Info sources" and press the controller.



4. Select "Service Info" and press the controller.

- Change to upper field if necessary. Turn the controller until "Service requirements" is selected and press the controller.



- Change to the second field from the top if necessary. Turn the controller until "Engine oil level" is selected and press the controller. The oil level is displayed.

Possible messages

- ▷ "Engine oil level O.K."
- ▷ "No measurement available: Updating engine oil level measurement...": Engine oil level is being measured. This process can take approx. 3 minutes when stopped on a level surface and approx. 5 minutes while driving.
- ▷ "Oil level at the minimum! Refill with 1 quart of engine oil.": Add 1 US quart/liter of engine oil at the next opportunity.
- ▷ "Engine oil level too high":
 -  Have the vehicle checked immediately, otherwise engine damage may result if too much oil has been added. ◀
- ▷ "Please observe recalculated service interval for engine oil": Do not add engine oil. Before continuing to drive, note the recalculated remaining mileage until the next oil change service, refer to Service requirements on page 75. Have the system checked as soon as possible.

Adding engine oil

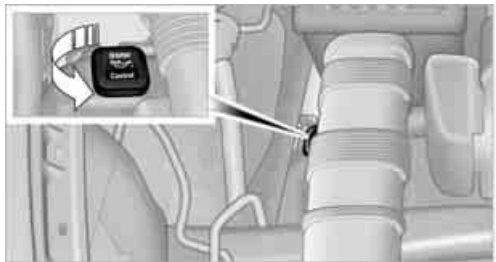

Do not add 1 US quart/liter of oil until a corresponding message is shown on the Control Display.

 Add oil within the next 125 miles/200 km, otherwise the engine could be damaged. ◀

 Continuous exposure to used oil has caused cancer in laboratory testing. For this reason, any skin areas that come into contact with oil should be thoroughly washed with soap and water. Keep oil, grease etc. out of reach of children and observe the warnings on the containers to prevent health risks. ◀

Oil change

Only have an oil change carried out by a BMW Sports Activity Vehicle Center or a workshop that works in accordance with BMW guidelines and uses appropriately trained personnel.

Approved engine oils

The quality of the engine oil selected has critical significance for the operation and service life of an engine. BMW continuously approves specific oils after confirming their suitability for use in its vehicles with extensive testing.

 Do not use oil additives, as these may result in engine damage. ◀

Only use approved BMW High Performance Synthetic Oil.

If BMW High Performance Synthetic Oil is unavailable, you can add small quantities of other synthetic oils between oil changes. Only use oils of the specification API SM or higher.

 Your BMW Sports Activity Vehicle Center will be happy to answer detailed questions on BMW High Performance Synthetic Oil or approved synthetic oils.

You can also call BMW of North America at 1-800-831-1117 or visit the website at www.bmwusa.com to obtain this information.

Viscosity grades

Viscosity is a measure of an oil's flow rating and is specified in SAE grades.

The choice of the right SAE grade is based on the climatic conditions in the region in which you normally drive your BMW.

 Approved oils belong to the SAE grades 5W-40 and 5W-30.

These oils can be used for driving at all outside temperatures.

BMW recommends 

Coolant

 Do not add coolant to the cooling system when the engine is hot. Escaping coolant can cause burns. ◀

Coolant is composed of equal parts water and a coolant additive. Not all commercially available additives are suitable for your BMW. Your BMW Sports Activity Vehicle Center can recommend suitable additives.

 Only use suitable additives, otherwise engine damage may result. The additives present a health hazard; observe the instructions on the containers. ◀

 Comply with the appropriate environmental protection regulations when disposing of coolant additives. ◀

Checking coolant level

1. Do not open the hood until the engine has cooled down.
2. Turn the cap of the expansion tank counterclockwise to allow any accumulated pressure to escape, then continue turning to open.
3. The coolant level is correct when the coolant level is between the MIN and MAX marks, refer to the diagram adjacent to the filler neck.
4. If the coolant is low, slowly add coolant up to the specified level; do not overfill.
5. Turn the cap until there is an audible click.
6. Have the reason for the coolant loss eliminated as soon as possible.

Maintenance

BMW maintenance system

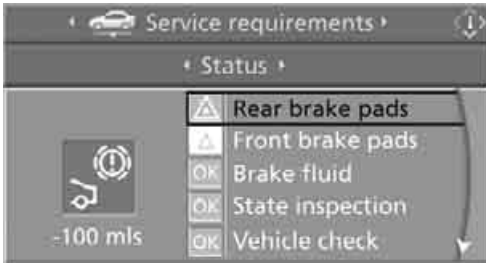

The BMW maintenance system supports the preservation of the traffic and operating safety of your BMW. The service schedule also includes operations related to the vehicle's comfort and convenience features, such as replacement of the filters for the inside air. The ultimate objective is to ensure economical maintenance by providing the ideal service for your vehicle.

Should the day come when you decide to sell your BMW, a complete dealer service history will prove to be an asset of inestimable value.

CBS Condition Based Service

Sensors and special algorithms take the different driving conditions of your BMW into account. Condition Based Service uses this to determine the current and future service requirements. By letting you define a service and maintenance regimen that reflects your own individual requirements, the system builds the basis for trouble-free driving.

You can set the Control Display to show remaining distances and times of selected maintenance intervals and legally mandated deadlines, refer to page 75:

- ▷ Engine oil
- ▷ Brake pads, front and rear separately
- ▷ Brake fluid

- ▷ Vehicle check
- ▷ Legally mandated inspections depending on local regulations

Service data in remote control

Your vehicle stores the information required for maintenance continuously in the remote control during driving. After accessing the data stored in the remote control, your BMW Service Advisor can suggest precisely the right array of service procedures for your own individual vehicle. You should therefore hand over the remote control you last used to drive to the BMW Service Advisor when you take your vehicle in for service.

 Make sure the date is set correctly, refer to page 82, otherwise the effectiveness of CBS Condition Based Service is not ensured. ◀

Service and Warranty Information Booklet for US models and Warranty and Service Guide Booklet for Canadian models

Please consult your Service and Warranty Information Booklet for US models and Warranty and Service Guide Booklet for Canadian models for additional information on service requirements.

 BMW recommends that you have service and repair operations performed at your BMW Sports Activity Vehicle Center. Take the time to ensure that these service procedures are confirmed by entries in your vehicle's Service and Warranty Information Booklet for US models and Warranty and Service Guide Booklet for Canadian models. These entries verify that your vehicle has received the specified regular maintenance. ◀

Socket for OBD Onboard Diagnostics interface

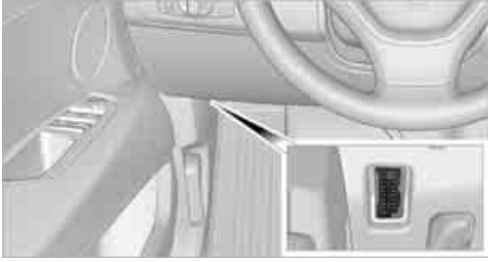

Components which are decisive for the exhaust-gas composition can be checked via the OBD socket with a device.

This socket is located to the left on the driver's side, on the underside of the instrument panel under a cover.

Exhaust-gas values

SERVICE
ENGINE
SOON



The warning lamp lights up.

The exhaust-gas values worsen.

Have the vehicle checked as soon as possible.



Display of the previously described malfunction in Canadian models.



The lamp flashes under certain conditions. This is a sign of excessive misfiring of the engine. In this case you should reduce your speed and proceed to the nearest BMW Sports Activity Vehicle Center. Heavy engine misfiring causes serious damage to the emission-relevant components, especially the catalytic converter, within a short time.

 If the fuel filler cap is not properly tightened, the OBD system will assume that fuel vapor escapes. Then a display lights up. If the cap is then tightened, the display will go out within a few days.

Event Data Recorders

Your vehicle may be equipped with one or several measuring and diagnosis modules, or with a device for recording or transmitting certain vehicle data or information. If you have also subscribed to BMW Assist, certain vehicle data can be transmitted or recorded to enable corresponding services.

Care

Important information on the care and maintenance of your BMW is contained in the Caring for your vehicle brochure.

Replacing components

Onboard toolkit



The onboard toolkit is located in the cargo bay under the floor panel.

Replacing wiper blades

Front

1. Fold down the wiper arm.
2. Swing the wiper blade upward.
3. Remove the wiper blade toward the windshield, refer to arrow.

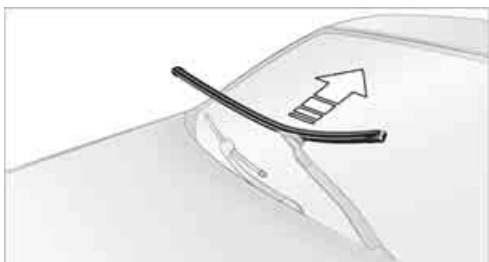

Rear



1. Lift off the wiper arm completely and pull off the wiper blade, refer to arrow.
2. Mount the new wiper blade and press on until it is heard to engage.

Lamps and bulbs

Lamps and bulbs make an essential contribution to vehicle safety. You must be duly diligent in replacing them. BMW recommends having your BMW Sports Activity Vehicle Center perform any work that you do not feel competent to perform yourself or that is not described here.

⚠ Never touch the glass of new bulbs with your bare fingers, as even minute amounts of contamination will burn into the bulb's surface and reduce its service life. Use a clean cloth, napkin, etc., or hold the bulb by its metal socket. ◀

A replacement bulb set is available from your BMW Sports Activity Vehicle Center.

⚠ Only replace bulbs when cool, as otherwise you may be burned. ◀

⚠ Whenever you perform any work on the electrical system, turn off the systems/consumers involved to prevent short circuits from occurring. To avoid possible injury or equipment damage when replacing bulbs, observe any instructions provided by the bulb manufacturer. ◀

For care and maintenance of the headlamps, please follow the instructions in the separate Caring for your vehicle brochure.

 For bulbs for which replacement is not described and for checking and adjusting headlamp aim, please contact your BMW Sports Activity Vehicle Center. ◀

Light-emitting diodes LEDs

Light-emitting diodes installed behind translucent lenses serve as the light source for many of the controls and displays in your vehicle. These light-emitting diodes, which operate using a concept similar to that applied in conventional lasers, are officially designated as Class 1 light-emitting diodes.

 Do not remove the covers, and never stare into the unfiltered light for several hours, as irritation of the retina could result. ◀

Xenon bulbs

The service life of these bulbs is very long and the probability of a failure is very low, provided that they are not switched on and off an unusual number of times. If one of these bulbs should nevertheless fail, it is possible to continue driving with great caution using the fog lamps, provided traffic laws in your area do not prohibit this.

 Have work on the xenon light unit including changing the bulb carried out only by your BMW Sports Activity Vehicle Center or a workshop that works according to BMW repair procedures with correspondingly trained personnel. Due to the high voltage present in the system, there is a danger of fatal injuries when work is carried out improperly. ◀

Halogen bulbs: Parking and daytime running lamps

H8 bulb, 35 watts

 The bulb is pressurized. Therefore, wear safety glasses and protective gloves. Otherwise there is a danger of injuries if the bulb is accidentally damaged during replacement. ◀

1. Turn the cover to the left and remove.

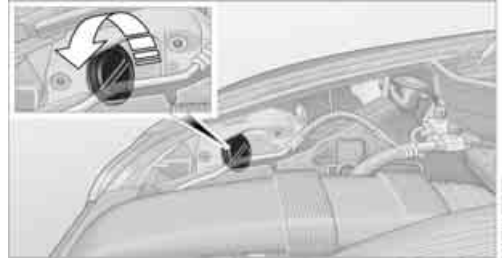

2. Turn the bulbs to the left, pull off the connector and replace.
3. Install in the reverse order.

Turn signals, front

24-watt bulb, PSY24W

1. Unscrew bulb holder with bulb to the left, refer to arrow, and replace.

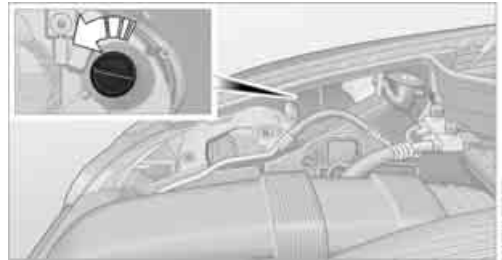

2. Install in the reverse order.

Side marker lamps, rear

To replace, please go to a BMW Sports Activity Vehicle Center or a workshop that works according to BMW repair procedures with correspondingly trained personnel.

Tail lamps

- ▷ Turn signals, brake lamps:
21-watt bulb, P21W
- ▷ Backup lamps and brake force display:
16-watt bulb, W16W
- ▷ Rear lamp: LED technology.
In case of a defect, please go to a BMW Sports Activity Vehicle Center or a workshop that works according to BMW repair procedures with correspondingly trained personnel.

Arrangement of tail lamps

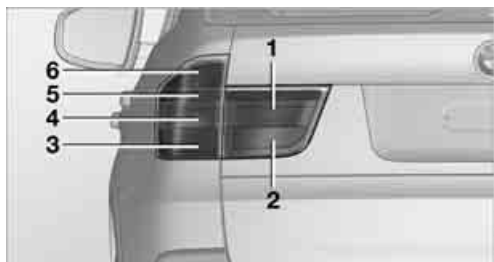

- 1 Rear lamp
- 2 Brake force display
- 3 Turn signal
- 4 Brake lamp/rear lamp/side marker lamp
- 5 Backup lamp
- 6 Brake lamp

Brake lamp

1. Open the side panel in the cargo bay.
2. Remove the first-aid kit* and warning triangle* if necessary. Fold up the insulation.
3. Turn the bulb socket concerned to the left and remove.



4. Remove the upper bulb for replacement. Apply gentle pressure to the lower bulb while turning it to the left for removal and replacement.
5. Remount the side panel.

Turn signal

1. Open the side panel in the cargo bay.
2. Remove the first-aid kit* and warning triangle* if necessary. Fold up the insulation.
3. Turn the bulb socket to the left and remove.



4. Apply gentle pressure to the bulb while turning it to the left for removal and replacement.
5. Remount the side panel.

Backup lamp

1. Open the side panel in the cargo bay.
2. Remove the first-aid kit* and warning triangle* if necessary. Fold up the insulation.
3. Turn the bulb socket to the left and remove.



4. Remove the bulb for replacement.
5. Remount the side panel.

Brake force display

1. Carefully remove the cap in the cover of the liftgate with a screwdriver.

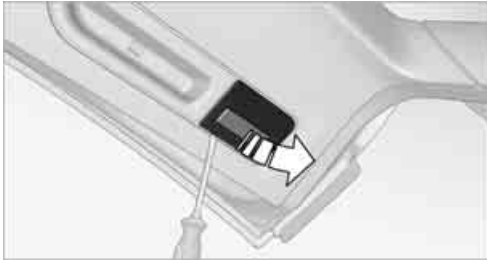

2. Turn the bulb socket to the left and remove.

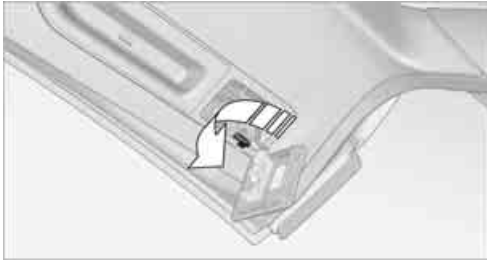

3. Apply gentle pressure to the bulb while turning it to the left for removal and replacement.
4. Insert the bulb socket in the liftgate and engage it.
5. Before installing the cap, unclip the cargo bay lamp. Then lay the cap on its upper side and close it, refer to arrow.



6. Position the cargo bay lamp and clip it in, refer to arrow.

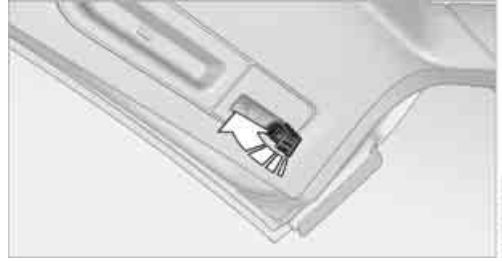

License plate lamp

5-watt bulb, C11 12W

1. Slide the lamp to the right with a screwdriver, refer to arrow 1.



2. Remove the lamp, arrow 2.
3. Replace the bulb.
4. Reinstall the lamp.

Center brake lamp

This lamp uses LED technology for operation. In case of a defect, please go to a BMW Sports Activity Vehicle Center or a workshop that works according to BMW repair procedures with correspondingly trained personnel.

Changing wheels

Your BMW is equipped with run-flat tires as standard. As a result, it is not necessary to change the wheel immediately in the case of air loss in the event of a breakdown.

To continue driving with a damaged tire:

- ▶ With Flat Tire Monitor, refer to Indication of a flat tire page 93
- ▶ With Tire Pressure Monitor, refer to Message with low tire inflation pressure page 95

You will recognize run-flat tires by a circular symbol containing the letters RSC on the side of the tire, refer to Run-flat tires, page 239.

When mounting new tires, or changing from summer to winter tires or vice versa, use run-flat tires for your own safety. No spare tire is available in case of a flat tire. Your BMW Sports Activity Vehicle Center will be happy to advise you. Also refer to New wheels and tires, page 239.

 Suitable tools for changing tires are available as accessories at your BMW Sports Activity Vehicle Center. ◀

Jacking points for vehicle jack

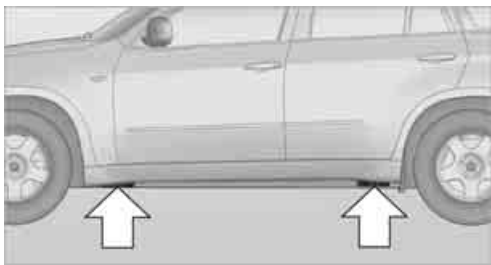

The jacking points for the vehicle jack are located in the positions shown.

Compact wheel*

 Safety precautions in the event of a flat tire or wheel change: park the vehicle as far as possible from passing traffic and on solid ground. Switch on the hazard warning flashers. Set the parking brake and engage transmission position P.

Have all vehicle occupants get out of the vehicle

and ensure that they remain outside the immediate area in a safe place, such as behind a guardrail.

If a warning triangle* or portable hazard warning lamp* is required, set it up on the roadside at an appropriate distance from the rear of the vehicle. Comply with all safety guidelines and regulations.

Change the wheel only on a level, firm surface which is not slippery. The vehicle or the jack could slip to the side if you attempt to raise the vehicle on a soft or slippery surface such as snow, ice, tiles, etc.

Position the jack on a firm support surface. Do not use a wooden block or similar object as a support base for the jack, as this would prevent it from extending to its full support height and reduce its load-carrying capacity.

To avoid serious or fatal injury: never lie under the vehicle, and never start the engine while it is supported by the jack. ◀

What you will need

To avoid rattling noises later on, note the positions of the tools before removing them, then return them to their initial positions after completing work.

The tools are located in the mount under the floor panel flap.

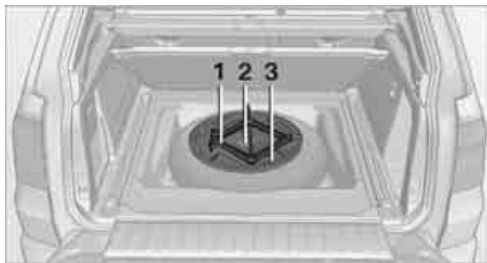

- 1 Vehicle jack*
- 2 Vehicle jack crank*
- 3 Lug wrench*

Removing compact wheel

The compact wheel is located in the cargo bay under the floor panel.



1. Remove the tool mount.
2. Unscrew the wing nut 1.
3. Remove the washer 2 laterally.
4. Remove the compact wheel.

Preparing wheel change

1. Observe the safety precautions above.
2. Loosen the lug bolts a half turn.

Jacking up vehicle

1. Position the vehicle jack at the jacking point closest to the wheel so that the entire surface of the jack base rests on the ground perpendicularly beneath the jacking point.

 The vehicle jack is designed for changing wheels only. Do not attempt to raise another vehicle model with it or to raise any load of any kind. To do so could cause accidents and personal injury. ◀

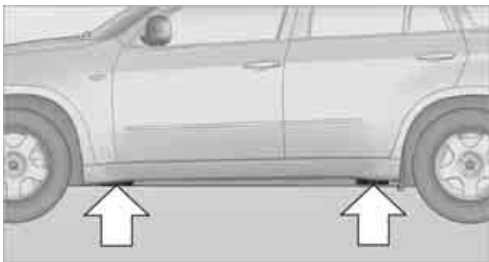

2. Guide the jack head into the rectangular recess of the jacking point when cranking up, refer to illustration detail.



3. Jack the vehicle up until the wheel you are changing is raised from the ground.

Mounting a wheel

1. Unscrew the lug bolts and remove the wheel.
2. Remove accumulations of mud or dirt from the mounting surfaces of the wheel and hub. Also clean the lug bolts.
3. Position the new wheel or compact wheel. Secure the wheel by screwing at least two lug bolts into opposite bolt holes. When you mount wheels other than Genuine BMW light-alloy wheels, different lug bolts may also be required.
4. Screw in the remaining lug bolts. Tighten all the bolts securely in a diagonal pattern.
5. Lower the vehicle and remove the jack from beneath the vehicle.

After mounting

1. Tighten the lug bolts in a diagonal pattern.

 To ensure safety, always have the lug bolts checked with a calibrated torque wrench as soon as possible to ensure that they are tightened to the specified torque. Otherwise, incorrectly tightened lug bolts are a hidden safety risk. The tightening torque is 101 lb ft/140 Nm. ◀

2. Stow the defective wheel in the cargo bay.

 The defective wheel cannot be stored under the floor panel flap due to its size. ◀

3. Check and correct the tire inflation pressure at the earliest opportunity.



Protect valve stems with valve screw caps against dirt and contamination. Dirt in valve stems is a frequent source of gradual air loss. ◀

4. Initialize the Flat Tire Monitor, refer to page 92, or reset the Tire Pressure Monitor, refer to page 94.
5. Replace the damaged tire as soon as possible and have the new wheel/tire balanced.

Driving with compact wheel

Drive reservedly and do not exceed a speed of 50 mph/80 km/h.

The driving characteristics change, for example reduced track stability on braking, extended braking distance, and altered self-steering characteristics in the limit range. In conjunction with winter tires, these characteristics are more pronounced.



Only one compact wheel may be mounted. Restore the wheels and tires to their original size as quickly as possible. Failure to do so is a safety risk. ◀

Vehicle battery

Battery care

The battery is 100% maintenance-free, i.e., the electrolyte will last for the life of the battery when the vehicle is operated in a temperate climate. Your BMW Sports Activity Vehicle Center will be glad to advise in all matters concerning the battery.

Charging battery

Only charge the battery in the vehicle via the terminals in the engine compartment with the engine switched off. Connections, refer to Jump starting on page 256.

Disposal



Have old batteries disposed of following replacement at your BMW Sports Activity Vehicle Center or bring them to a collection point. Maintain the battery in an upright position for transport and storage. Always restrain the battery to prevent it from tipping over during transport. ◀

Power failure

After a temporary power loss, the functioning of some equipment may be limited and require reinitialization. Individual settings are also lost and must be updated:

- ▷ Seat, mirror and steering wheel memory
The positions must be stored again, refer to page 44.
- ▷ Time and Date
The values must be updated, refer to pages 81, 82.
- ▷ Radio
Stations must be stored again if necessary, refer to page 168.
- ▷ Navigation system
Wait until the system starts, refer to page 159.

Fuses



Never attempt to repair a blown fuse and do not replace a defective fuse with a substitute of another color or amperage rating, as this could lead to a circuit overload, ultimately resulting in a fire in the vehicle. ◀

Spare fuses, a pair of plastic tweezers and information on the fuse assignment are located near the fuses in the cargo bay.

In interior

The fuses are located in the front passenger footwell on the underside of the instrument panel.

1. Unscrew screws, refer to arrows, of footwell trim panel.



2. Lay the trim panel in the footwell.
3. Unscrew the screw, arrow 1, and fold down the fuse carrier, arrow 2.

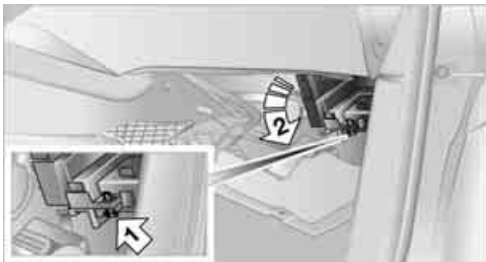

4. Replace the fuse concerned.
5. Installation is carried out in the reverse order of removal. Ensure correct and secure attachment of the footwell trim panel in the process.

In cargo bay



Open the right-hand side panel in the cargo bay.

Giving and receiving assistance

Emergency request

Conditions for an emergency request:

- ▶ Full preparation package mobile phone.
With this equipment, an emergency request is still possible when no mobile phone is paired in the vehicle.
- ▶ BMW Assist is activated.
Activating BMW Assist, refer to page 228.
- ▶ Radio readiness is switched on.
- ▶ The BMW Assist system is logged in on a wireless communications network.
- ▶ The emergency request system is operable.

When the contract of participation with BMW Assist expires, the BMW Assist system can be deactivated by a BMW Sports Activity Vehicle Center without having to visit a workshop. Once the BMW Assist system has been deactivated, emergency requests are not possible. The BMW Assist system be reactivated by a BMW Sports Activity Vehicle Center after signing a new contract.

Initiating an emergency request

1. Briefly press protective cover to open.
Depending on the vehicle's equipment, the arrangement of the switches and indicator lamps may differ somewhat.



2. Press the SOS button for at least 2 seconds.

The LED in the button lights up. As soon as the voice connection to the BMW Assist Response Center has been established, the LED flashes.

When the emergency request is received at the BMW Assist Response Center, the BMW Assist Response Center contacts you and takes further steps to help you. Even if you are unable to answer, the BMW Assist Response Center can take further steps to help you under certain conditions.

If conditions allow, remain in the vehicle until the connection has been established. You will then be able to provide a detailed description of the situation.

If the current position of your vehicle can be determined, it will be forwarded to the BMW Assist Response Center.

If the LED flashes, but you are unable to hear the BMW Assist Response Center through the hands-free system, this could indicate, for instance, that the hands-free system is no longer operational. However, you may then still be audible for the BMW Assist Response Center.

Under certain conditions, an emergency request is automatically initiated immediately after a severe accident. The automatic collision notification is not affected by the button being pressed.

 For technical reasons, the emergency request cannot be guaranteed under unfavorable conditions. ◀

Warning triangle*

The warning triangle is located in the cargo bay.

First-aid kit*

Some of the articles contained in the first-aid kit have a limited service life. Therefore, check the expiration dates of the contents regularly and replace the contents concerned in good time if necessary.



The first-aid kit is located in the cargo bay. Open the left-hand side panel.

Roadside Assistance*

The BMW Roadside Assistance offers you assistance in the event of a breakdown around the clock, including on weekends and public holidays.

The phone numbers of the Roadside Assistance in your home country can be found in the Contact brochure.

With BMW Assist or TeleService, you can contact BMW Roadside Assistance for assistance in the event of a breakdown directly via iDrive, refer to page 224.

Jump starting

When your battery is discharged, you can use two jumper cables to start your BMW with power from the battery in a second vehicle. You can also use the same method to help start another vehicle. Use only jumper cables with fully-insulated clamp handles.

 To avoid the risk of potentially fatal injury, always avoid all contact with electrical components while the engine is running. Carefully adhere to the following sequence, both to prevent damage to one or both vehicles, and to guard against possible personal injuries. ◀

Preparation

1. Check whether the battery of the other vehicle has a voltage of 12 Volts and approximately the same capacitance in Ah. This information can be found on the battery.
2. Switch off the engine of the assisting vehicle.
3. Switch off any electrical systems and components in both vehicles.

 There must not be any contact between the bodies of the two vehicles, otherwise there is a danger of shorting. ◀

Connecting jumper cables

 To avoid personal injury from sparks, follow this sequence when connecting jumper cables. ◀

On your BMW the so-called starting-aid terminal in the engine compartment acts as the battery positive terminal, also refer to the engine compartment overview on page 242. The cover cap is marked with +.

1. Fold open the cover of the BMW starting-aid terminal. To do so, pull the tab.

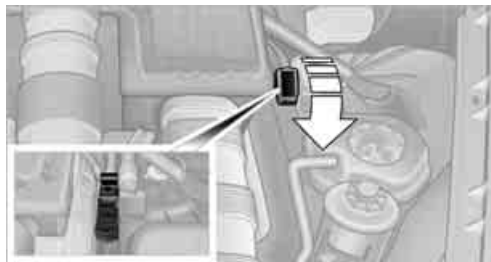

2. Attach one end of the jumper cable plus/+ to the positive terminal of the battery or a starting-aid terminal of the vehicle providing assistance.

- Attach the second end of the cable to the positive terminal of the battery or to a starting-aid terminal of the vehicle to be started.
- Attach one end of the jumper cable minus/- to the negative terminal of the battery or to an engine or body ground of the assisting vehicle.
Your BMW has a special nut as body ground or negative pole.



- Attach the second end of the cable to the negative terminal of the battery or to the engine or body ground of the vehicle to be started.

Starting engine

- Start the engine on the assisting vehicle and allow it to run at idle for several minutes at slightly increased speed.
- Start the engine on the other vehicle in the usual way.
If the first starting attempt is not successful, wait a few minutes before another attempt in order to allow the discharged battery to recharge.
- Let the engines run for a few minutes.
- Disconnect the jumper cables by reversing the connection sequence.

Check the battery and recharge if necessary.

- Never use spray fluids to start the engine. ◀

Tow-starting and towing

- Observe applicable laws and regulations for tow-starting and towing. ◀
- Do not transport any passengers other than the driver in a vehicle that is being towed.

Using tow fitting

The screw-on tow-fitting must always be carried in the vehicle. It can be screwed in at the front or rear of the BMW.

It is located in the toolkit under the floor panel flap in the cargo bay, refer to page 247.

- Use only the tow fitting provided with the vehicle and screw it all the way in. Use the tow fitting for towing only on roads. Avoid lateral loading of the tow fitting, e.g. do not lift the vehicle by the tow fitting. Otherwise damage to the tow fitting and the vehicle can occur. ◀

Access to screw thread

Cover panel in bumper: press on the arrow symbol on the cover panel.

Front

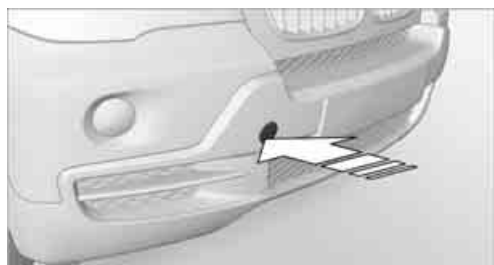

Rear

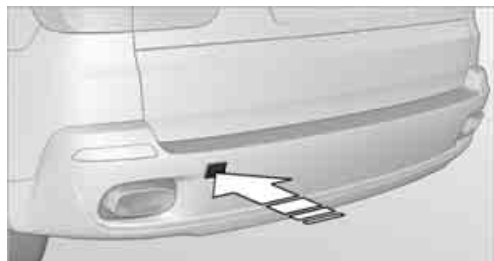

Being towed

⚠ Make sure that the ignition is switched on, refer to page 59, otherwise the low beams, tail lamps, turn signals and windshield wipers would not be available. When the engine is stopped, there is no power assist. This then requires increased effort for braking and steering. Active steering is deactivated and larger steering wheel movements are required. ◀

Switch on the hazard warning flashers depending on the local regulations. If the electrical system fails, mark the vehicle to be towed, e.g. with a sign or warning triangle in the rear window.

Engage transmission position N and release the parking brake before towing.

If transmission position N cannot be engaged, manually release the transmission lock, refer to page 65.

⚠ Do not exceed a towing speed of 45 mph/70 km/h and a towing distance of 90 miles/150 km, otherwise the automatic transmission may be damaged. ◀

Towing methods

⚠ Do not lift vehicle by tow fitting or body and chassis parts, otherwise damage may result. ◀

In some countries, towing with tow bars or ropes in public traffic is not permitted. Familiarize yourself with the regulations on towing in the respective country.

With tow bar

⚠ The towing vehicle may not be lighter than the vehicle to be towed, otherwise it will not be possible to reliably control vehicle response. ◀

The tow fittings used should be on the same side on both vehicles. Should it prove impossible to avoid mounting the tow bar at an offset angle, please observe the following:

- ▷ Clearance and maneuvering capability will be sharply limited during cornering.
- ▷ When mounted at an angle, the tow bar will exert lateral forces, tending to push the vehicle sideways.

⚠ Only attach the tow bar to the tow fittings, as attachment to other vehicle parts can lead to damage. ◀

With tow rope

When starting off in the towing vehicle, make sure that the tow rope is taut.

⚠ To avoid jerking and the associated stresses on vehicle components when towing, always use nylon ropes or nylon straps. Only attach tow ropes to the tow fittings, as attachment to other vehicle parts can lead to damage. ◀

With tow truck

⚠ Do not tow the X5 with the front or rear axle raised individually, otherwise the wheels may lock and the transfer case may be damaged. ◀

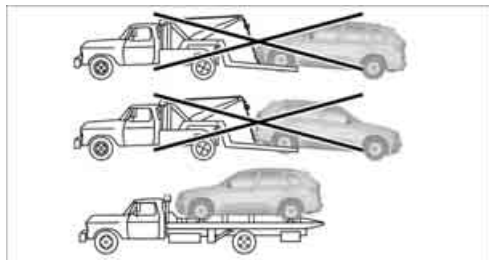

The X5 may only be transported on a flat bed.

Tow-starting

The engine cannot be started by tow-starting. Start the engine by jump starting it, refer to page 256.

Have the cause of the starting difficulties eliminated.



Reference

This chapter contains the technical data, the short commands of the voice command system, and the index that will direct you as quickly as possible to the information you are looking for.

Technical data

Engine data

		X5 3.0si	X5 4.8i
Displacement	cu in/cm ³	182.8/2,996	292.9/4,799
No. of cylinders		6	8
Maximum output	hp	260	350
at engine speed	rpm	6,600	6,300
Maximum torque	lb ft/Nm	225/305	350/475
at engine speed	rpm	2,750	3,400-3,800

Dimensions

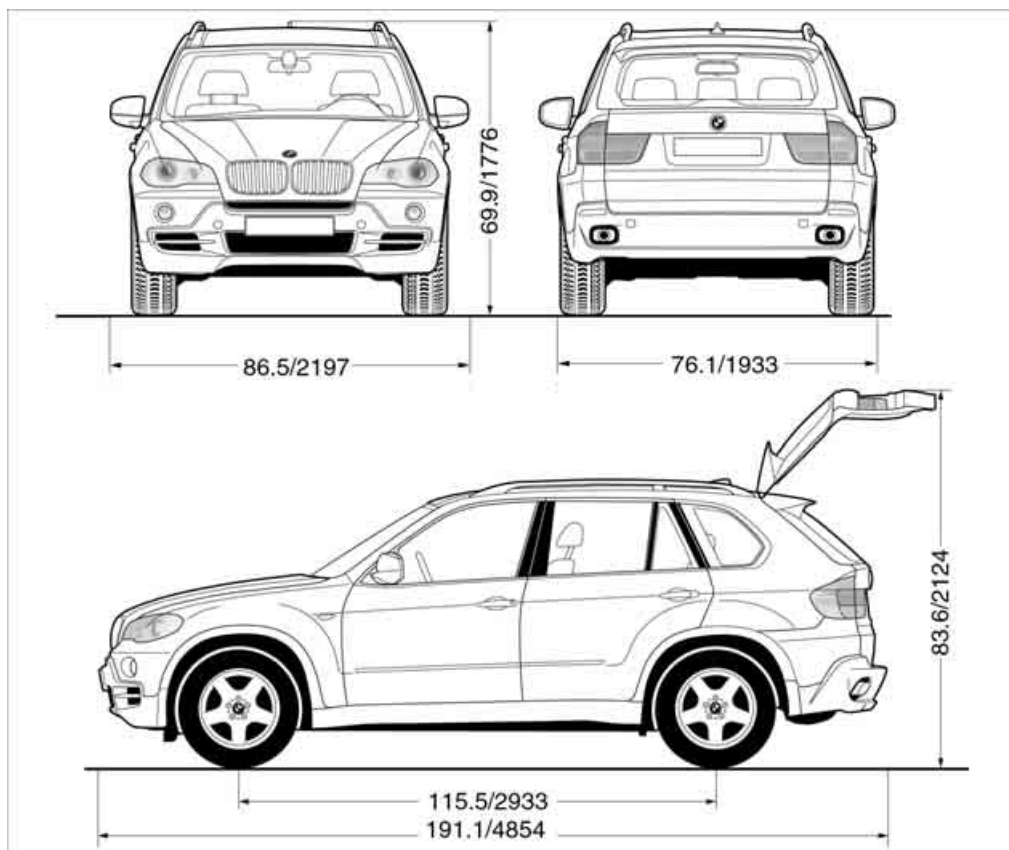

All dimensions given in inches/mm.

Smallest turning circle diam.: 42,0 ft/12.8 m

With mixed tires* the vehicle width may exceed the specified dimension.

Weights

		X5 3.0si	X5 4.8i
Curb weight with 3rd row seats	lbs./kg	4,916/2,230	5,247/2,380
Approved gross vehicle weight	lbs./kg	6,327/2,870	6,537/2,965
without 3rd row seats	lbs./kg	6,008/2,725	6,173/2,800
Load	lbs./kg	1,411/640	1,290/585
without 3rd row seats	lbs./kg	1,268/575	1,102/500
Approved front axle load	lbs./kg	2,767/1,255	3,020/1,370
without 3rd row seats	lbs./kg	2,778/1,260	3,020/1,370
Approved rear axle load	lbs./kg	3,803/1,725	3,869/1,755
without 3rd row seats	lbs./kg	3,395/1,540	3,395/1,540
Approved roof load capacity	lbs./kg	220/100	220/100
Cargo bay capacity	cu ft/l	21.9-61.8/620-1,750	21.9-61.8/620-1,750

Never exceed either the approved axle loads or the gross vehicle weight.

Capacities

			Notes
Fuel tank	US gal/liters	approx. 22.5/85	Fuel grade: page 233
of that reserve			
X5 3.0si	US gal/liters	approx. 2.1/8	
X5 4.8i	US gal/liters	approx. 2.6/10	
Windshield washer with headlamp washer system	US quarts/liters	approx. 6.9/6.5	For more details: page 68

Short commands of voice command system*

With short commands you can carry out certain functions directly, regardless of which menu item is selected.

Here are the important short commands for the voice command system.

Assistance window

Function	Command
To open assistance window 20	›Assistance window⟨
To select display in assistance window 20	›Assistance window map facing north⟨, ›Assistance window map direction of travel⟨, ›Assistance window arrow display⟨, ›Assistance window perspective⟨, ›Assistance window current position⟨, ›Assistance window trip computer⟨ or ›Assistance window onboard info⟨
To change scale in assistance window 152	›Assistance window scale ... feet⟨ or ›Assistance window scale ... miles⟨

Communication

Function	Command
To open phone 209	›Phone⟨
To dial phone number 215	›Dial number⟨
To display phone book 216	›A to Z⟨
To dial from phone book 216	›Call ...⟨ or ›Dial name⟨
To display "Top 8" 217	›Top 8⟨
To redial 216	›Redial⟨
To display "Received calls" 217	›Received calls⟨
To display "Missed calls" 217	›Missed calls⟨
To display "Bluetooth" 212	›Bluetooth⟨
To open BMW Assist 224	›BMW Assist⟨
To open "BMW Service" 224	›BMW Service⟨
To open "BMW Contact" 217	›BMW Contact⟨
To open "BMW Contact Numbers" 217	›BMW Contact numbers⟨
To open "Roadside Assistance" 224	›Roadside Assistance⟨

Navigation

Function	Command
To open navigation system 138	›Navigation‹
To open "Enter address" 139	›Enter address‹
To open "New destination" 139	›New destination‹
To display "Input map" 143	›Input map‹
To display destination list 145	›Destination list‹
To display address book 146	›Address book‹
To display route criteria 148	›Route preference‹
To start destination guidance 150	›Start guidance‹
To end destination guidance 150	›Stop guidance‹
To display arrow display 151	›Arrow display‹
To display map display 152	›Map‹, ›Map facing north‹, ›Map direction of travel‹ or ›Perspective‹
To change scale 152	›Scale ... miles‹ or ›Scale ... feet‹
To display roads or towns/cities along route 152	›Route list‹
To switch on voice instructions 153	›Navigation info on‹
To switch off voice instructions 153	›Navigation info off‹
To repeat voice instructions 153	›Repeat navigation info‹
To open route 148, 152	›Route menu‹
To open "New route" 154	›New route‹
To display current position 157	›Current position‹

Onboard info

Function	Command
To open "Car Data" 73	›Car data‹
To display computer 73	›Onboard info‹
To display trip computer 74	›Trip computer‹
To open stopwatch 80	›Stopwatch‹
To open speed limit 80	›Limit‹
To activate speed limit 80	›Limit on‹
To deactivate speed limit 80	›Limit off‹

Entertainment

Function	Command
Tone control 163	›Audio‹
To switch on radio 166	›Radio on‹, ›FM‹ or ›AM‹
To open "FM" 166	›FM menu‹
To open "AM" 166	›AM menu‹
To open "All stations" 166	›FM All stations‹
To select radio station 166	›Station ...‹, e.g. ›Station WNYC‹ or ›Choose station‹
To open "Presets" 166	›FM presets‹ or ›AM presets‹
To select stored radio station 166	›Preset ...‹, e.g. ›Preset 1‹
To open "Manual" 167	›FM manual‹, ›AM manual‹ or ›Choose frequency‹, ›Frequency ... Megahertz‹
To open strongest radio stations 167	›AM Autostore‹
To open "WB" 171	›Weatherband menu‹
To switch on weatherband 171	›Weatherband on‹
To select a weatherband station 171	›Choose weatherband station‹
To open "SAT" 172	›SAT radio menu‹
To switch on satellite radio 172	›SAT radio‹
To open "Presets" of satellite radio 173	›SAT radio presets‹
To open "All channels" of satellite radio 173	›SAT radio all channels‹
To open "Categories" of satellite radio 173	›SAT radio categories‹
To open CD player 175	›CD menu‹
To switch on CD player 175	›CD‹
To open CD changer 175	›CD-changer menu‹
To switch on CD changer 175	›CD-changer‹
To select CD 175	›CD 1...6‹
To select music track 176	›CD track ...‹
To select CD and music track 176	›CD 1...6 track ...‹
To switch on audio playback with external audio device 188	›Audio Aux‹

Climate

Function	Command
To adjust temperature distribution for front seat heating 50	›Seat heater distribution‹
To open "Vent settings" 109	›Vent settings‹
To open "Automatic programs" 107	›Automatic programs‹
To open "Parked car ventilation" 113	›Parked car operation‹
To open "Automatic ventilation" 113	›Automatic ventilation‹
To display activation times 114	›Activation time‹

i menu

Function	Command
To open the i menu	›Settings menu‹
"Display off" 21	›Display off‹
To open "Info sources"	›Info sources‹
To open "Settings"	›Settings‹
To open "Door locks" 29	›Door locks‹
To open "Steering wheel buttons" 53	›Steering wheel buttons‹
To open "Lighting" 67	›Lighting‹
To open "Service requirements" 75	›Service requirements‹
To open "Service" 75	›Service‹
To open "BMW Service" 224	›BMW service settings‹
To display "Check Control messages" 79	›Check Control messages‹
To open "Head-Up Display" 99	›Head-up display‹
To set brightness of Control Display 82	›Brightness‹
To open "Units" 82	›Units‹
To open "Language" 83 , 153	›Language‹
To open "Time" 82	›Time‹
To open "Date" 82	›Date‹
To open "PDC" 84	›PDC‹
To open "FTM" 92	›FTM‹
To open "TPM" 94	›TPM‹
To display "Bluetooth" 213	›Bluetooth‹
To open "HDC" 90	›HDC‹

Everything from A to Z

Index

"..." Identifies Control Display texts used to select individual functions, and indicates where to find them in the text.

A

- ABS Antilock Brake System [88](#)
- Accessories [6](#)
- Access to 3rd row seats [48](#)
- Acoustic signal, refer to Check Control [78](#)
- Activated-charcoal filter [111](#)
- "Activation time" for parked car ventilation [114](#)
- Active seat [51](#)
- Active seat ventilation [50](#)
- Active steering [96](#)
 - warning lamp [96](#)
- Adaptive brake lamps, refer to Brake force display [97](#)
- Adaptive Drive [91](#)
- Adaptive fastening system [124](#)
- Adaptive Head Light [104](#)
- "Add digits" for mobile phone [216](#)
- "Address book" for navigation system [146](#)
- Address for navigation
 - deleting [147](#)
 - entering [139, 146](#)
 - selecting [147](#)
 - storing [146](#)
 - storing current position [146](#)
- "Add to destination list" [141, 143](#)
- Adjusting confirmation signals for locking and unlocking [31](#)
- Adjusting temperature with expanded-scope automatic climate control [108](#)
- Adjusting the tone during audio operation, refer to Tone control [163](#)
- Adjusting thigh support [43, 44](#)
- "After door opened" [45](#)
- "After unlocking" [45](#)
- Airbags [97](#)
 - sitting safely [42](#)
 - warning lamp [99](#)
- Air circulation, refer to Air recirculation [109](#)
- Air distribution
 - automatic [107, 112](#)
 - manual [108](#)
- Airing, refer to Ventilation [110](#)
- Air recirculation
 - AUC Automatic recirculated-air control [109](#)
 - recirculated-air mode [109](#)
- "Air recirculation on / off" [53](#)
- Air vents [106](#)
 - refer to Ventilation [110](#)
- Air vents of automatic climate control [106](#)
- Air volume [108, 112](#)
- AKI, refer to Fuel specifications [233](#)
- Alarm system [35](#)
 - avoiding unintentional alarms [36](#)
 - interior motion sensor [36](#)
 - switching off alarm [35](#)
 - switching off tilt alarm sensor and interior motion sensor [36](#)
 - tilt alarm sensor [36](#)
- "All channels", with satellite radio [173](#)
- "All doors" [30](#)
- All-season tires, refer to Winter tires [240](#)
- "All stations", displaying with radio [166](#)
- All-wheel drive, refer to xDrive [90](#)
- Alterations, technical, refer to For your own safety [5](#)
- "AM", reception range [163, 166](#)
- "Angle of view" for DVD system in rear [185, 197](#)
- Antenna for mobile phone [208](#)
- Antifreeze
 - coolant [244](#)
 - washer fluid [68](#)
- Antilock Brake System ABS [88](#)
- Anti-theft system
 - refer to Alarm system [35](#)
 - refer to Central locking system [29](#)
- Approved axle loads, refer to Weights [264](#)
- Approved engine oils [243](#)
- Approved gross vehicle weight, refer to Weights [264](#)
- Armrest, refer to Center armrest [119](#)
- Around the center console [14](#)
- Around the steering wheel [10](#)
- Arrival time
 - refer to Computer [73](#)
 - refer to Starting destination guidance [150](#)
- "Arrow display" for navigation system [151](#)
- Arrow view for navigation system [151](#)
- Ashtray
 - front [120](#)
 - rear [121](#)

Assist, refer to separate operating instructions
Assistance systems, refer to
 Driving stability control systems **88**
Assistance window **20**
"Assist. window off" **21**
AUC Automatic recirculated-air control **109**
"Audio" **165, 169**
– for DVD system in rear **204**
Audio **162**
– controls **162**
– switching on/off **162**
– tone control **163**
– volume **163**
Audio CD for DVD system in rear **198**
Audio device, external **119**
Automatic
– air distribution **107, 112**
– air volume **107, 112**
– headlamp control **102**
– liftgate operation **34**
– service notification **225**
– steering wheel adjustment, refer to Easy entry/exit **53**
– storing stations **167**
Automatic car washes **130**
– also refer to Caring for your vehicle brochure
Automatic climate control **107**
– automatic air distribution **107, 112**
– in rear **111**
– switching off **110, 112**
– ventilation in rear **111**
Automatic closing of doors, refer to Automatic soft closing **33**
Automatic curb monitor **52**
Automatic garage door opener **115**
Automatic Hold **61**
– activating **62**
– deactivating **62**
– parking **62**

Automatic lighting
– refer to Automatic headlamp control **102**
– refer to Daytime running lamps **103**
– refer to Interior lamps **105**
– refer to Pathway lighting **103**
"Automatic programs" **108**
Automatic recirculated-air control AUC **109**
Automatic soft closing **33**
Automatic station search **167**
Automatic transmission with Steptronic **64**
– deactivating selector lever interlock **64**
– kick-down **65**
– manually releasing transmission lock **65**
– tow-starting **258**
– with comfort access **37**
"Automatic ventilation" **113**
AUTO program for automatic climate control **107, 112**
"Auto Request" **225**
"Autostore" on the radio **168**
"AUX" **163, 188, 190**
– AUX-In connection **188**
– for DVD system in rear **203**
– USB audio interface **189**
"AUX / Rear" **194**
AUX-In connection **119, 188**
Average fuel consumption **73**
– setting units **82**
Average speed, refer to Computer **73**
"Avoid ferries" for navigation system **149**
"Avoid highways" for navigation system **148**
Avoiding highways for navigation **148**
Avoiding unintentional alarms **36**
"Avoid tollroads" for navigation system **149**
Axle loads, refer to Weights **264**
"A - Z" **216**

B

Backrest contour, refer to Lumbar support **44**
Backrests, refer to Seats **43**
Backrest width adjustment **44**
Backup lamps, replacing bulbs **249**
Balance, refer to Tone control **164**
"Balance" for DVD system in rear **197**
Band-aids, refer to First-aid kit **256**
Bass, refer to Tone control **163**
Battery
– charging **253**
– jump starting **256**
– power failure **253**
– refer to Vehicle battery **253**
Battery disposal
– remote control with comfort access **38**
– vehicle battery **253**
Battery replacement
– remote control for DVD system in rear **194**
– remote control with comfort access **38**
Being towed **258**
Belts, refer to Safety belts **48**
Beverage holder, refer to Cup holders **120**
Blower, refer to Air volume **108, 112**
"BMW Assist" **224, 225, 226**
BMW Assist
– activating **228**
– concierge service **226**
– contacting BMW Customer Relations **226**
– offered services **223**
– roadside assistance **224**
– TeleService **225**
"BMW Contact" **218**
"BMW Contact Numbers" **218**

BMW homepage [4](#)
 BMW maintenance system [245](#)
 "BMW Service settings" [229](#)
 BMW website [4](#)
 Body roll, refer to Driving on poor roads [133](#)
 Bottle holder, refer to Cup holders [120](#)
 Brake assistant [89](#)
 Brake force display [97](#)
 Brake lamps
 – brake force display [97](#)
 – replacing bulbs [249](#)
 Brake rotors [130](#)
 Brakes
 – ABS Antilock Brake System [88](#)
 – brake assistant [89](#)
 – brake force display [97](#)
 – breaking-in [128](#)
 – CBC Cornering Brake Control [88](#)
 – electronic brake-force distribution [88](#)
 – parking brake [60](#)
 – refer to Braking safely [129](#)
 – warning lamp [13](#)
 Brake system [128](#)
 – brake pads [128](#)
 – breaking-in [128](#)
 – disk brakes [130](#)
 Braking safely [129](#)
 Breakdown, Flat Tire Monitor [92](#)
 Breakdown services, refer to Roadside Assistance [256](#)
 Breaking-in brake pads [128](#)
 Breaking-in differential [128](#)
 Break-in period [128](#)
 "Brightness" [82](#)
 – for DVD system in rear [196](#)
 – in TV mode [184](#)
 Brightness
 – of Control Display [82](#)
 – of the rear view camera [88](#)
 – on Head-Up Display [100](#)
 "Brightness / Position" [100](#)

Button for starting engine [59](#)
 Buttons on steering wheel [11](#)
 Bypassing traffic congestion [157](#)

C

Calibrating driver's seat [49](#)
 California Proposition 65 Warning [6](#)
 "Call" [216](#), [227](#)
 Call
 – accepting [214](#)
 – displaying accepted [217](#)
 – ending [215](#)
 – in absence [217](#)
 – starting [215](#)
 Calling
 – from phone book [216](#)
 – from Top 8 list [217](#)
 – redialing [217](#)
 – refer to telephone operating instructions
 Camera, refer to Rear view camera [86](#)
 "Camera picture and PDC" [88](#)
 "Camera view
 – full screen" [88](#)
 – main window" [88](#)
 Can holder, refer to Cup holders [120](#)
 Capacities [264](#)
 Capacity of cargo bay [264](#)
 Car battery, refer to Vehicle battery [253](#)
 Car care, refer to Caring for your vehicle brochure
 Car-care products, refer to Caring for your vehicle brochure
 "Car Data" [73](#)
 Care [246](#)
 – refer to Caring for your vehicle brochure
 Cargo
 – refer to Loading [131](#)
 – securing [132](#)
 – securing with ski bag [125](#)
 Cargo area, refer to Cargo bay [122](#)
 Cargo area cover, refer to Roll-up cover [122](#)
 Cargo bay
 – capacity [264](#)
 – emergency operation, refer to Opening manually [33](#)
 – expanding [123](#)
 – opening/closing, refer to Liftgate [33](#)
 – opening/closing, refer to Tailgate [35](#)
 – opening from inside [33](#)
 – opening from outside [33](#)
 – opening with remote control [30](#)
 Cargo bay cover, refer to Roll-up cover [122](#)
 Caring for artificial leather, refer to Caring for your vehicle brochure
 Caring for leather, refer to Caring for your vehicle brochure
 Caring for light-alloy wheels, refer to Caring for your vehicle brochure
 Caring for the carpet, refer to Caring for your vehicle brochure
 Caring for the vehicle finish, refer to Caring for your vehicle brochure
 Car key, refer to Keys/remote control [28](#)
 Car phone [208](#)
 – installation location, refer to Center armrest [119](#)
 – refer to Mobile phone [208](#)
 – refer to separate operating instructions
 Car radio, refer to Radio [166](#)
 Car wash [130](#)
 – also refer to Caring for your vehicle brochure
 – before driving in [60](#)
 – with comfort access [37](#)

Catalytic converter, refer to Hot exhaust system [129](#)
"Categories", with satellite radio [173](#)
CBC Cornering Brake Control [88](#)
CBS Condition Based Service [245](#)
"CD" [163](#), [175](#)
– for DVD system in rear [194](#)
CD, refer to Playing audio tracks, DVD system in rear [198](#)
CD/DVD player, DVD system in rear [193](#)
CD changer [175](#)
– compressed audio files [175](#)
– controls [162](#)
– fast forward/reverse [178](#)
– random sequence [178](#)
– repeating a track [177](#)
– sampling tracks [177](#)
– selecting a CD [175](#)
– selecting a track [176](#)
– switching on/off [162](#)
– tone control [163](#)
– volume [163](#)
CD player [175](#)
– compressed audio files [175](#)
– controls [162](#)
– fast forward/reverse [178](#)
– random sequence [178](#)
– repeating a track [177](#)
– sampling tracks [177](#)
– selecting a track [176](#)
– switching on/off [162](#)
– tone control [163](#)
– volume [163](#)
Cell phone, refer to Mobile phone
Center armrest [119](#)
Center brake lamp [250](#)
Center console [14](#)
"Central locking" [30](#)
Central locking system [29](#)
– comfort access [36](#)
– from inside vehicle [32](#)

Changes, technical
– refer to For your own safety [5](#)
– refer to Parts and accessories [6](#)
Changing language on Control Display [83](#)
Changing tires [239](#)
Changing units of measure on Control Display [82](#)
Changing wheels [251](#)
Check Control [78](#)
"Check Control messages" [79](#)
Checking the air pressure, refer to Tire inflation pressure [234](#)
Children, transporting [55](#)
Child restraint fixing system LATCH [56](#)
Child restraint systems [55](#)
Child-safety locks [58](#)
Child seats [55](#)
Chime, refer to Check Control [78](#)
Chrome parts, care, refer to Caring for your vehicle brochure
Cigarette lighter, refer to Lighter [121](#)
Cleaning, refer to Caring for your vehicle brochure
"Climate" [50](#)
Clock [71](#)
– 12h/24h mode [82](#)
– setting time [81](#)
Closing
– from inside [32](#)
– using remote control [29](#)
Closing fuel filler cap [232](#)
Clothes hooks [119](#)
Cockpit [10](#)
Cold start, refer to Starting engine [60](#)
"Color" for DVD system in rear [196](#)
Comfort access [36](#)
– observe in car wash [37](#)
– replacing battery [38](#)

Comfort area, refer to Around the center console [14](#)
Comfort start, refer to Starting engine [60](#)
"Communi- cation" [214](#), [224](#), [225](#), [226](#)
Compact Disc
– refer to CD changer [175](#)
– refer to CD player [175](#)
Compact wheel
– inflation pressure [235](#)
– wheel change [251](#)
Compartment for remote control, refer to Ignition lock [59](#)
Compartments, refer to Storage compartments [119](#)
Compass, digital [117](#)
Computer [73](#)
– displays in instrument panel [73](#)
– displays on Control Display [73](#)
– trip computer [74](#)
"Concierge" [226](#)
Concierge service [226](#)
Condition Based Service CBS [245](#)
"Confirmation" [31](#)
Connecting car vacuum cleaner, refer to Connecting electrical devices [121](#)
Connecting headphones [193](#)
Consumption, refer to Average fuel consumption [73](#)
Consumption indicator, Energy Control [72](#)
Consumption statistics, refer to Average fuel consumption [73](#)
"Continue guidance to destination?" [151](#)
"Contrast"
– for DVD system in rear [196](#)
– in TV mode [184](#)
Control Center, refer to iDrive [16](#)

- Control Display, refer to iDrive [16](#)
 - setting brightness [82](#)
 - Controller, refer to iDrive [16](#)
 - Controls, refer to Cockpit [10](#)
 - Controls of DVD system in rear [192](#)
 - Convenient operation
 - panorama glass sunroof [30, 32](#)
 - panorama glass sunroof with comfort access [37](#)
 - windows [30, 32](#)
 - windows with comfort access [37](#)
 - with comfort access [37](#)
 - Coolant [244](#)
 - checking level [244](#)
 - temperature [72](#)
 - Cooling, maximum [109](#)
 - Cornering Brake Control CBC [88](#)
 - Courtesy lamps, refer to Interior lamps [105](#)
 - Cradle for telephone or mobile phone [119](#)
 - Cruise control [69](#)
 - Cruising range [73](#)
 - Cup holders [120](#)
 - Curb weight, refer to Weights [264](#)
 - Current fuel consumption [72](#)
 - "Current position" [157](#)
 - Current position
 - displaying [157](#)
 - entering [146](#)
 - storing [146](#)
 - "Customer Relations" [218, 226](#)
 - Cylinders, refer to Engine data [262](#)
- D**
- Dashboard, refer to Cockpit [10](#)
 - Data [262](#)
 - capacities [264](#)
 - dimensions [263](#)
 - engine [262](#)
 - technical data [262](#)
 - weights [264](#)
 - "Date" [82](#)
 - Date [71](#)
 - display format [82](#)
 - retrieving [71](#)
 - setting [82](#)
 - "Date format" [82](#)
 - "Daytime running lamps" [103](#)
 - Daytime running lamps [103](#)
 - "Deactivated" [45](#)
 - Decommissioning the vehicle, refer to Caring for your vehicle brochure
 - Defrosting windows [108](#)
 - Defrosting windows and removing condensation [108](#)
 - Defrost position, refer to Defrosting windows [108](#)
 - "Delete address book" for navigation system [147](#)
 - "Delete all numbers" on the mobile phone [217](#)
 - "Delete data" for navigation system [147](#)
 - "Delete" for mobile phone [217](#)
 - Destination address
 - deleting [147](#)
 - entering [139, 141](#)
 - Destination for navigation
 - destination list [145](#)
 - entry [138](#)
 - selecting from address book [147](#)
 - selecting using information [144](#)
 - selecting using voice [141](#)
 - storing [146](#)
 - Destination guidance [150](#)
 - canceling voice instructions [54](#)
 - changing specified route [148](#)
 - displaying route [151](#)
 - distance and arrival [150](#)
 - ending/continuing [150](#)
 - starting [150](#)
 - voice instructions [153](#)
 - volume of voice instructions [154](#)
 - Destination list for navigation system [145](#)
 - Destinations recently driven to [145](#)
 - "Details"
 - DVD system in the rear [200](#)
 - in audio mode [190](#)
 - "Dial" for mobile phone [215](#)
 - "Dial number" [215](#)
 - "Diamond button" [54](#)
 - Digital clock [71](#)
 - Digital compass [117](#)
 - Digital radio, refer to High Definition Radio [169](#)
 - Dimensions [263](#)
 - Directional indicators, refer to Turn signals [66](#)
 - Direction instructions, refer to Voice instructions [153](#)
 - Directory for navigation, refer to Address book [146](#)
 - Direct selection buttons [21](#)
 - Displacement, refer to Engine data [262](#)
 - "Display" [82](#)
 - Display, refer to iDrive [16](#)
 - Displaying images [200](#)
 - Display lighting, refer to Instrument lighting [105](#)
 - "Display off" [21](#)
 - Displays, refer to Instrument panel [12](#)
 - "Display settings" [82, 99](#)
 - Displays on the windshield, refer to Head-Up Display [99](#)

Disposal
– battery of remote control with comfort access **38**
– remote control battery **194**
– vehicle battery **253**
Distance, refer to
 Computer **73**
"Distance to dest." **74**
Distance to destination, refer to Computer **73**
Distance warning, refer to PDC Park Distance Control **84**
Door entry lighting **105**
Door key, refer to Keys/remote control **28**
Door lock **31**
Door locking, confirmation signals **31**
"Door locks" **30, 31, 76**
Doors
– manual operation **32**
– remote control **29**
DOT Quality Grades **237**
Downhill driving assistance, refer to HDC **90**
Draft-free ventilation **110**
Drinks holder, refer to Cup holders **120**
"Driver's door only" **30**
Driver's seat, calibrating **49**
"Driver's seat climate" **51**
Driving lamps, refer to Parking lamps/low beams **102**
Driving on poor roads **133**
Driving route, refer to Displaying route **151**
Driving stability control systems **88**
Driving through water **129**
Driving tips, refer to General driving notes **128**
Dry air, refer to Cooling function **109**
Drying the air, refer to Cooling function **109**

DSC Dynamic Stability Control **89**
– indicator lamp **13, 89**
DTC Dynamic Traction Control **89**
– activating **89**
– indicator lamp **90**
"DVD" **182**
– for DVD system in rear **194**
DVD changer
– fast forward **183**
– reverse **183**
– skip chapter **183**
"DVD format" for DVD system in rear **197**
DVD for navigation **136**
DVD system in rear **192**
– CD/DVD player **193**
– connecting headphones **193**
– controls **192**
– displaying images from CD/DVD **200**
– DVD country codes **195**
– external device **203**
– information on CD/DVD player **202**
– playing audio tracks from CD/DVD **198**
– playing video from CD/DVD **195**
– remote control **193**
– switching on/off **194**
"Dynamic route" for navigation **149**
Dynamic Stability Control DSC **89**
Dynamic Traction Control DTC **89**

E

Easy entry/exit **53**
Electrical malfunction
– automatic transmission with Steptronic **65**
– door lock **32**
– driver's door **32**
– fuel filler door **232**
– liftgate **33**
– panorama glass sunroof **40**
– parking brake **63**
Electric seat **43**
Electric steering wheel adjustment **52**
Electronic brake-force distribution **88**
Electronic oil level check **242**
Emergency operation, refer to Manual operation
– door lock **32**
– driver's door **32**
– fuel filler door **232**
– liftgate **33**
– transmission lock, automatic transmission **65**
Emergency request **255**
Emergency services, refer to Roadside Assistance **256**
"Enabled services" **229**
"Enable services" **229**
"End call" **216**
Energy-conscious driving, refer to Energy Control **72**
Energy Control **72**
Engine
– breaking-in **128**
– data **262**
– overheated, refer to Coolant temperature **72**
– speed **262**
– starting **60**
– starting, with comfort access **37**
– switching off **60**
Engine compartment **242**
Engine coolant **244**

Engine oil
 – adding **243**
 – additives, refer to Approved engine oils **243**
 – approved engine oil **243**
 – checking oil level **242**
 – electronic oil level check **242**
 "Engine oil level" **243**
 Engine output, refer to Engine data **262**
 Engine overheating, refer to Coolant temperature **72**
 Engine speed **262**
 Engine starting, refer to Starting engine **60**
 "Enter address" **139**
 Entering country of destination **139**
 Entering destination **139**
 Entering house number or intersection **140**
 Entering intersection **140**
 Entering street **140**
 "Entertainment" **162**
 Entertainment sound output on/off **163**
 "Equalizer", refer to Tone control **165**
 Equalizer, refer to Tone control **165**
 "ESN" **172**
 ESP Electronic Stability Program, refer to DSC Dynamic Stability Control **89**
 Event Data Recorders **246**
 Exhaust system, refer to Hot exhaust system **129**
 Exterior mirrors **51**
 – adjusting **51**
 – automatic dimming feature **52**
 – automatic heating **52**
 – folding in and out **51**
 – tilting down passenger-side exterior mirror **52**

External audio device **119**
 – refer to AUX-In connection **188**
 Eye for tow-starting and towing, refer to Tow fitting **257**

F

Fader, refer to Tone control **164**
 Failure messages, refer to Check Control **78**
 False alarm, refer to Avoiding unintentional alarms **36**
 Fastening safety belts, refer to Safety belts **48**
 – warning lamp **49**
 Fastening system, adaptive **124**
 Fastest route for navigation **148**
 Fast forward
 – CD changer **178**
 – CD player **178**
 – DVD changer **183**
 "Fast route" for navigation **148**
 Fault displays, refer to Check Control **78**
 Filler neck for washer fluid **68**
 First-aid kit **256**
 Flashing during locking/unlocking, refer to Setting confirmation signals **31**
 Flashlight **119**
 Flat tire
 – changing wheels **251**
 – compact wheel **251**
 – Flat Tire Monitor **92**
 – run-flat tires **93, 95, 239**
 – TPM Tire Pressure Monitor **94**
 Flat Tire Monitor FTM **92**
 Fluid reservoir, refer to Filler neck for washer fluid **68**
 "FM", reception range **163, 166**

FM, waveband **166**
 Fog lamps **105**
 – indicator lamp **13, 105**
 Folding display screen open/closed, DVD system in rear **192**
 Folding rear seat backrest **123**
 Footbrake, refer to Braking safely **129**
 Footwell lamps **105**
 For your own safety **5**
 4-wheel drive system, refer to xDrive **90**
 Fresh-air nozzles, refer to Air vents **106**
 Front airbags **97**
 Front passenger airbags **97**
 – deactivating **98**
 – refer to Exception of front passenger seat **55**
 Front seat adjustment **43**
 FTM Flat Tire Monitor **92**
 – false alarms **92**
 – indicating a flat tire **93**
 – initializing the system **92**
 – malfunction **96**
 – snow chains **240**
 – system limits **92**
 – warning lamp **93**
 Fuel **233**
 – capacity **264**
 – display **72**
 – high-quality brands **233**
 – quality **233**
 – saving **128**
 – specifications **233**
 Fuel clock, refer to Fuel gauge **72**
 Fuel consumption display, computer, average fuel consumption **73**
 Fuel display, refer to Fuel gauge **72**
 Fuel filler door **232**
 – closing **232**
 – opening **232**
 – releasing manually **232**
 Fuses **253**

G

- Garage door opener, refer to Integrated universal remote control [115](#)
- Gasoline, refer to Required fuel [233](#)
- Gasoline display, refer to Fuel gauge [72](#)
- Gear changes, automatic transmission with Steptronic [65](#)
- General driving notes [128](#), [129](#)
- Glass sunroof, electric
 - convenient operation from outside [32](#)
 - convenient operation with comfort access [37](#)
 - remote control [30](#)
- Glove compartment [118](#)
 - lighting [118](#)
 - opening manually [118](#)
- GPS navigation, refer to Navigation system [136](#)
- Grills, refer to Ventilation [110](#)
- Grills of the automatic climate control [106](#)
- Gross vehicle weight, refer to Weights [264](#)

H

- Handbrake, refer to Parking brake [60](#)
 - Automatic Hold [61](#)
- Hands-free system, refer to Microphone [14](#)
- Hazard warning flashers [15](#)
- HDC Hill Descent Control [90](#)
- "HD radio" [169](#)
- HD radio, refer to High Definition Radio [169](#)
- Head airbags [97](#)
- Headlamp control, automatic [102](#)
- Headlamp flasher [66](#)
- Headlamps [102](#)
 - care, refer to Caring for your vehicle brochure
 - cleaning, refer to Washer/wiper system [67](#)
 - replacing bulbs [247](#)
- Head Light, refer to Adaptive Head Light [104](#)
- Head restraints [46](#)
 - sitting safely [42](#)
- "Head-Up Display" [100](#)
- Head-Up Display [99](#)
- Heated
 - mirrors [52](#)
 - rear window [108](#)
 - seats [50](#)
 - steering wheel [53](#)
- Heating [106](#)
 - exterior mirrors [52](#)
 - interior [106](#)
 - rear window [108](#)
 - residual heat [110](#)
 - seats [50](#)
 - steering wheel [53](#)
- Heating with engine switched off, refer to Residual heat [110](#)
- Heavy cargo, refer to Securing cargo [132](#)
- Height, refer to Dimensions [263](#)
- Height adjustment
 - seats [43](#)
 - steering wheel [52](#)
- High beams [66](#), [104](#)
 - headlamp flasher [66](#)
 - indicator lamp [13](#)
- High Definition Radio [169](#)
- Highs, refer to Treble and bass [163](#)
- High water, refer to Driving through water [129](#)
- Highway, refer to Route criteria [148](#)
- Hill Descent Control HDC [90](#)
- Hills [130](#)
- Holder for cups [120](#)

- Home address [148](#)
- "Home address" for navigation system [148](#)
- Homepage [4](#)
- Hood [241](#)
- Horn [10](#)
- Hot exhaust system [129](#)
- "Hour memo" [82](#)
- "House number" for destination entry [141](#)
- Hydraulic brake assistant, refer to Brake assistant [89](#)
- Hydroplaning [129](#)

I

- IBOC, refer to High Definition Radio [169](#)
- Ice, refer to Outside temperature warning [71](#)
- Ice warning, refer to Outside temperature warning [71](#)
- ID3 tag, refer to Information on track [177](#)
- Identification, tire [240](#)
- Identification mark, run-flat tires [239](#)
- iDrive [16](#)
 - assistance window [20](#)
 - changing language [83](#)
 - changing menu page [19](#)
 - changing settings [81](#)
 - changing units of measure and display type [82](#)
 - confirming selection or entry [19](#)
 - controller [16](#)
 - controls [16](#)
 - displays, menus [17](#)
 - selecting menu item [19](#)
 - setting brightness [82](#)
 - setting date [82](#)
 - setting time [81](#)
 - start menu [17](#)
 - status information [20](#)
 - symbols [18](#)

- Ignition [59](#)
 - switched off [59](#)
 - switched on [59](#)
 - Ignition key, refer to Keys/
remote control [28](#)
 - Ignition key position 1, refer to
Radio readiness [59](#)
 - Ignition key position 2, refer to
Ignition on [59](#)
 - Ignition lock [59](#)
 - starting engine with comfort
access [37](#)
 - Independent ventilation, refer
to Parked car ventilation [113](#)
 - Indicator/warning lamps [13](#)
 - active steering [96](#)
 - airbags [99](#)
 - DSC [13](#), [89](#)
 - DTC [90](#)
 - fasten safety belt [49](#)
 - Flat Tire Monitor [93](#)
 - fog lamps [13](#)
 - TPM Tire Pressure
Monitor [95](#)
 - Individual air distribution [109](#)
 - Individually programmable
buttons on steering
wheel [53](#)
 - Individual settings, refer to
Personal Profile [28](#)
 - Inflation pressure, refer to Tire
inflation pressure [234](#)
 - Inflation pressure monitoring
 - refer to FTM Flat Tire
Monitor [92](#)
 - refer to TPM Tire Pressure
Monitor [94](#)
 - Information
 - on another location [144](#)
 - on country [144](#)
 - on current position [144](#)
 - on destination location [144](#)
 - "Information on
destination" [145](#)
 - "Info sources" [76](#)
 - Initializing
 - Flat Tire Monitor [92](#)
 - refer to Power failure [253](#)
 - refer to Setting date [82](#)
 - refer to Setting time [81](#)
 - seat, mirror and steering
wheel memory [44](#)
 - "Input map" [143](#)
 - Installation location
 - drive for navigation DVD [136](#)
 - mobile phone [119](#)
 - Instructions for navigation
system, refer to Voice
instructions [153](#)
 - Instrument cluster, refer to
Instrument panel [12](#)
 - Instrument illumination, refer
to Instrument lighting [105](#)
 - Instrument lighting [105](#)
 - Instrument panel [12](#)
 - refer to Cockpit [10](#)
 - Integrated key [28](#)
 - Integrated universal remote
control [115](#)
 - Interesting destination for
navigation [144](#)
 - "Interim time" [80](#)
 - Interior lamps [105](#)
 - switching on with remote
control [30](#)
 - Interior motion sensor [36](#)
 - switching off [36](#)
 - Interior rearview mirror [52](#)
 - automatic dimming
feature [52](#)
 - compass [117](#)
 - Intermittent mode of the
wipers [67](#)
- ## J
- Jacking points [252](#)
 - Joystick
 - refer to iDrive [16](#)
 - refer to Selector lever,
selecting transmission
positions [64](#)
 - Jump starting [256](#)
- ## K
- Keyless-Go, refer to Comfort
access [36](#)
 - Keyless opening and closing,
refer to Comfort access [36](#)
 - Key Memory, refer to Personal
Profile [28](#)
 - "Keypad" [218](#)
 - Keys [28](#)
 - key-related settings, refer to
Personal Profile [28](#)
 - Kick-down, automatic
transmission with
Steptronic [65](#)
 - Knock control [233](#)
- ## L
- Lamps, refer to Parking lamps/
low beams [102](#)
 - Lamps and bulbs [247](#)
 - "Language / Units" [82](#), [83](#)
 - for navigation
system [137](#), [153](#)
 - "Language" for DVD system
in rear [196](#), [197](#)
 - "Languages" [83](#)
 - for navigation
system [137](#), [153](#)
 - Lashing eyes, refer to
Securing cargo [132](#)
 - Last destinations, refer to
Destination list [145](#)
 - "Last seat pos." [45](#)
 - LATCH child restraint fixing
system [56](#)
 - LEDs light-emitting
diodes [248](#)
 - Length, refer to
Dimensions [263](#)
 - License plate lamp, replacing
bulbs [250](#)

Liftgate **33**
– automatic operation **34**
– closing **33**
– locking and unlocking from inside **32**
– opening from inside **33**
– opening from outside **33**
– opening manually **33**
Light-emitting diodes
LEDs **248**
Lighter **121**
Lighter socket **121**
"Lighting" **67, 103**
Lighting
– instruments **105**
– lamps and bulbs **247**
– of the vehicle, refer to
Lamps **102**
Light switch **102**
"Limit" **80**
Loading
– securing cargo **132**
– stowing cargo **131**
– vehicle **131**
Load securing equipment,
refer to Securing cargo **132**
"Lock after driving" **32**
Lock buttons in the doors,
refer to Locking **32**
Locking
– from inside **32**
– setting confirmation
signals **31**
– using remote control **29**
– without key, refer to Comfort
access **36**
Locking and unlocking doors
– from inside **32**
– setting confirmation
signals **31**
Locking without key, refer to
Comfort access **36**
Low beams **102**
– automatic **102**
Lower back support, refer to
Lumbar support **44**

Lows, refer to Treble and
bass **163**
Lug bolts **252**
– tightening torque, refer to
After mounting **252**
– wrench **251**
Luggage compartment
capacity, refer to Cargo bay
capacity **264**
Luggage rack, refer to Roof-
mounted luggage rack **132**
Lumbar support **44**

M

M+S tires, refer to Winter
tires **240**
"Main menu" for DVD system
in rear **197**
Maintenance
– refer to Service and
Warranty Information
Booklet for US models **245**
– refer to Service
requirements **75**
– refer to Warranty and
Service Guide Booklet for
Canadian models **245**
Maintenance system **245**
Malfunction
– door lock **32**
– driver's door **32**
– fuel filler door **232**
– liftgate **33**
– panorama glass sunroof **40**
– parking brake **63**
Malfunction warnings, refer to
Check Control **78**
Manual air distribution **108**
Manually releasing
transmission lock **65**
Manual mode, automatic
transmission with
Steptronic **65**
"Manual" on the radio **167**
Manual operation
– door lock **32**
– driver's door **32**
– fuel filler door **232**
– transmission lock, automatic
transmission **65**
Map
– changing scale **152**
– destination entry **143**
"Map direction of travel" **152**
"Map facing north" **152**
Map facing north **152**
Master key, refer to Keys/
remote control **28**
Maximum cooling **109**
Maximum speed
– for winter tires **240**
– with compact wheel **253**
Memory, refer to Seat, mirror
and steering wheel
memory **44**
"Menu"
– for DVD system in
rear **185, 197**
– with rear
entertainment **183, 195**
Menus, refer to iDrive **16**
Message list for traffic
information **155**
Microfilter **111**
Microphone
– for mobile phone **14**
– for telephone **14**
– for voice command
system **14**
Mirror dimming feature **52**
Mirrors **51**
– automatic curb monitor **52**
– exterior mirrors **51**
– folding in and out **51**
– heating **52**
– interior rearview mirror **52**
– memory, refer to Seat, mirror
and steering wheel
memory **44**
"Missed calls" **216**
Missed calls **217**

- Mobile phone
 - accepted calls [217](#)
 - adjusting volume [214](#)
 - calling [215](#)
 - ending call [215](#)
 - installation location, refer to Center armrest [119](#)
 - missed calls [217](#)
 - operation via iDrive [214](#)
 - redialing [217](#)
 - refer to separate operating instructions
 - Top 8 [217](#)
 - touch tone dialing [218](#)
- Monitor, refer to iDrive [16](#)
- Monitoring tire pressure, refer to FTM Flat Tire Monitor [92](#)
- "Monitor on / off" [53](#)
- MP3, refer to Compressed audio files [175](#)
- Multifunction steering wheel, refer to Buttons on steering wheel [11](#)
- Multifunction switch
 - refer to Turn signals/headlamp flasher/high beams [66](#)
 - refer to Washer/wiper system [67](#)
- Music track, refer to Tracks [176](#)
- "Mute on / off" [53](#)

N

- "Navigation" [73](#), [138](#), [144](#)
- Navigation destination
 - entering manually [139](#), [141](#)
 - home address [148](#)
 - selecting via map [143](#)
- Navigation drive, installation location [136](#)
- Navigation DVD [136](#)
- Navigation instructions, refer to Switching voice instructions on/off [153](#)
- Navigation system [136](#)
 - address book [146](#)
 - changing route [154](#)
 - destination entry [138](#)
 - destination guidance in assistance window [136](#)
 - destination list [145](#)
 - displaying current position [157](#)
 - displaying route [151](#)
 - ending/continuing destination guidance [150](#)
 - entering a destination manually [139](#), [141](#)
 - last destinations [145](#)
 - navigation DVD [136](#)
 - opening [138](#)
 - route list [152](#)
 - searching for a special destination [144](#)
 - selecting destination using information [144](#)
 - selecting destination via map [143](#)
 - selecting route criteria [148](#)
 - starting destination guidance [150](#)
 - switching off, refer to Ending/continuing destination guidance [150](#)
 - voice instructions [153](#)
 - volume adjustment [154](#)
- "Navigation voice instructions" [53](#), [137](#)
- Neck support, refer to Head restraints [46](#)
- "New address" for navigation system [146](#)
- "New destination" [139](#), [143](#)
- New remote control [28](#)
- "New route" [154](#)
- New wheels and tires [239](#)
- "Next entertainment source" [53](#)
- "No video signal" for DVD system in rear [203](#)
- Nozzles, refer to Windshield washer nozzles [68](#)
- "NTSC color" for DVD system in rear [204](#)
- Nylon rope, refer to Tow-starting and towing [257](#)

O

- OBD socket [246](#)
- Octane ratings, refer to Fuel specifications [233](#)
- Odometer [71](#)
- Oil
 - additives, refer to Approved engine oils [243](#)
 - approved engine oils [243](#)
 - consumption, refer to Checking engine oil level [242](#)
 - level [242](#)
 - refilling, refer to Adding engine oil [243](#)
- Oil change interval, refer to Service requirements [75](#)
- "On a new destination" for navigation system [144](#)
- Onboard computer, refer to iDrive [16](#)
- "Onboard info" [73](#)
- Onboard toolkit [247](#)
- "On destination" [144](#)
- "On location" [144](#)
- Opening and closing
 - comfort access [36](#)
 - from inside [32](#)
 - panorama glass sunroof [39](#)
 - using remote control [29](#)
 - using the door lock [31](#)
- Operation by voice for mobile phone [219](#)
 - adjusting volume [220](#)
 - canceling [219](#)
 - correcting phone number [220](#)
 - dialing phone number [220](#)
 - placing a call [220](#)
 - redialing [221](#)
 - voice commands [219](#)
 - voice phone book [220](#)

Operation on poor roads [133](#)
"Options" [227](#)
Orientation menu, refer to
Start menu [17](#)
Outlet slits, refer to Air
vents [106](#)
Output, refer to Engine
data [262](#)
Outside air, refer to AUC
Automatic recirculated-air
control [109](#)
Outside temperature
display [71](#)
– changing unit of measure [82](#)
Outside temperature
warning [71](#)
"Overview" for DVD system in
rear [201](#)

P

Panic mode [30](#)
Panorama glass sunroof [39](#)
– moving manually [40](#)
– power failure [40](#)
– raising, opening, closing [39](#)
Park Distance Control PDC [84](#)
"Parked car operation" [113](#)
"Parked car ventilation" [113](#)
Parked car ventilation [113](#)
– activating activation
time [114](#)
– preselecting activation
times [114](#)
– switching on and off
directly [113](#)
Parking, vehicle [60](#)
Parking aid
– refer to PDC Park Distance
Control [84](#)
– refer to Rear view camera [86](#)
Parking assistant, refer to
PDC Park Distance
Control [84](#)
Parking brake [60](#)
– Automatic Hold [61](#)
– indicator lamp [13](#)
Parking lamps [102](#)
Parking with Automatic
Hold [62](#)
Parts and accessories [6](#)
"Passenger's seat climate" [51](#)
Passenger-side exterior
mirror, tilting down [52](#)
"Pathway lighting" [103](#)
Pathway lighting [103](#)
"Pause" for DVD system in
rear [198](#)
Paying attention to speed [240](#)
"PDC" [85](#)
"PDC in main window only" [85](#)
PDC Park Distance Control [84](#)
Personal Profile [28](#)
"Perspective" [152](#)
Phone book [214](#)
– creating and editing voice
phone book [220](#)
Phone numbers
– deleting from phone
book [217](#)
– dialing [215](#)
– most recent numbers [217](#)
– selecting in phone book [217](#)
– Top 8 [217](#)
"Photo" for DVD system in
rear [194](#), [200](#)
Pinch protection system
– panorama glass sunroof [40](#)
– power windows [38](#)
Plasters, refer to First-aid
kit [256](#)
"Play"
– for DVD system in rear [198](#)
– with satellite radio [173](#)
Playing videos, DVD system in
rear [195](#)
Plug-in unit for remote
control, refer to Ignition
lock [59](#)
Pocket light, refer to
Flashlight [119](#)
Position
– displaying [157](#)
– storing, refer to Storing
current position [146](#)
Power failure [253](#)

Power windows, refer to
Windows [38](#)
Preselecting activation times
of the parked car
ventilation [114](#)
"Presets"
– displaying with radio [166](#)
– with satellite radio [173](#)
Pressure, tires [234](#)
Pressure monitoring of tires,
refer to TPM Tire Pressure
Monitor [94](#)
"Profile" [229](#)
Programmable buttons on
steering wheel [53](#)
Programmable memory
buttons [21](#)
Protective function, refer to
Pinch protection system
– panorama glass sunroof [40](#)
– windows [38](#)

R

Radio
– Autostore [167](#)
– controls [162](#)
– High Definition Radio [169](#)
– listen to station [166](#)
– regional program [169](#)
– sampling stations [167](#)
– satellite radio [172](#)
– selecting frequency
manually [167](#)
– selecting
waveband [162](#), [166](#)
– station search [167](#)
– station with the best
reception [167](#)
– storing stations [168](#)
– switching on/off [162](#)
– tone control [163](#)
– volume [163](#)
– Weather Band [171](#)
Radio key, refer to Keys/
remote control [28](#)
Radio position, refer to Radio
readiness [59](#)

- Radio readiness **59**
 - switched off **59**
 - switched on **59**
 - with comfort access **37**
- Rain sensor **67**
- "Random"
 - for DVD system in rear **199**
 - refer to Random sequence **178**
- "Random all"
 - for DVD system in rear **200**
 - in audio mode **178**
- "Random directory"
 - for DVD system in rear **200**
 - in audio mode **178**
- Random sequence **178**
- "RDS" Radio Data System **169**
- Reading lamps **105**
- Rear automatic climate control **111**
 - activating on Control Display **112**
 - air supply **112**
 - switching off **112**
- "Rear climate control" **112**
- "Rear enabled" **192**
- Rear entertainment, refer to DVD system in rear **192**
- Rear lamps, refer to Tail lamps **249**
 - replacing bulbs **249**
- Rear seat backrest, folding **123**
- Rear seats
 - adjusting **47**
 - adjusting head restraints **47**
 - folding over backrest **123**
 - head restraint adjustment **47**
 - heating **50, 51**
- Rear socket **122**
- Rear ventilation **111**
 - rear automatic climate control **111**
 - 3rd row seats **111**
- Rear view camera **86**
 - cleaning **88**
 - displaying **88**
 - driver assistance functions **86**
 - switching off **86**
 - switching on **86**
- Rearview mirror **51**
- Rear window
 - heating **108**
 - replacing wiper blade **247**
 - windshield wiper **68, 130**
- Rear window safety switch **39**
- Rear window wiper, replacing wiper blade **247**
- "Received calls" **216**
- Recent numbers in mobile phone **217**
- Reception level of mobile phone, refer to Status information **20**
- Recirculated-air mode **109**
 - air recirculation **109**
 - AUC Automatic recirculated-air control **109**
- Reclining seat, refer to Seats **43**
- Recording times, refer to Stopwatch **80**
- "Redial" for mobile phone **216**
- Reflectors, refer to Tail lamps **249**
- Refueling **232**
- Releasing
 - hood **241**
 - refer to Unlocking **36**
- "Relock door if not opened" **32**
- Remaining distance, refer to Cruising range **73**
- Remaining distance to destination, refer to Computer **73**
- Remote control **28**
 - comfort access **36**
 - DVD system in rear **193**
 - garage door opener **115**
 - liftgate **30**
 - malfunction **31, 37**
 - replacing battery **38**
- Removing condensation on the windows **108**
- "Repeat"
 - for DVD system in rear **199**
 - in audio mode **178**
- "Repeat directory"
 - for DVD system in rear **198, 200**
 - in audio mode **178**
- "Repeat track"
 - for DVD system in rear **198, 200**
 - in audio mode **178**
- Replacement fuses **253**
- Replacement of tires **239**
 - changing wheels **251**
 - new wheels and tires **239**
- Replacing bulbs, refer to Lamps and bulbs **247**
- Replacing wheels/tires, refer to New wheels and tires **239**
- Replacing wiper blades **247**
- Reporting an accident, refer to Initiating an emergency request **255**
- Reporting safety defects **7**
- Reserve warning, refer to Fuel gauge **72**
- "Reset" **93, 95**
 - for DVD system in rear **196, 197**
 - stopwatch **80**
 - tone settings **165**
- Reset, refer to Resetting tone settings **165**
- "resetting FTM ..." **93**
- Residual heat **110**
- Restraint systems
 - for children **55**
 - refer to Safety belts **48**
- Retreaded tires **239**

"Return" for DVD system in rear [185](#), [197](#)

Reverse

- CD changer [178](#)
- CD player [178](#)
- DVD changer [183](#)

Reverse gear, automatic transmission with Steptronic [64](#)

Road map [152](#)

"Roadside Assistance" [224](#)

Roadside Assistance [256](#)

Roadside assistance [224](#)

Roadside parking lamps [104](#)

Roller sun blinds [118](#)

Roll-up cover [122](#)

Roof load capacity [264](#)

Roof-mounted luggage rack [132](#)

Rope, refer to Tow-starting and towing [257](#)

Rotary pushbutton, refer to iDrive [16](#)

Route [148](#)

- changing [154](#)
 - displaying [151](#)
 - displaying arrow display [151](#)
 - displaying map view [152](#)
 - displaying roads and towns/cities [152](#)
 - displaying towns/cities [152](#)
 - list [152](#)
 - selecting [148](#)
 - selecting criteria [148](#)
- RSC Runflat System
- Component, refer to Run-flat tires [239](#)
- Runflat System Component
- RSC, refer to Run-Flat Tires [239](#)
- Run-flat tires [239](#)
- continuing driving with a damaged tire [93](#), [95](#)
 - flat tire [93](#), [95](#)
 - new wheels and tires [239](#)
 - tire inflation pressure [93](#), [95](#), [234](#)
 - tire replacement [239](#)

S

Safety [5](#)

Safety belts [48](#)

- damage [49](#)
 - sitting safely [42](#)
 - warning lamp [49](#)
- Safety belt tensioners
- refer to Airbags [97](#)
 - refer to Safety belts [48](#)

Safety systems

- ABS Antilock Brake System [88](#)
- airbags [97](#)
- driving stability control systems [88](#)
- DSC Dynamic Stability Control [89](#)
- safety belts [48](#)

Safety tires, refer to Run-flat tires [239](#)

"SAT" [163](#), [172](#)

Satellite radio [172](#)

- displaying additional information [173](#)
 - enabling [172](#)
 - selecting channel [173](#)
 - storing channel [173](#)
- "Scan"
- for DVD system in rear [199](#)
 - sampling stations with radio [167](#)
 - sampling tracks with CD [177](#)

Scan

- CD changer [177](#)
- CD player [177](#)
- radio [167](#)

"Scan all"

- for DVD system in rear [200](#)
 - in audio mode [177](#)
- "Scan directory"
- for DVD system in rear [200](#)
 - in audio mode [177](#)

Screen, refer to iDrive [16](#)

Screw thread for tow fitting [257](#)

SDARS, refer to Satellite radio [172](#)

"Seat heater distribution" [50](#)

Seat heating [50](#)

Seats [43](#)

- adjusting [43](#)
- adjusting electrically [43](#)
- adjusting manually [43](#)
- backrest width [44](#)
- heating [50](#)
- in rear [47](#)
- lumbar support [44](#)
- memory, refer to Seat, mirror and steering wheel memory [44](#)
- shoulder support [44](#)
- sitting safely [42](#)
- storing the setting [44](#)
- thigh support [43](#), [44](#)
- ventilation, refer to Active seat ventilation and Seat heating [50](#)

2nd row seats [47](#)

Securing load

- refer to Securing cargo [132](#)
- with ski bag, refer to Securing cargo [125](#)

"Select as destination" [144](#), [227](#)

"Select current speed" [80](#)

Selecting audio source [162](#)

Selecting country for navigation [139](#)

Selecting frequency manually [167](#)

Selecting menu items [19](#)

Selecting new scale for navigation [152](#)

Selector lever, automatic transmission with Steptronic [64](#)

Selector lever lock, refer to Reverse gear [64](#)

Self-leveling suspension [92](#)

Service, refer to Roadside Assistance [256](#)

Service and Warranty Information Booklet for US models [245](#)

"Service Info" [76](#), [225](#), [242](#)

Service interval indicator, refer to Service requirements [75](#)

- "Service Request" 218, 225
- "Service requirements" 76, 225, 243
- Service requirements 75
- also refer to CBS Condition Based Service 245
- "Set date" 82
- "Set" on trip computer 74
- "Set service date" 77
- "Set time" 81
- "Settings" 229
- for unlocking 30
- Settings
- changing on Control Display 81
- clock, 12h/24h mode 82
- configuring, refer to Personal Profile 28
- Setting speed limit 80
- Setting time, refer to Preselecting activation times 114
- "SET" with rear entertainment 183, 195
- Shifting, automatic transmission with Steptronic 65
- Short commands of voice command system 265
- Shortest route in navigation, refer to Selecting route 148
- "Short route" for navigation 148
- Shoulder support 44
- "Show current position" 143
- "Show destination position" 143
- Shuffled, refer to Random
- CD changer 178
- CD player 178
- Side airbags 97
- Side marker lamps, replacing bulbs 248
- Signal horn, refer to Horn 10
- Sitting safely 42
- with airbags 42
- with head restraint 42
- with safety belts 42
- Ski bag 125
- Slide show, refer to Displaying images 200
- Sliding/tilt sunroof, refer to Panorama glass sunroof 39
- Slope assistant, refer to Starting assistant 91
- Smokers' package, refer to Ashtray 120
- Snow chains 240
- Socket for Onboard Diagnostics interface 246
- Socket for remote control, refer to Ignition lock 59
- Sockets, refer to Connecting electrical devices 121
- Soft closure aid, refer to Automatic soft closing 33
- Song search, refer to Sampling tracks 177
- SOS, refer to Initiating an emergency request 255
- Spare fuses 253
- Spare remote control 28
- Spare wheel
- refer to Changing wheels 251
- refer to Compact wheel 251
- Special oils, refer to Approved engine oils 243
- Specified oil grades, refer to Approved engine oils 243
- Speed
- with compact wheel 253
- with winter tires 240
- Speed-dependent volume 164
- Speed limit warning, refer to Speed limit 80
- Speedometer 12
- "Speed volume", refer to Tone control 164
- Sport program, automatic transmission with Steptronic 65
- Stability control, refer to Driving stability control systems 88
- "Standard" for DVD system in rear 197, 204
- "Star button" 54
- Star button 53
- Start/Stop button 59
- "Start" for stopwatch 80
- "Start guidance" 141
- Starting, refer to Starting engine 60
- Starting assistance, refer to Jump starting 256
- Starting assistant 91
- Starting difficulties, jump starting 256
- Starting off on slopes, refer to Starting assistant 91
- Start menu, iDrive 17
- "Start service" 224
- "Start Service" with BMW Assist 226
- "State / Province" for destination entry 139
- "State inspection" 77
- Station, refer to Radio 166
- "Status" 77
- Status of this Owner's Manual at time of printing 5
- Steering wheel
- adjusting 52
- automatic adjustment, refer to Steering wheel memory 44
- buttons on steering wheel 11
- easy entry/exit 53
- heating 53
- memory 44
- programmable buttons 53
- "Steering wheel buttons" 53
- Steering with variable ratio, refer to Active steering 96
- Steptronic, refer to Sport program and manual mode M/S 65
- "Stop" for stopwatch 80
- "Stopwatch" 80
- Stopwatch 80
- Storage compartments 119
- "Store"
- on the radio 168
- with satellite radio 174

"Store in address book" for navigation system [146](#)
 Storing current position [146](#)
 Storing radio stations [168](#)
 Storing sitting position, refer to Seat, mirror and steering wheel memory [44](#)
 Storing tires [240](#)
 "Street" for destination entry [140](#)
 "Subtitles" for DVD system in rear [197](#)
 Summer tires, refer to Wheels and tires [234](#)
 Switches, refer to Cockpit [10](#)
 Switching cooling function on and off [109](#)
 Switching off engine [60](#)
 Switching on
 – audio [162](#)
 – CD changer [162](#)
 – CD player [162](#)
 – radio [162](#)
 Switching on hour signal [82](#)
 Swiveling headlamps, refer to Adaptive Head Light [104](#)
 Symbols [4](#)
 – indicator/warning lamps [13](#)
 – navigation system [156](#)
 – traffic information with navigation system [154](#)

T

Tachometer [72](#)
 "Tailgate" [34](#)
 Tailgate [35](#)
 – opening from inside [33](#)
 – opening from outside [33](#)
 – opening manually [33](#)
 Tail lamps [249](#)
 – replacing bulbs [249](#)
 Tank contents, refer to Capacities [264](#)
 Target cursor for navigation [143](#)
 Technical alterations, refer to For your own safety [5](#)

Technical data [262](#)
 Telematic, refer to TeleService, BMW Assist [223](#)
 Telephone
 – refer to Mobile phone [208](#)
 – refer to separate operating instructions
 "Telephone list" [53](#)
 TeleService [225](#)
 Temperature
 – adjusting in upper body region [108](#)
 – adjusting with automatic climate control [108](#), [112](#)
 – changing units of measure [82](#)
 – refer to Coolant temperature [72](#)
 Temperature display
 – outside temperature [71](#)
 – setting units [82](#)
 – temperature warning [71](#)
 Temperature warning [71](#)
 Tempomat, refer to Cruise control [69](#)
 "Terminate services" [228](#)
 "Text language" [83](#)
 The individual vehicle [5](#)
 Third brake lamp, refer to Center brake lamp [250](#)
 3rd row seats [48](#)
 Tightening torque of the lug bolts, refer to After mounting [252](#)
 Tilt alarm sensor, switching off [36](#)
 Tilting down passenger-side exterior mirror [52](#)
 "Time" [81](#)
 "Time / Date" [81](#)
 "Time format" [82](#)
 Timer, refer to Preselecting activation times [114](#)
 "Timer 2" for parked car ventilation [114](#)
 "Timer 1" for parked car ventilation [114](#)

Tire inflation pressure monitoring, refer to Flat Tire Monitor [92](#)
 Tire inflation pressures [234](#)
 – checking [234](#)
 Tire Pressure Monitor TPM [94](#)
 Tire Quality Grading [237](#)
 Tires
 – age [237](#)
 – air loss [93](#), [95](#)
 – breaking-in [128](#)
 – changing [239](#)
 – condition [238](#)
 – damage [238](#)
 – flat tire, refer to Changing wheels [251](#)
 – inflation pressure [234](#)
 – inflation pressure monitoring, refer to FTM Flat Tire Monitor [92](#)
 – new wheels and tires [239](#)
 – pressure loss [93](#), [95](#)
 – pressure monitoring, refer to TPM Tire Pressure Monitor [94](#)
 – replacing [251](#)
 – retreaded tires [239](#)
 – run-flat tires [239](#)
 – size [237](#)
 – tread [238](#)
 – wear indicators [238](#)
 – wheel/tire combination [239](#)
 – winter tires [240](#)
 "Title" for DVD system in rear [197](#)
 TMC station, refer to Traffic information [154](#)
 "Tone" [163](#)
 – for DVD system in rear [197](#)
 Tone in audio mode
 – adjusting [163](#)
 – middle setting [165](#)
 "Tone left" for DVD system in rear [196](#)
 Tone on locking/unlocking [31](#)
 Tools, refer to Onboard toolkit [247](#)

- "Top 8" for mobile phone [216](#)
 - Torque
 - engine [262](#)
 - lug bolts, refer to After mounting [252](#)
 - Touch tone dialing [218](#)
 - Tow fitting [257](#)
 - Towing [257](#)
 - tow fitting [257](#)
 - "Town / City" for destination entry [139](#)
 - Town/city for destination entry [139](#)
 - Tow-starting [257](#), [258](#)
 - "TPM" [95](#)
 - TPM Tire Pressure Monitor [94](#)
 - resetting system [94](#)
 - system limits [94](#)
 - warning lamp [95](#)
 - Tracks
 - finding [177](#)
 - random sequence [178](#)
 - sampling, scan [177](#)
 - Track width, refer to Dimensions [263](#)
 - Traction-assist feature, refer to DSC Dynamic Stability Control [89](#)
 - Traction control, refer to DSC Dynamic Stability Control [89](#)
 - Traffic congestion
 - bypassing [157](#)
 - displaying traffic information [154](#)
 - Traffic information for navigation
 - depiction in route map [156](#)
 - displaying [155](#)
 - during destination guidance [157](#)
 - switching on/off [155](#)
 - symbols [156](#)
 - "Traffic Info settings" [155](#)
 - Transmission
 - automatic transmission with Steptronic [64](#)
 - manually releasing transmission lock on automatic transmission with Steptronic [65](#)
 - starting assistant [91](#)
 - Transmission positions, refer to Automatic transmission with Steptronic [64](#)
 - Transporting children safely [55](#)
 - Transport securing device, refer to Securing cargo [132](#)
 - Tread depth, refer to Minimum tread depth [238](#)
 - Treble, refer to Tone control [163](#)
 - "Treble / Bass" for DVD system in rear [197](#)
 - "Trip computer" [74](#)
 - Trip computer [74](#)
 - Trip-distance counter, refer to Trip odometer [71](#)
 - "Triple turn signal" [67](#)
 - Trip odometer [71](#)
 - Turning circle, refer to Dimensions [263](#)
 - Turn signals [66](#)
 - indicator lamp [12](#)
 - replacing bulbs [248](#)
- ## U
- Underbody protection, refer to Caring for your vehicle brochure
 - Uniform Tire Quality Grading/UTQR [237](#)
 - "Units" [83](#)
 - Units
 - average fuel consumption [82](#)
 - temperature [82](#)
 - Universal garage-door opener, refer to Integrated universal remote control [115](#)
 - Universal remote control [115](#)
 - "Unlock button" [30](#)
 - Unlocking
 - from inside [32](#)
 - liftgate [30](#)
 - using remote control [30](#)
 - without key, refer to Comfort access [36](#)
 - Unlocking and locking doors, using remote control [30](#)
 - Unlocking without key, refer to Comfort access [36](#)
 - "Unlock rear menu" for DVD system in rear [192](#)
 - "Update services" [227](#)
 - USB audio interface [189](#)
 - "USB" in audio mode [188](#), [190](#)
 - Used batteries
 - refer to Disposal [253](#)
 - refer to Replacing battery [38](#)
- ## V
- Valve screw caps, refer to After mounting [252](#)
 - Vehicle
 - battery [253](#)
 - breaking-in [128](#)
 - care [246](#)
 - care, refer to Caring for your vehicle brochure
 - decommissioning, refer to Caring for your vehicle brochure
 - loading [131](#)
 - measurements, refer to Dimensions [263](#)
 - parking [60](#)
 - washing, refer to Caring for your vehicle brochure
 - weights [264](#)
 - "Vehicle / Tires" for unlocking [30](#)
 - Vehicle jack [251](#)
 - jacking points [252](#)
 - Vehicle position, refer to Displaying current position [157](#)

Ventilation **110**

- draft-free **110**
- in the rear **111**
- rear automatic climate control **113**
- 3rd row seats **111**
- while stationary **113**

Vent outlets of automatic climate control **106**

Vents, refer to Ventilation **110**

"Vent settings" **109**

"Video settings" for DVD system in rear **196**

Voice, refer to Voice instructions for navigation system **153**

Voice command system **23**

- short commands **265**

Voice instructions for navigation system **153**

- muting **54, 154**
- repeating **54, 154**
- switching on/off **54, 153**
- volume **154**

Voice phone book **220**

Volume

- mobile phone **214**
- setting speed-dependent **164**
- voice instructions **154**

Volume distribution in audio mode

- front/rear **164**
- right/left **164**

Volume of warning tones **83**

W

Warning lamps, refer to Indicator and warning lamps **13**

Warning messages, refer to Check Control **78**

Warning tone, volume **83**

Warning triangle **255**

Warranty and Service Guide Booklet for Canadian models **245**

Washer/wiper system **67**

- rain sensor **67**
- washer fluid **68**
- windshield washer nozzles **68**

Washer fluid **68**

- capacity of the reservoir **69**

Washing the vehicle, also refer to Caring for your vehicle brochure

Water on roads, refer to Driving through water **129**

Waveband for radio **166**

"WB" **171**

Wear indicators in tires, refer to Minimum tread depth **238**

Weather Band **171**

Website **4**

Weights **264**

"Welcome light" **103**

Wheel/tire combination, refer to New wheels and tires **239**

Wheel/tire damage **238**

Wheelbase, refer to Dimensions **263**

Wheels and tires **234**

Width, refer to Dimensions **263**

Windows **38**

- convenient operation **30**
- convenient operation from outside **32**
- convenient operation with comfort access **37**
- opening, closing **38**
- pinch protection system **38**
- safety switch **39**

Windshield

- cleaning, refer to Washer/wiper system **67**
- defrosting, refer to Defrosting windows **108**
- displays, refer to Head-Up Display **99**

Windshield washer system

- refer to Washer/wiper system **67**
- windshield washer nozzles **68**

Windshield wipers, refer to Washer/wiper system **67**

- replacing wiper blades **247**

Winter tires **240**

- storage **240**

"With highways" for navigation system **148**

Word matching principle for navigation **149**

Working in the engine compartment **241**

Wrenches/screwdrivers, refer to Onboard toolkit **247**

X

xDrive **90**

Z

"Zoom" for DVD system in rear **197**

More about BMW

bmwusa.com



The Ultimate
Driving Machine

01 41 0 014 248 ue

